

REAR BUMPER

User Manual

2019-2023 RAM 1500(exclude RAM 1500 classic)



NRM03B101

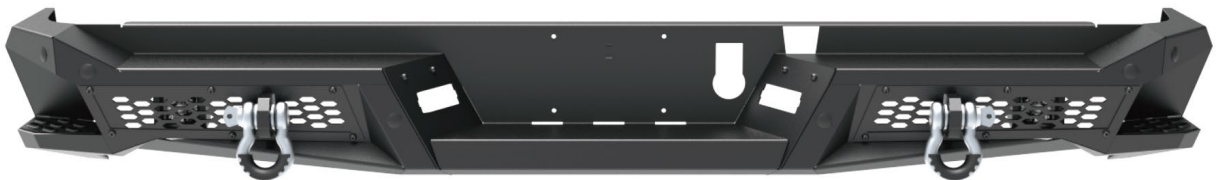

NRM03B102

Model:	NRM03B101	NRM03B102
Material:	Q235A	Q235A
Product Dimensions:	77.3 x 19.8 x 11.5 inch	76.9 x 18.3 x 10.8 inch
Package Dimensions:	33.9 x 24.8 x 13.8 inch	33.9 x 24.8 x 12.2 inch
Product Weight:	86.4 lbs	79.4 lbs

※ Thank you for purchasing the REAR BUMPER. Please read this manual carefully and keep it properly if you need to refer to it afterward. If you need any support or assistance, please contact us with your product model number and order number, and our support team will help you solve problems.





⚠ WARNING

※ This product is designed primarily to enhance the appearance of the vehicle. Do not rely in any way on the components of this product to protect against injury or death in the event of an accident. To reduce the risk of serious injury or property damage, please read all safety messages and understand all instructions and procedure notices before attempting to install or use this product.





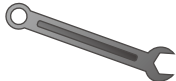

⚠ CAUTION



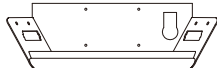
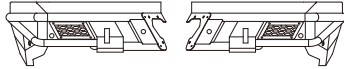
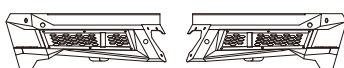
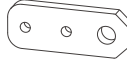

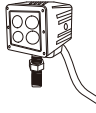





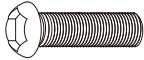

※ Properly torque and recheck fasteners and security of step tread after 250 miles and inspect frequently. Do not use if damaged.

REQUIRED TOOLS

Socket 	Ratchet 	Wrench 	Allen Wrench 	Safety Glasses 
---	--	---	--	---

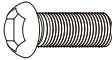
Parts Information

NO.		Parts Name	Size	Line Graph	Qty	Color
①	/	Mid Bumper	/		1	Black
②	101	Side Wings	/	 or 	1	Black
	102		/			
③	/	Trailer Hitch	/		2	Black
④	/	License Plate Lights Brackets	/		2	Black
⑤	/	Led lights	4inch		2	/
⑥	/	Cable Wires	2x0.75mm		2	/
⑦	/	Wire Connector Clips	/		8	/
⑧	/	Shackles	/		2	Blue Zinc Plating
⑨	/	Zip ties	/		10	Black

NO.		Parts Name	Size	Line Graph	Qty	Color
⑩	B35	Hex Bolts	M10x35		5	Dacro Black
⑪	W22	Spring Washer	Φ10		5	Dacro Black
⑫	W23	Flat Washer	Φ10x25x2		9	Dacro Black
⑬	N15	Hex Nuts	M10		5	Dacro Black
⑭	B15	Half Head Allen Bolts	M8x20		9	Dacro Black
⑮	N14	Hex Flange Nuts	M8		9	Dacro Black
⑯	B74	Half Head Allen Bolts	M6x35		7	Dacro Black
⑰	N11	Hex Lock Nuts	M6		9	Dacro Black
⑱	B06	Half Head Allen Bolts	M6x15		3	Dacro Black
⑲	B75	Hex Bolts	M12x45		5	Blue Zinc Plating
⑳	W29	Spring Washer	Φ12		5	Blue Zinc Plating
㉑	W28	Flat Washer	Φ12x30x3		5	Blue Zinc Plating
㉒	N24	Hex Nuts	M12		5	Blue Zinc Plating

NOTE:

Spare parts such as B35、 W22、 W23、 N15、 B15、 N14、 B74、 N11、 B06 、 B75、 W29、 W28 and N24 are provided with 1PCS each (included in the number of parts details).

Installation Instructions

Step 1: Open the carton and take out the parts. Check whether the number of components is complete.

Step 2: Remove the original bumper and prepare the parts needed to install the bumper.

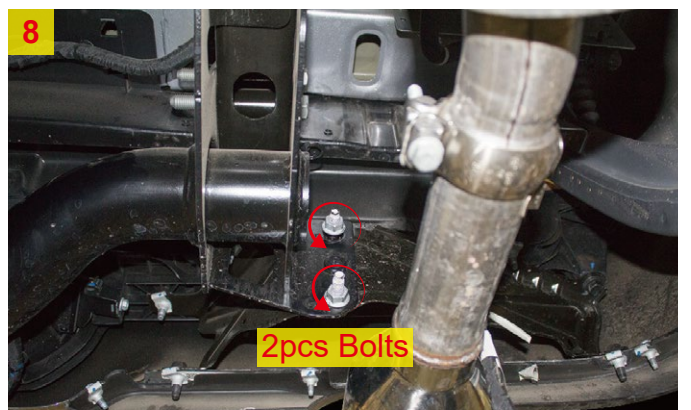
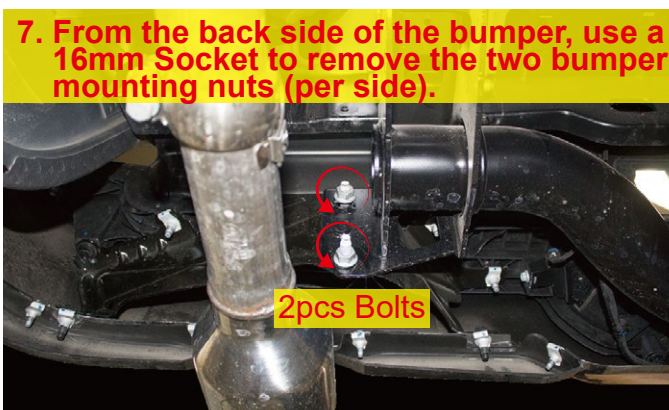
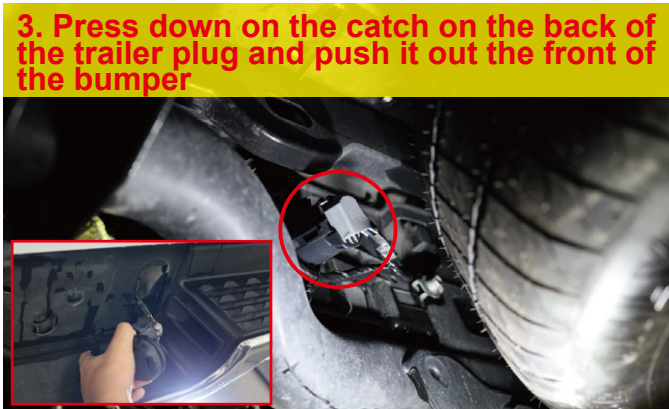

9. Remove the license plate, then remove the two bolts and two plastic clips behind the license plate.

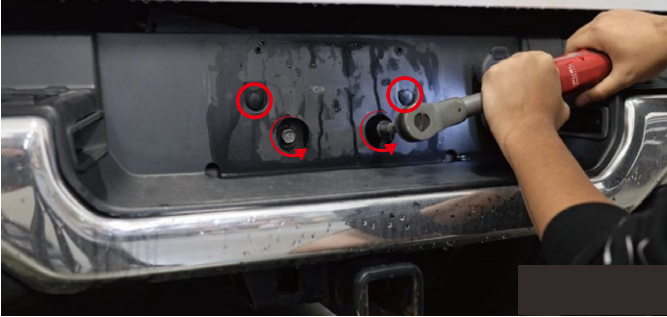

10. Remove the rear bumper.



11. Remove the radar probe.



12. Release the two fasteners by squeezing their tabs. Then, unplug the key sensor as you remove it from the bumper.

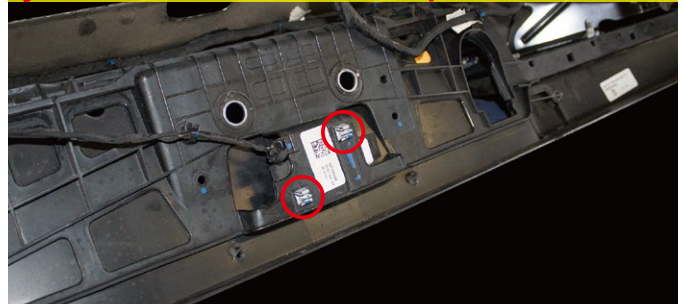

Step 3: Splicing the rear bumper.

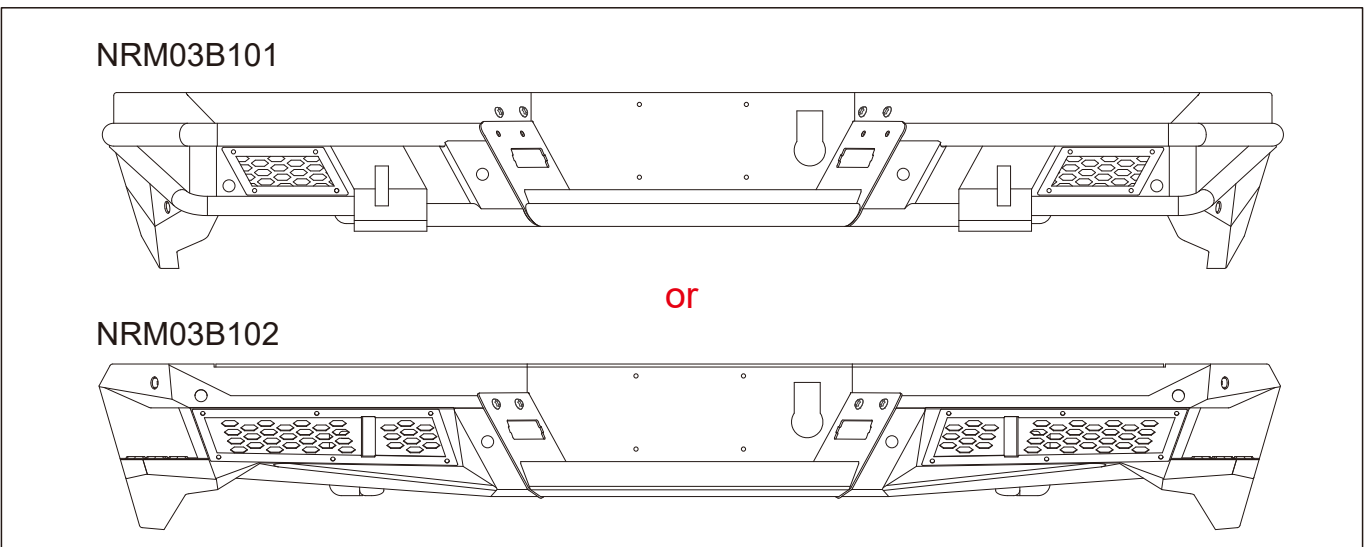
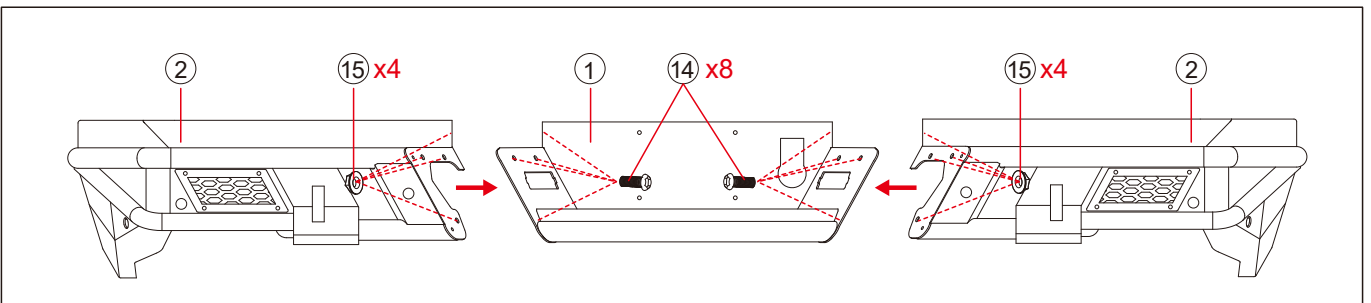
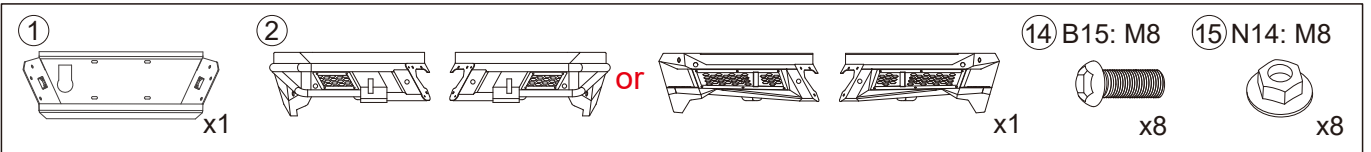

Step 4: Install the 4 Inch Led lights and Trailer Hitch.

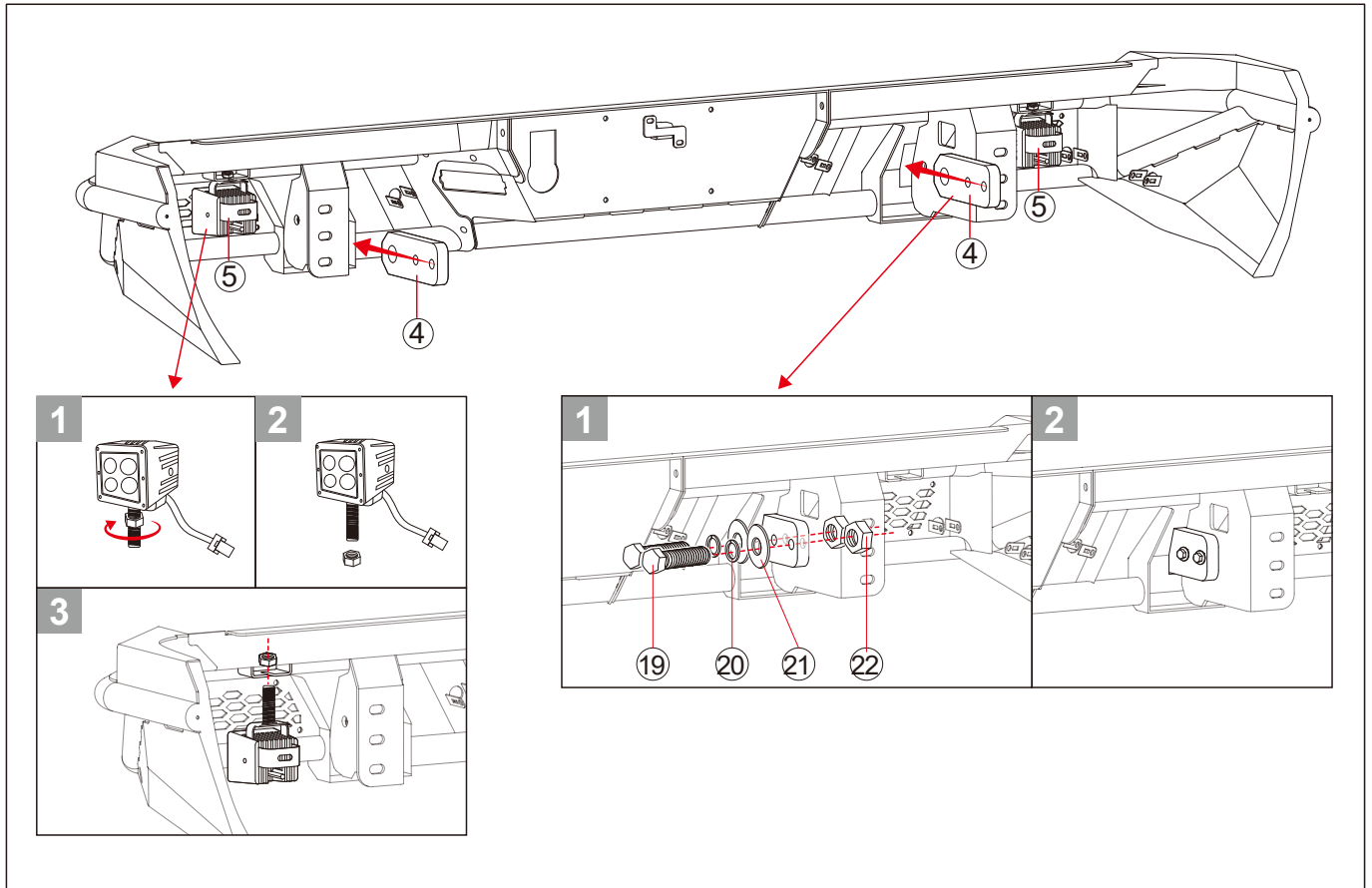
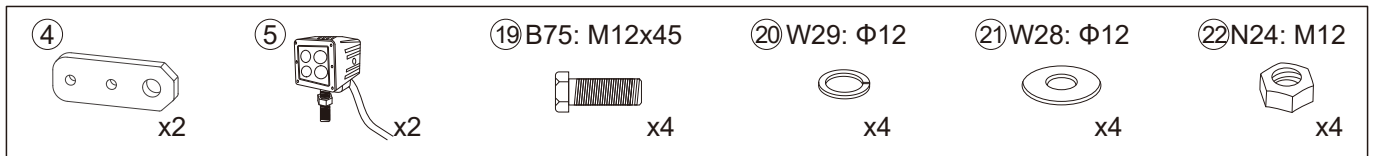

Step 5: Install the Shackles.

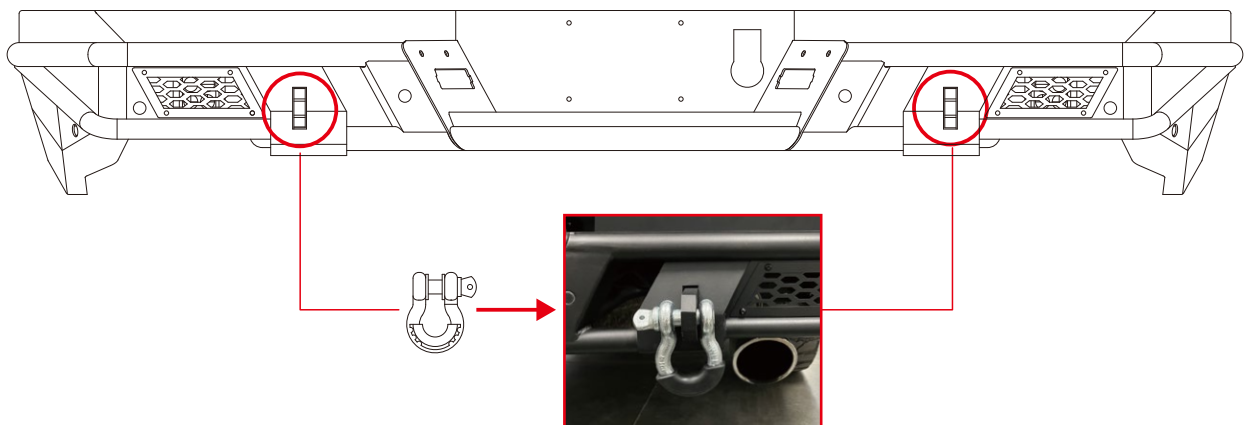

Step 6: Install the Radar Probe.

Note: If the car does not have a radar probe, this step can be ignored.

⑩ B74: M6x35



x6

⑪ N11: M6



x6

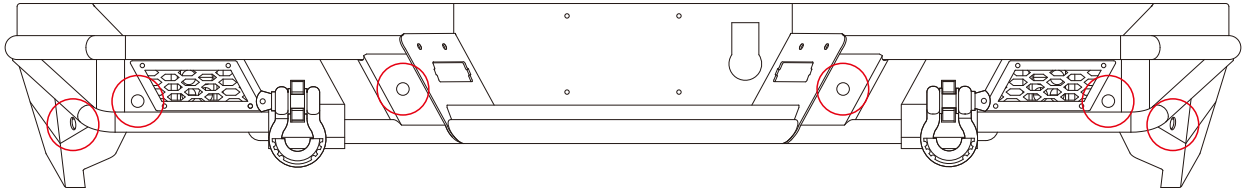

Back of bumper



Pull out the rubber stoppers



Rubber stopper



Radar probe install hole



Radar probe

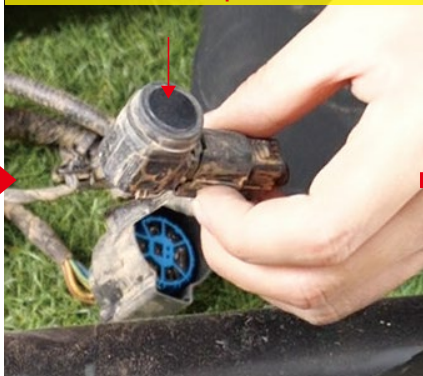

⑩ ⑪

Plates must be clamp the radar probe

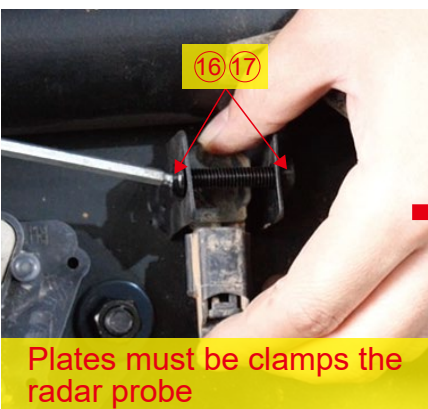

Installed successfully



Step 7: Install the license plate lights.

Note: DO NOT OVERTIGHTEN THE MOUNTING BOLTS OR YOU WILL BREAK THE LIGHT HOUSINGS. Tighten the bolts until the lights aren't loose anymore and stop.

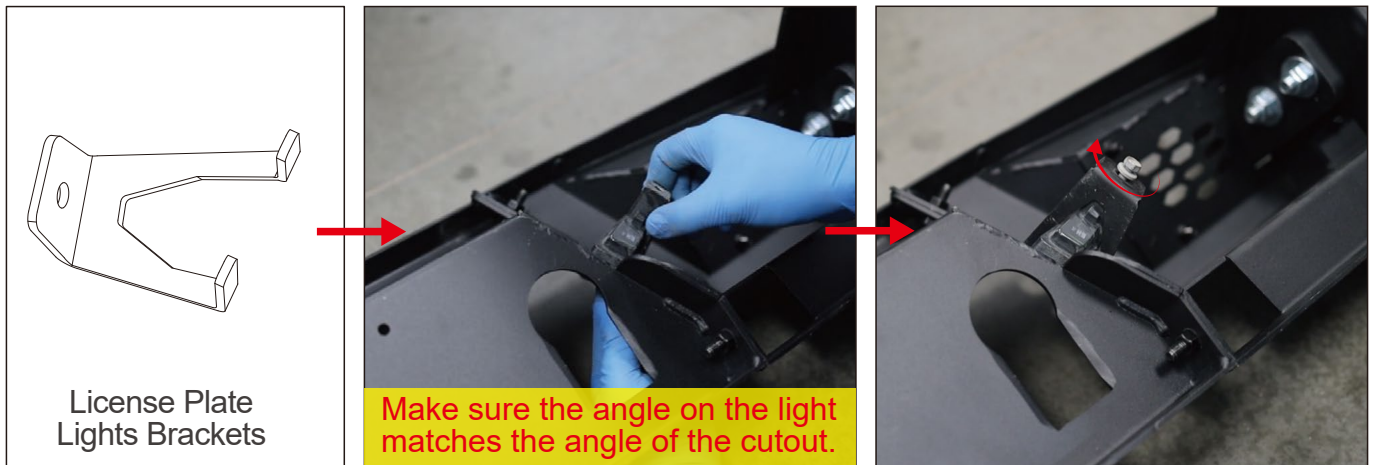

Step 8: Install the key sensor.

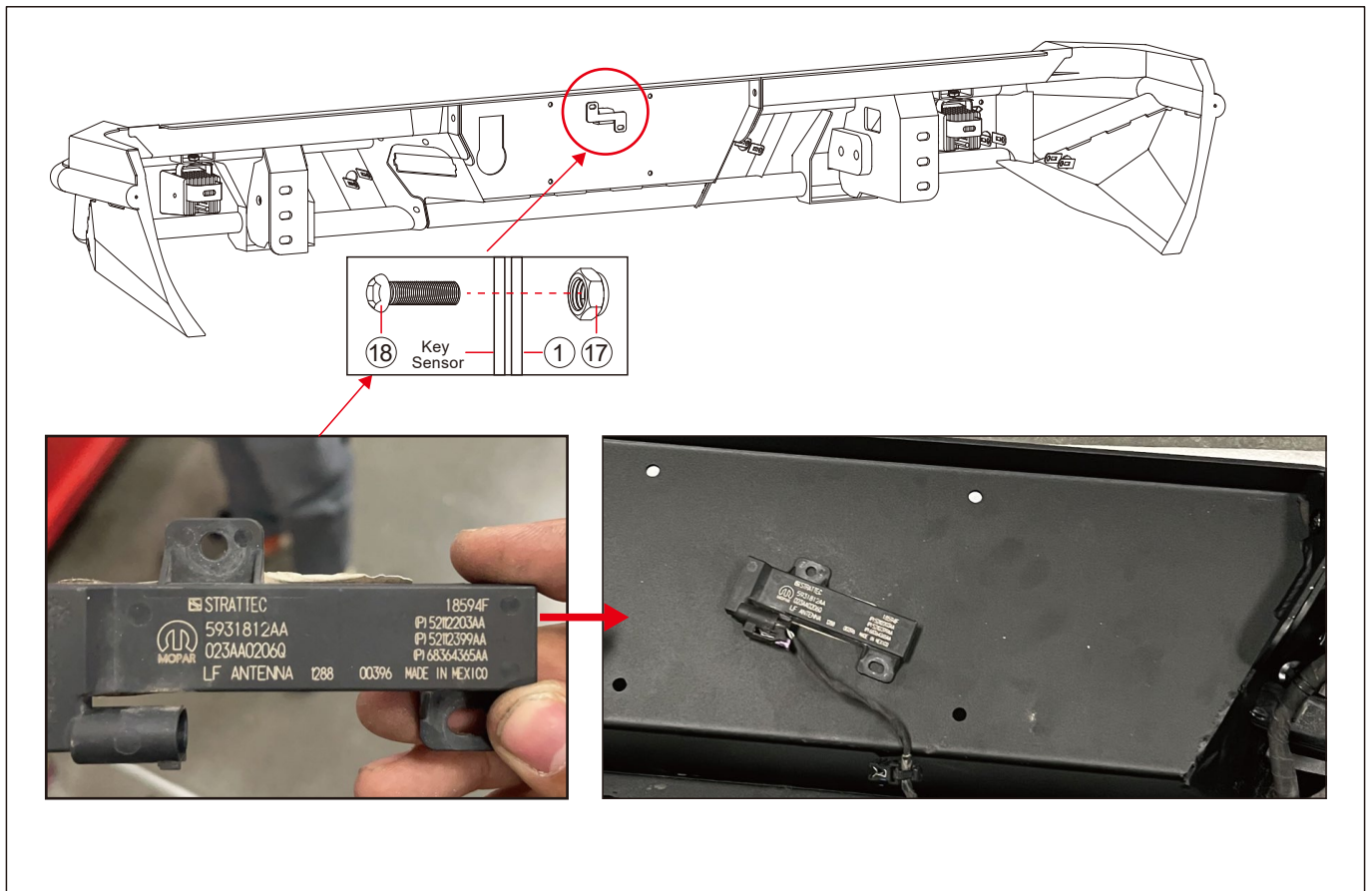

Step 9: Install the original 7-way trailer plug wiring harness.

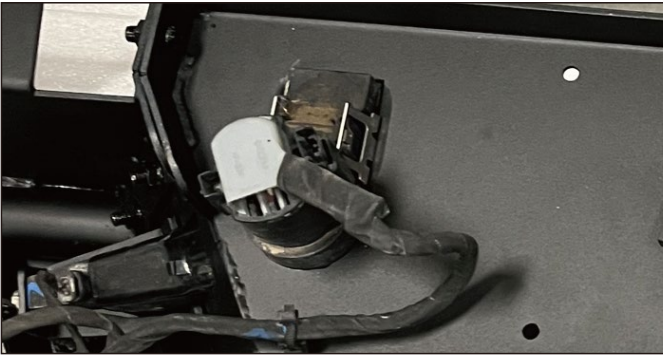

Step 10: Connect the Trailer plug wiring, 4inch Led lights and ⑥ Cabel wires.

7-Way Connector Wiring/Function Diagram

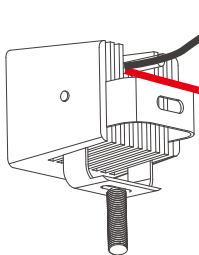
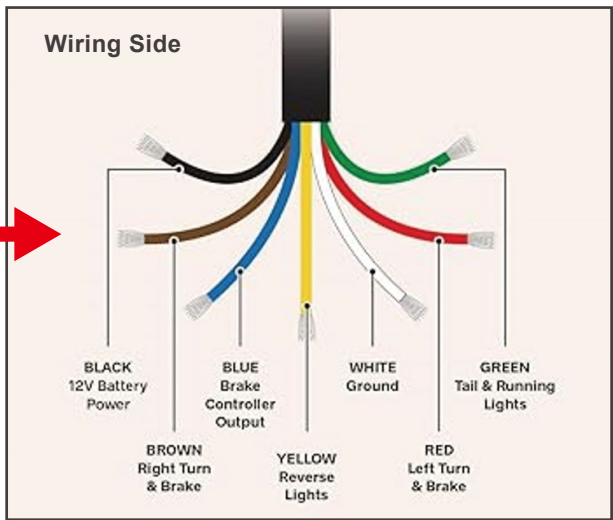
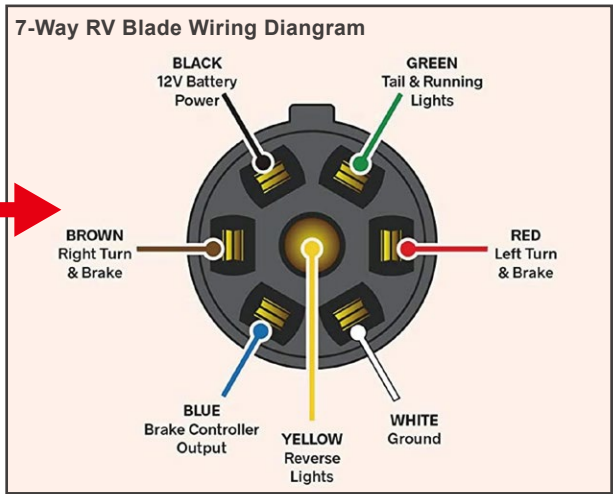

4inch Led light



Cabel wire

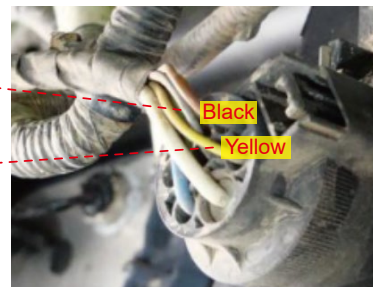

Trailer plug wiring

Step 11: Install the Rear Bumper.

⑩ B35: M10x35



x4

⑪ W22: $\Phi 10$



x4

⑫ W23: $\Phi 10$



x8

⑬ N15: M10



x4

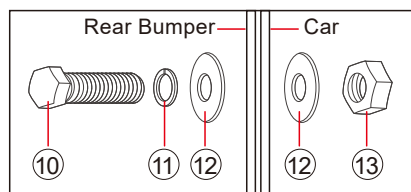

The Rear Bumper is installed

