

FRONT BUMPER SKID PLATE

————— User Manual —————

2013-2018 Ram 1500 Pickup Truck Excluding Rebel
2019-2023 Dodge Ram 1500 Excluding Warlock



Model:	NRM01A104-4
Material:	Q235A
Product Dimensions:	34.3 x 27.2 x 7.1 inch
Package Dimensions:	40.8 x 16.3 x 7 inch
Product Weight:	46.3 lbs

※ Thank you for purchasing the FRONT BUMPER Skid Plate. Please read this manual carefully and keep it properly if you need to refer to it afterward. If you need any support or assistance, please contact us with your product model number and order number, and our support team will help you solve problems.





⚠ WARNING

※ This product is designed primarily to enhance the appearance of the vehicle. Do not rely in any way on the components of this product to protect against injury or death in the event of an accident. To reduce the risk of serious injury or property damage, please read all safety messages and understand all instructions and procedure notices before attempting to install or use this product.



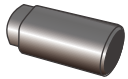

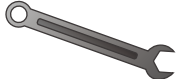

⚠ CAUTION

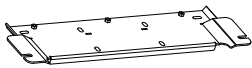
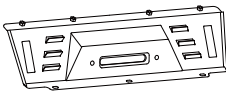
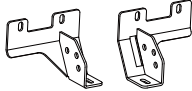

※ Properly torque and recheck fasteners and security of step tread after 250 miles and inspect frequently. Do not use if damaged.

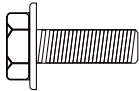
REQUIRED TOOLS

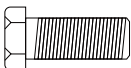
Socket 	Ratchet 	Wrench 	Allen Wrench 	Safety Glasses 
---	--	---	--	---

Parts Information

NO.	Parts Name	Size	Line Graph	Qty	Color
/	Winch Bracket	/		1	Black
/	Skid Plate	/		1	Black
/	Bracket	/		1	Black
/	Shackles Bracket	/		2	Black
B22	Hex Flange Bolts	M8x25		8	Dacro Black
W22	Spring Washer	Φ10		3	Dacro Black
W23	Flat Washer	Φ10x25x2		3	Dacro Black
B35	Hex Bolts	M10x35		3	Dacro Black
N15	Hex Nuts	M10		3	Dacro Black
W25	Spring Washer	Φ12		9	Dacro Black

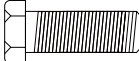
NO.	Parts Name	Size	Line Graph	Qty	Color
W27	Flat Washer	Φ12x30x3		9	Dacro Black
B69	Hex Bolts	M12x35x1.5		3	Dacro Black
N19	Hex Nuts	M12		7	Dacro Black
B37	Hex Bolts	M12x35		7	Dacro Black

※**Note:**

Spare parts such as B22、 W22、 W23、 B35、 N15、 W25、 W27、 B69 、 N19、 B37 are provided with 1PCS each (included in the number of parts details).

Installation Instructions

Step 1: Open the carton and take out the parts. Check whether the number of components is complete.

Step 2: Install the Bracket.

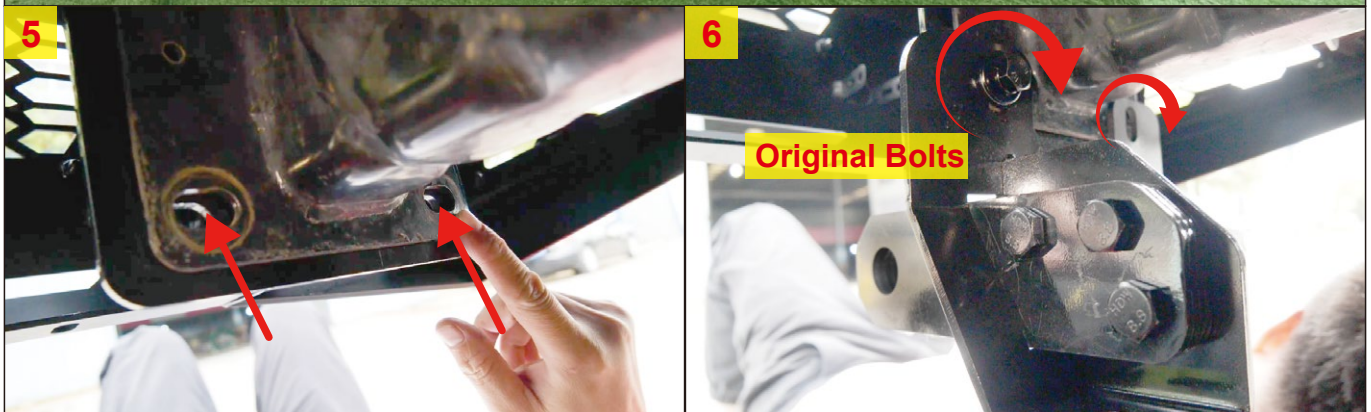
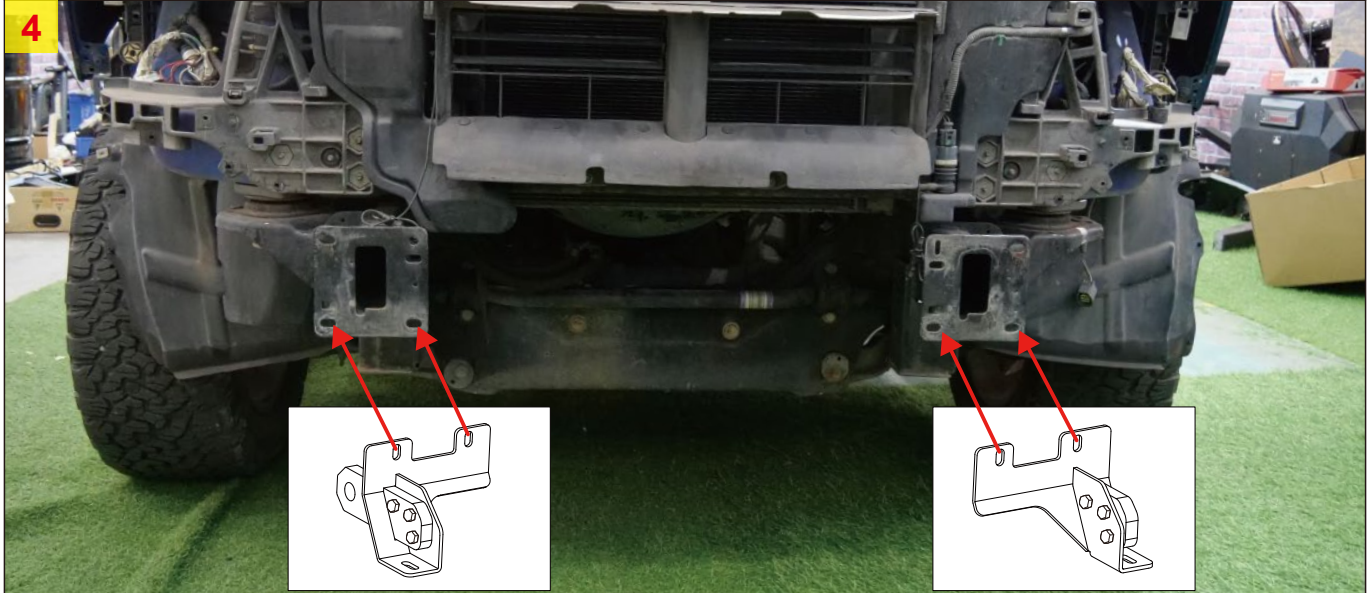
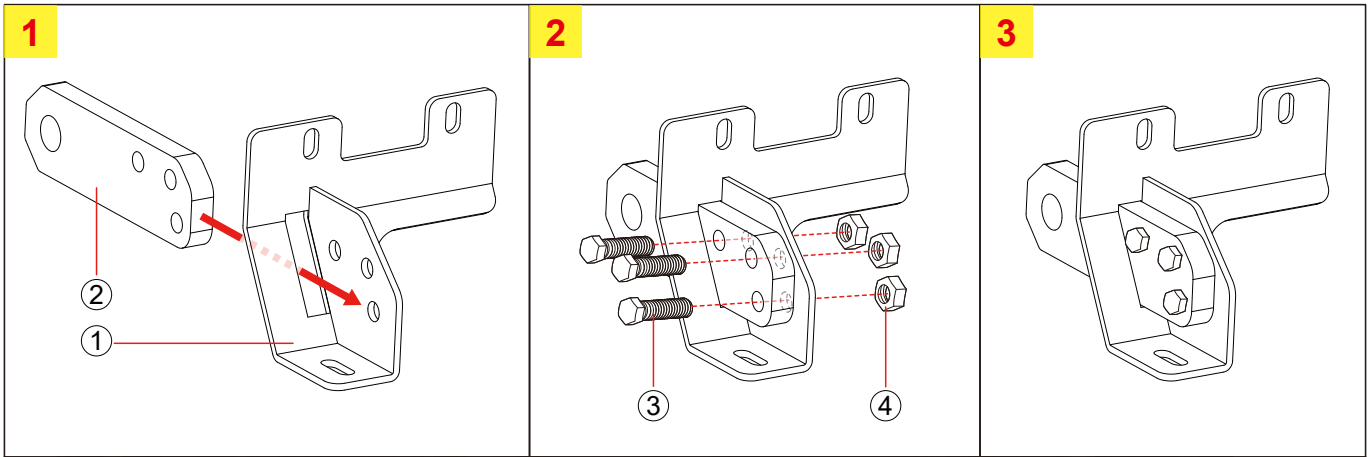

Step 3: Install the Winch Bracket.

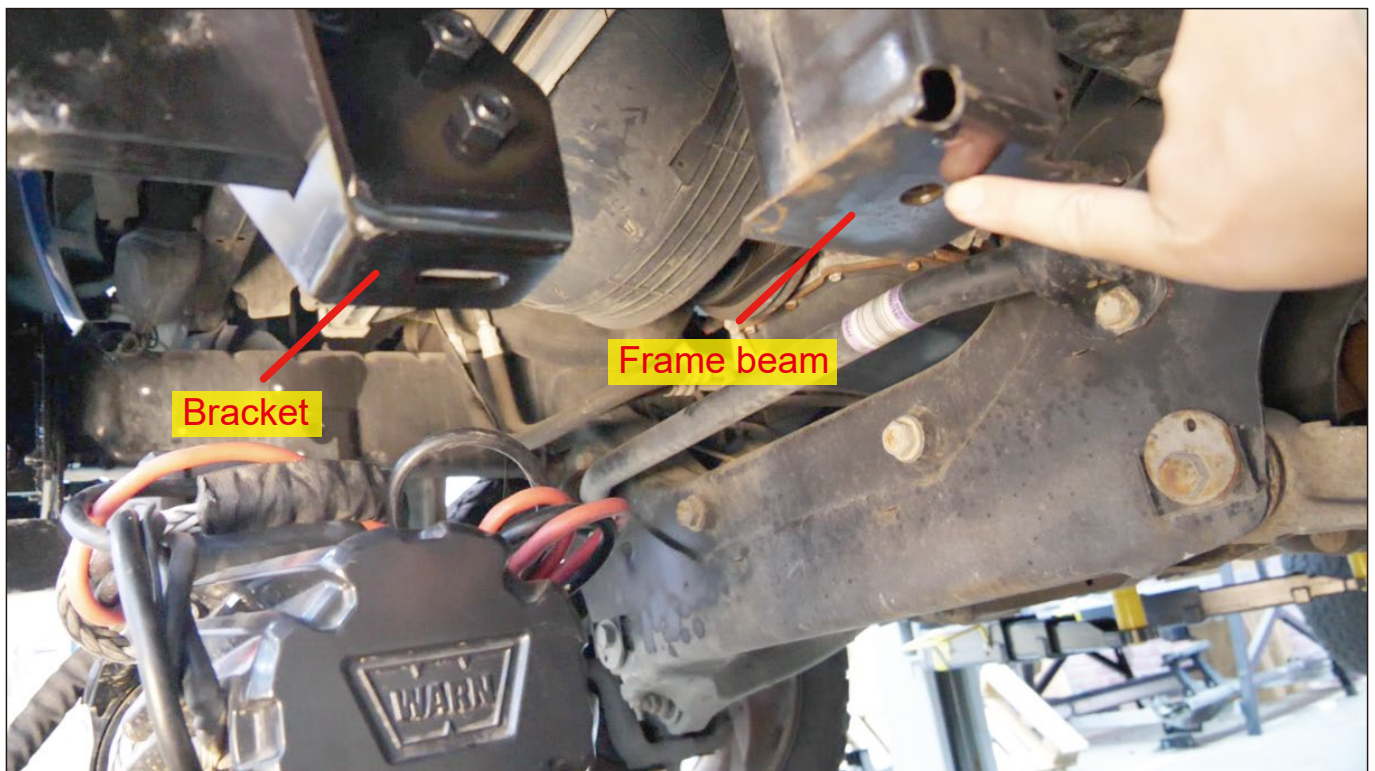
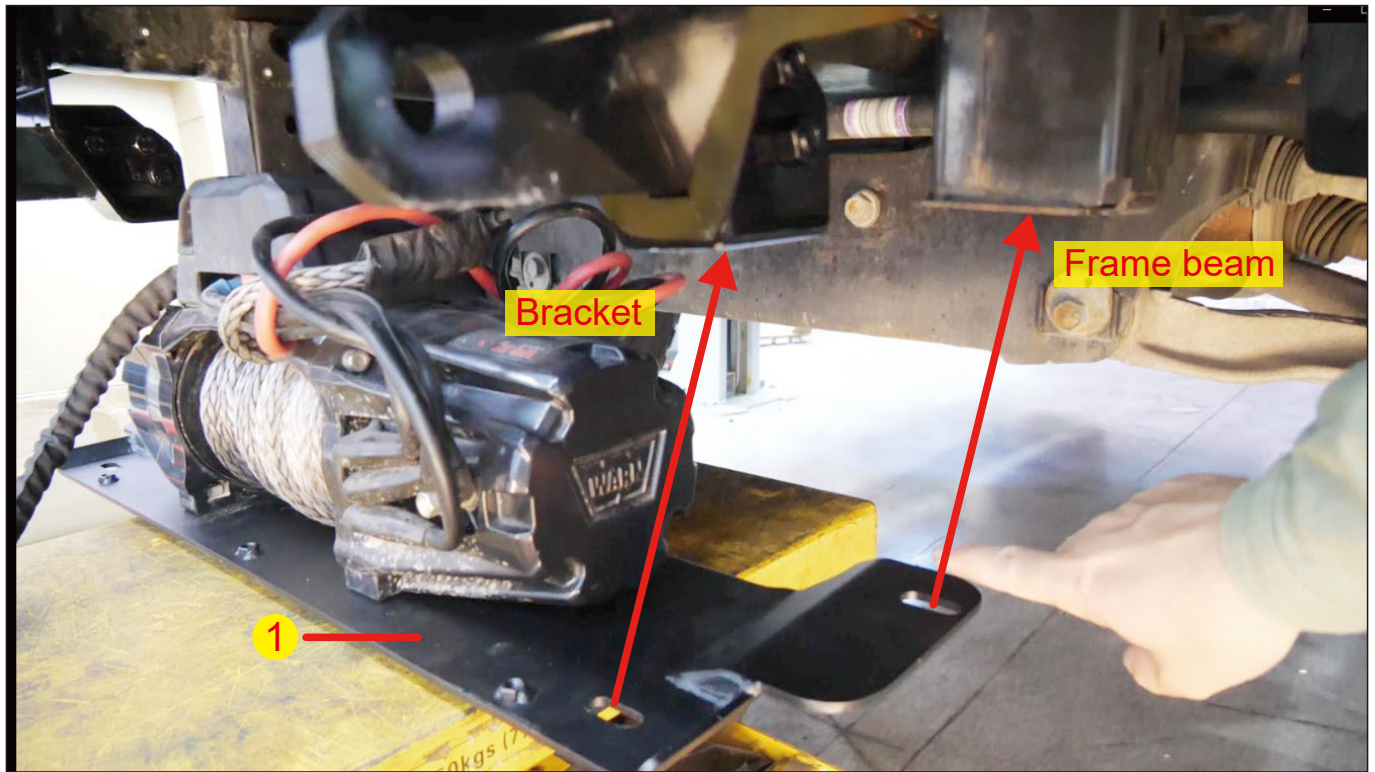
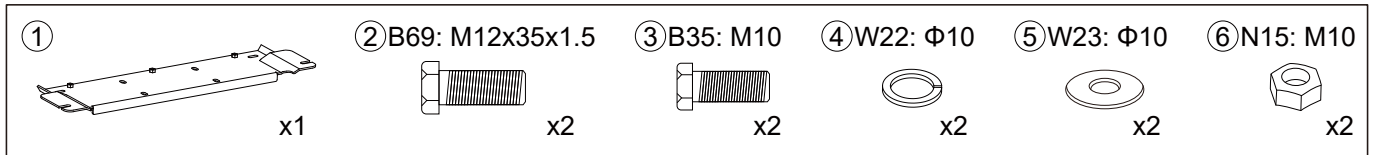

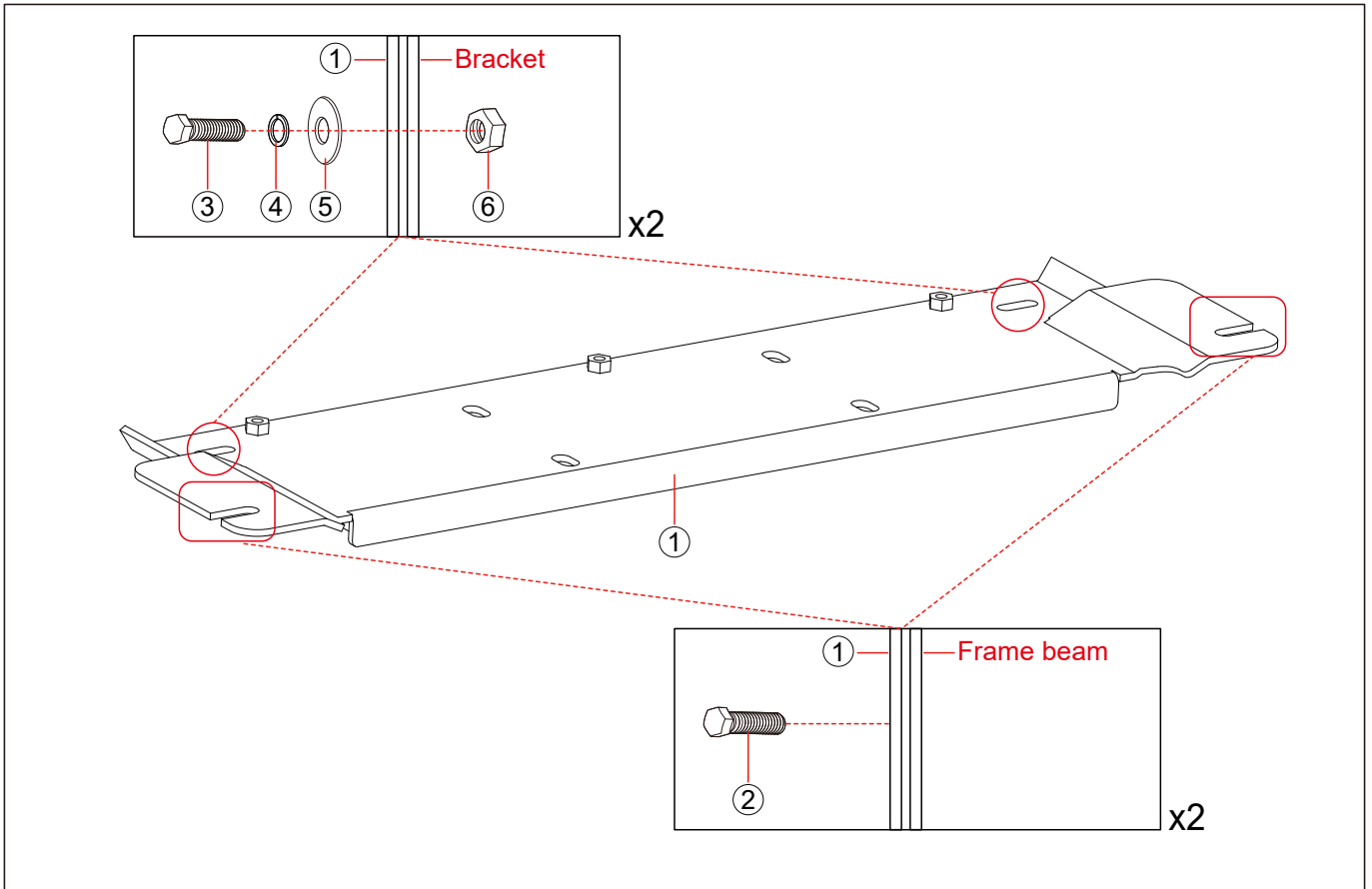

Step 4: Install the Skid Plate.

