

FRONT FENDER FLARES

————— User Manual —————

2019-2022 Wrangler JT

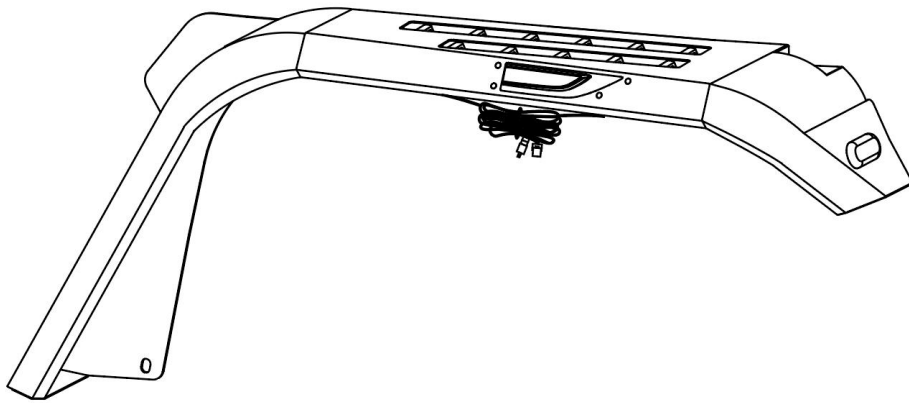

Model:	NJT01H101-F
Material:	Q235A
Product Dimensions:	44.3 x 12.4 x 19.8 inch
Package Dimensions:	56.3 x 21.7 x 13.4 inch
Product Weight:	45.64 lbs

※ Thank you for purchasing the FENDERS FLARES. Please read this manual carefully and keep it properly if you need to refer to it afterward. If you need any support or assistance, please contact us with your product model number and order number, and our support team will help you solve problems.





⚠ WARNING

※ This product is designed primarily to enhance the appearance of the vehicle. Do not rely in any way on the components of this product to protect against injury or death in the event of an accident. To reduce the risk of serious injury or property damage, please read all safety messages and understand all instructions and procedure notices before attempting to install or use this product.





⚠ CAUTION

※ Properly torque and recheck fasteners and security of step tread after 250 miles and inspect frequently. Do not use if damaged.

REQUIRED TOOLS

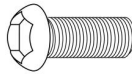
Socket 	Ratchet 	Allen Wrench 	Safety Glasses 
--	---	--	--

Parts Information

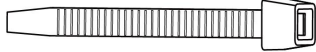
Parts NO.	Parts Name	Size	Line Graph	Qty	Color
/	Front Fender Flares	/		2	Black
B15	Half Head Allen Bolts	M8x20		20	Dacro Black
W19	Flat Washer	Φ8x24x2mm		20	Dacro Black
N14	Hex Flange Nuts	M8		20	Dacro Black
/	Nylon Washer	Φ8x16x0.5		20	Black
/	Ribbon	5x250		10	Black

***Note: spare parts such as B15、W19、N14 are provided with 2PCS each (included in the number of parts details).**

Installation Instructions

Step 1: Open the carton and take out the parts. Check whether the number of components is complete.

Step 2: Remove the original front fender flares and original front inner fender flares and prepare the parts needed to install the Front Inner Fender Flares.



Step 3: Install the front fender flares and tighten the bolts.

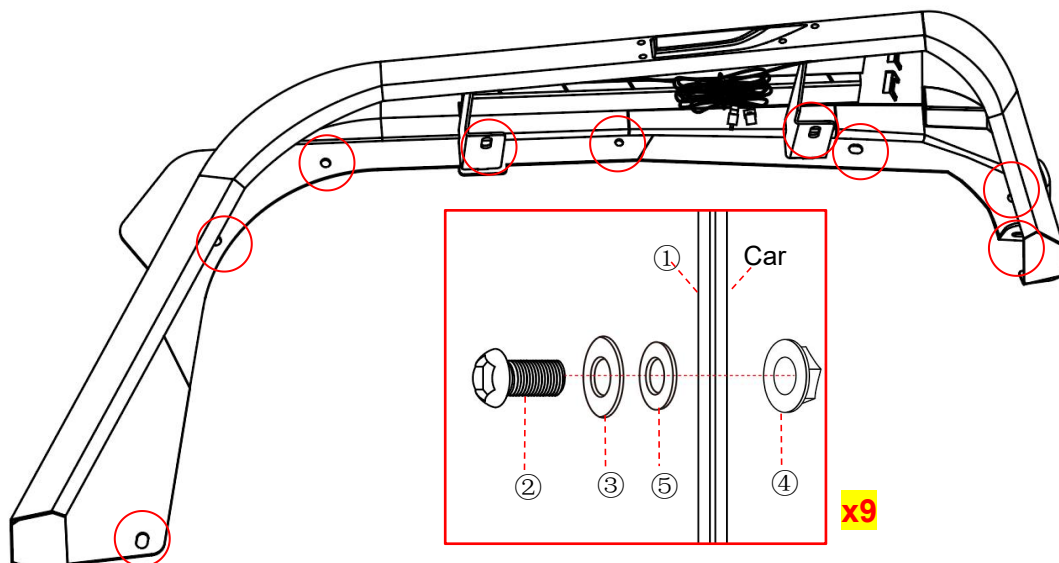
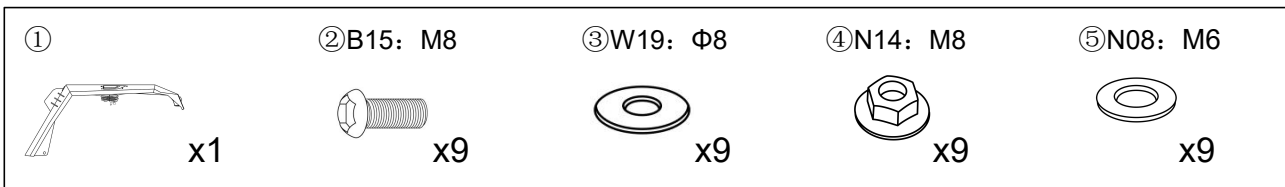

Step 4: Connect the front fender flares light wiring.

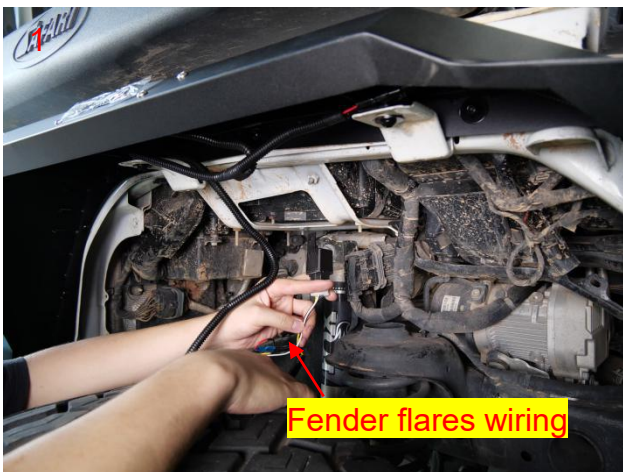
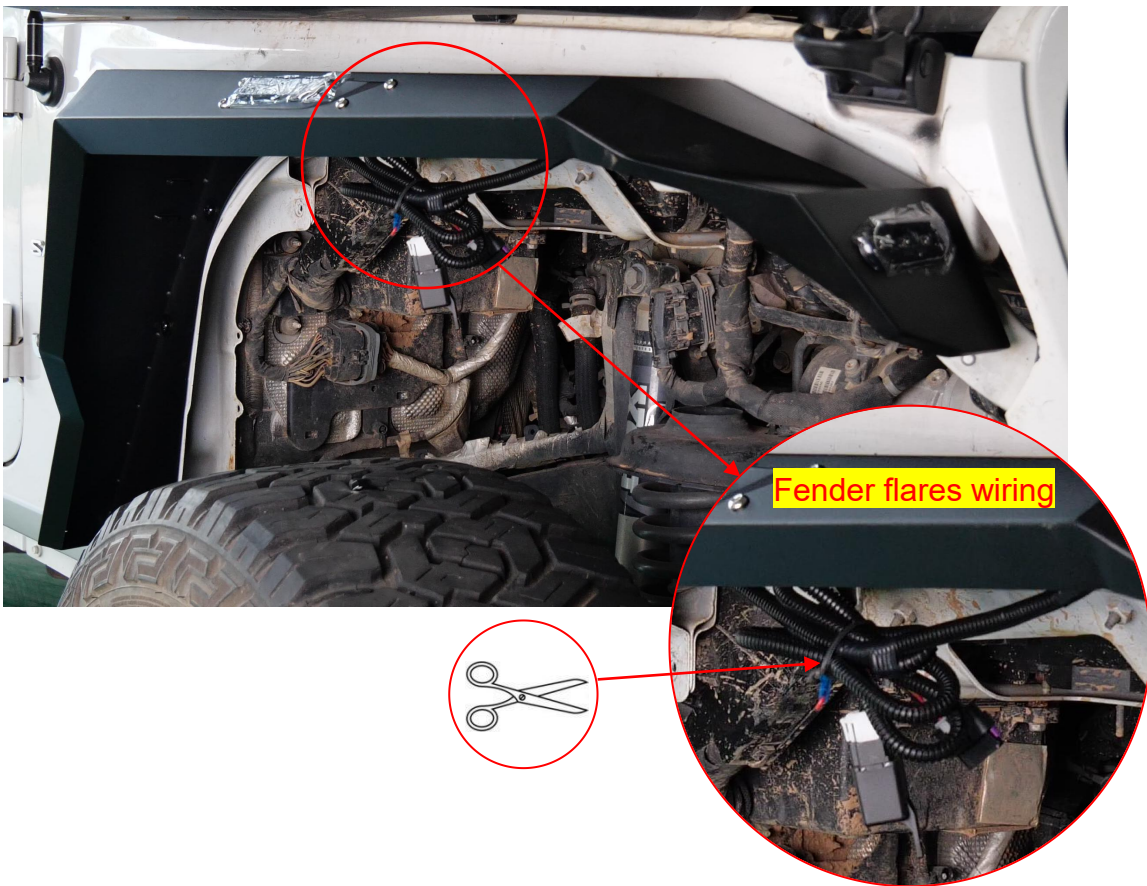

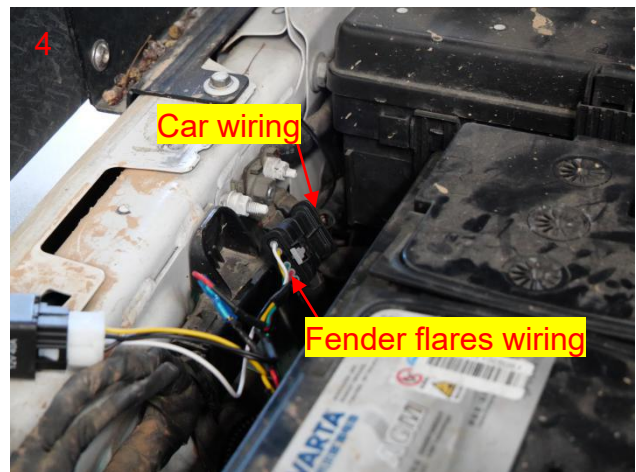

Step5: Bundling wires.

Step 6: Installation of a front fender flares is complete. Please do periodic inspections of the fender flares to make sure that all hardware is secure and tight.

Step 7: Install the original front fender flares.