

FENDER FLARES (FRONT + REAR)

————— User Manual —————

2021-2023 Ford Bronco(not Bronco Sport)



Model:	NFB01H104
Material:	Q235A
Product Dimensions:	42.3 x 7.8 x 14.6 inch
Package Dimensions:	45.3 x 28.7 x 7.5 inch
Product Weight:	48.5 lbs

※ Thank you for purchasing the FENDER FLARES (FRONT +REAR). Please read this manual carefully and keep it properly if you need to refer to it afterward. If you need any support or assistance, please contact us with your product model number and order number, and our support team will help you solve problems.





⚠ WARNING

※ This product is designed primarily to enhance the appearance of the vehicle. Do not rely in any way on the components of this product to protect against injury or death in the event of an accident. To reduce the risk of serious injury or property damage, please read all safety messages and understand all instructions and procedure notices before attempting to install or use this product.



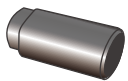

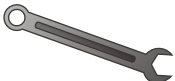



⚠ CAUTION

※ Properly torque and recheck fasteners and security of step tread after 250 miles and inspect frequently. Do not use if damaged.

REQUIRED TOOLS

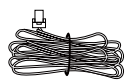
Socket 	Ratchet 	Wrench 	Allen Wrench 	Safety Glasses 
---	--	---	--	---

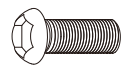
Parts Information

NO.	Parts Name	Size	Line Graph	Qty	Color
/	Left&Right Front Fender Flares	/		1	Black
/	Left&Right Rear Fender Flares	/		1	Black
/	Left&Right Light brackets	/		1	Black
/	Wire sets brackets	/		2	Black
/	Wire sets	/		2	Black
/	Line Card	/		4	Black
B66	Half Head Allen Bolts	M6x25		27	Dacro Black
N09	Hex Flange Nuts	M6		27	Dacro Black
W19	Wire connector clips	Φ8x24x2		5	Dacro Black

※ **Note:**

Spare parts such as B66、N09、W19 are provided with 1PCS each (included in the number of parts details).

Installation Instructions

Step 1: Open the carton and take out the parts. Check whether the number of components is complete.

Step 2: Remove the original Front Fender Flares.



Step 3: Remove the original Rear Fender Flares.

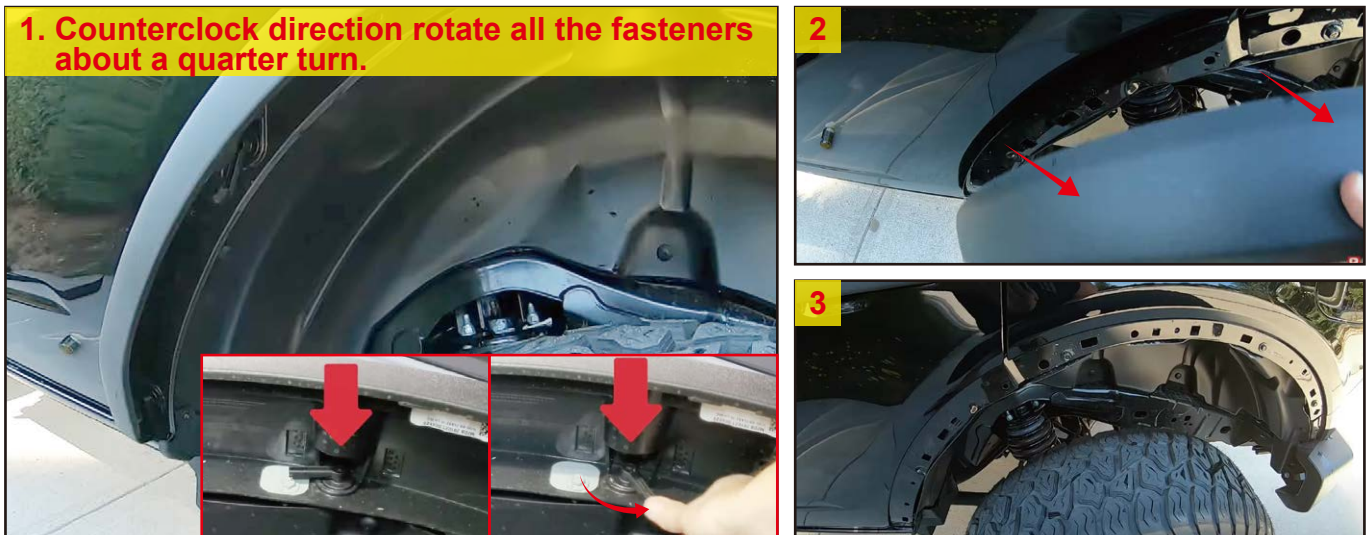

Step 4: Install the Light brackets.

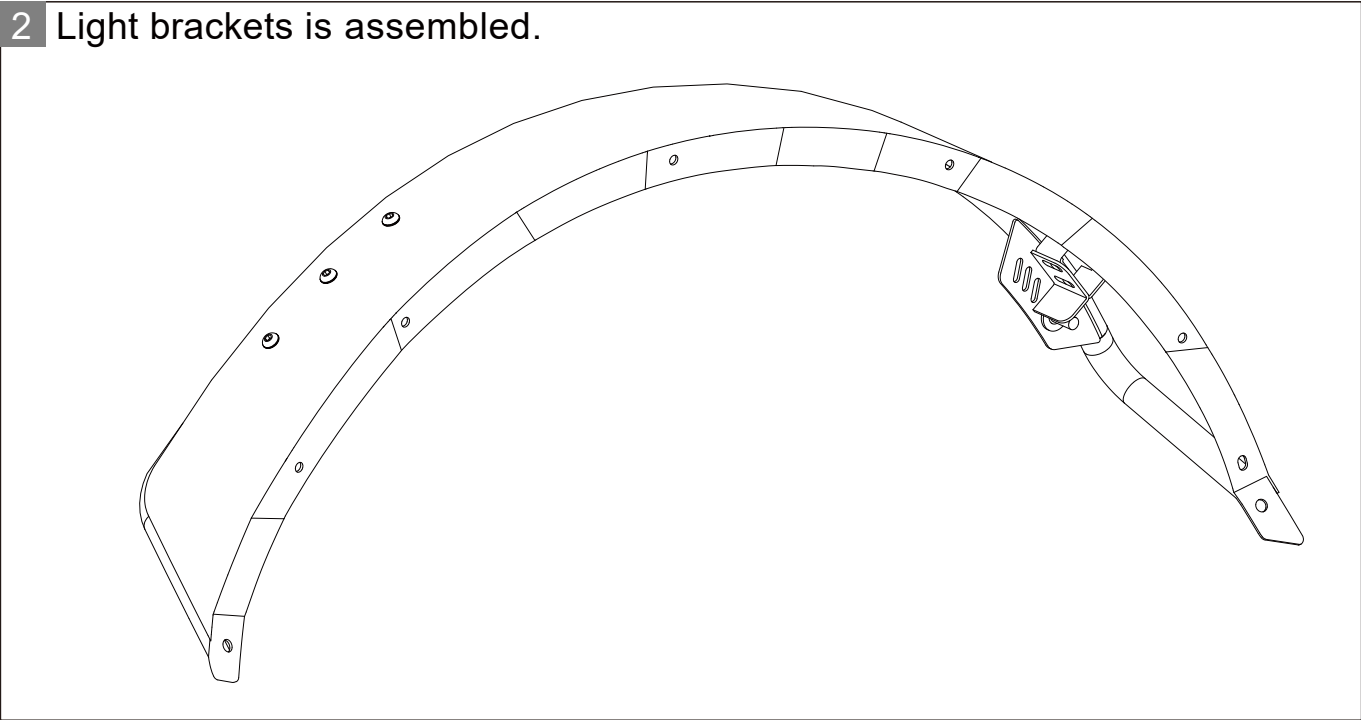
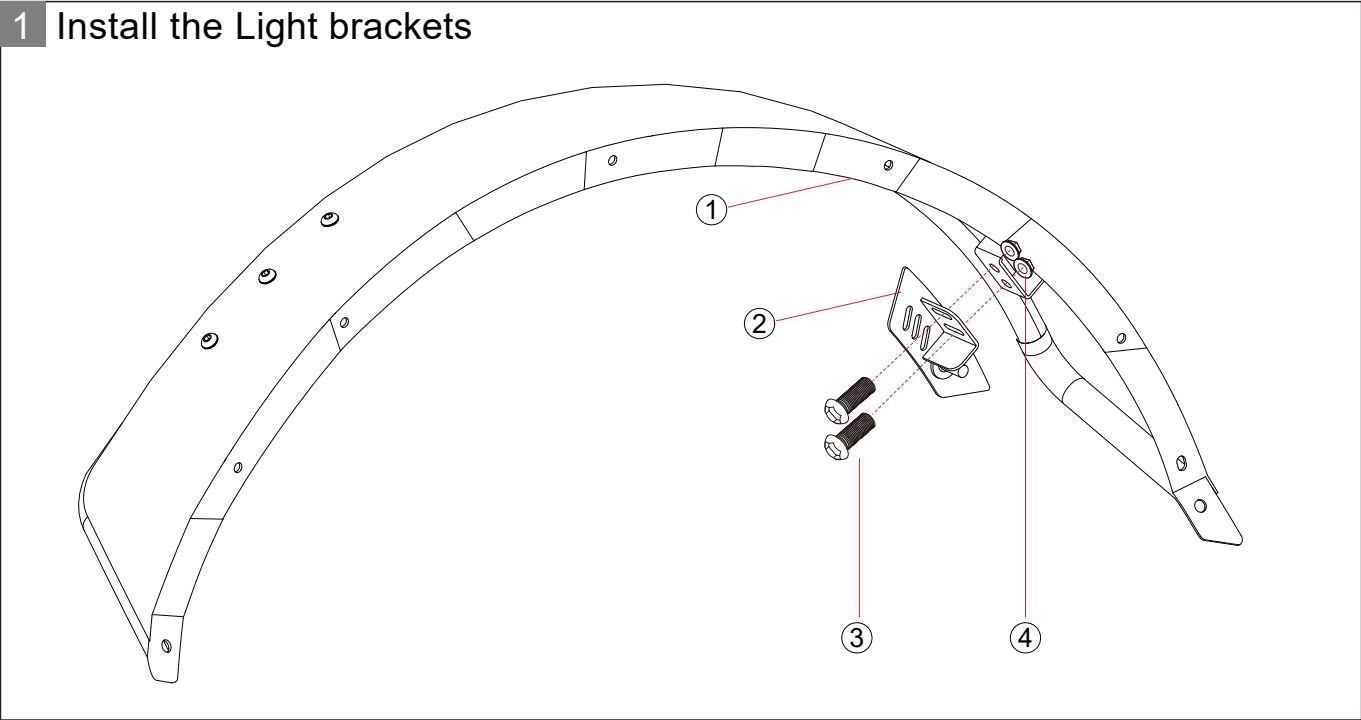
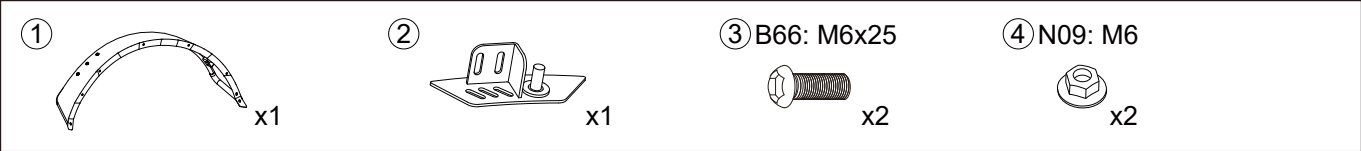

Repeat the steps **1** **2** for the other side.

Step 5: Install the Front Fender Flares.

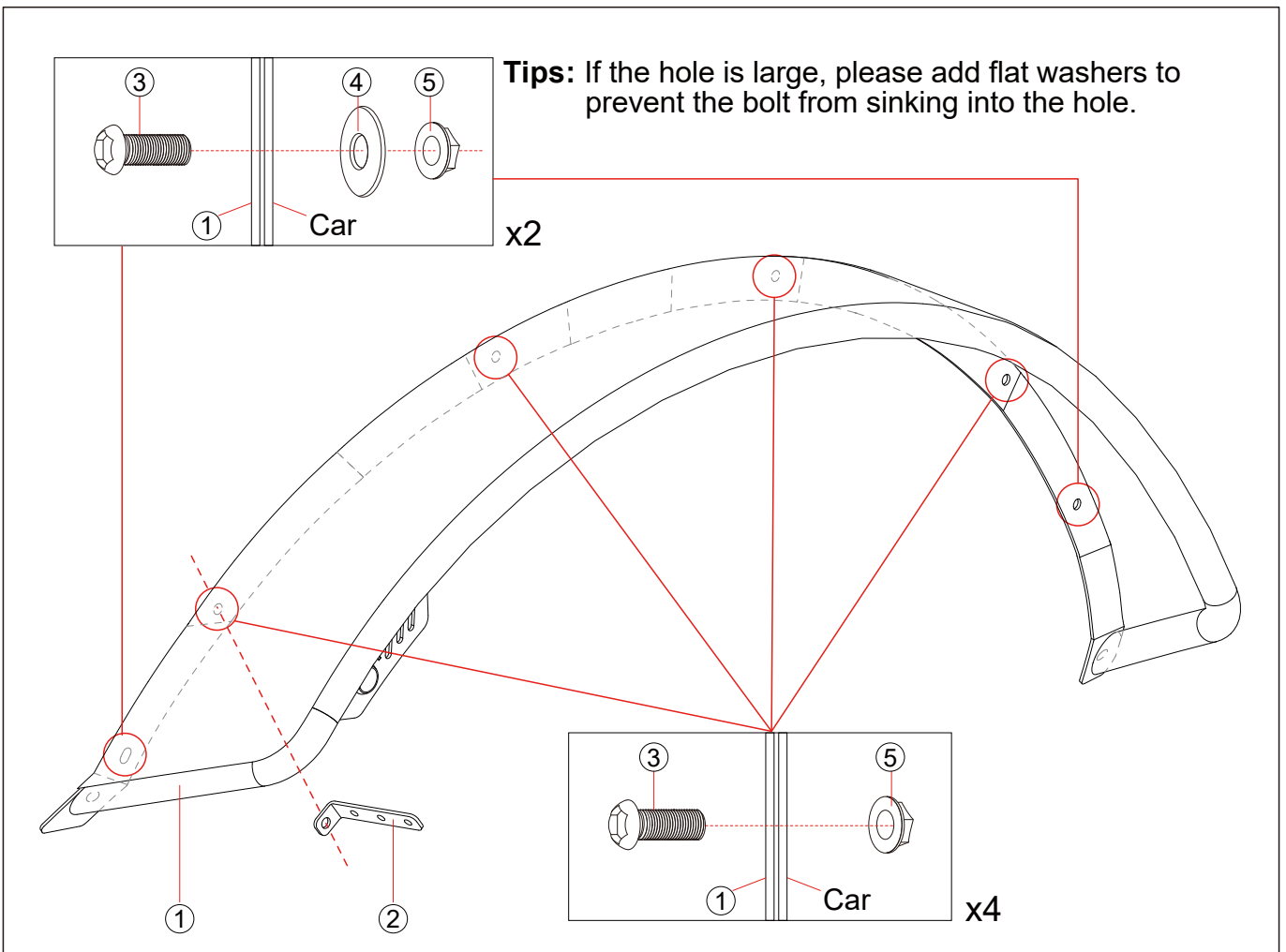
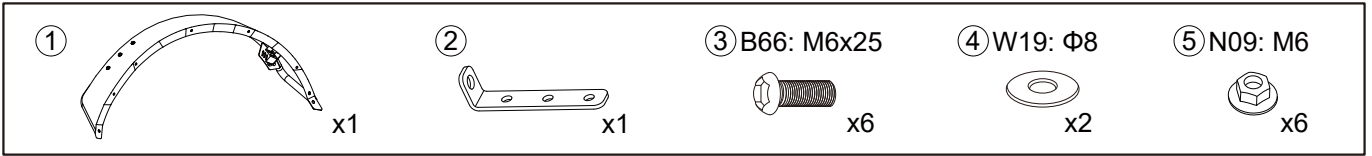

Repeat the above steps on the other side.

Step 6: Install the Rear Fender Flares.

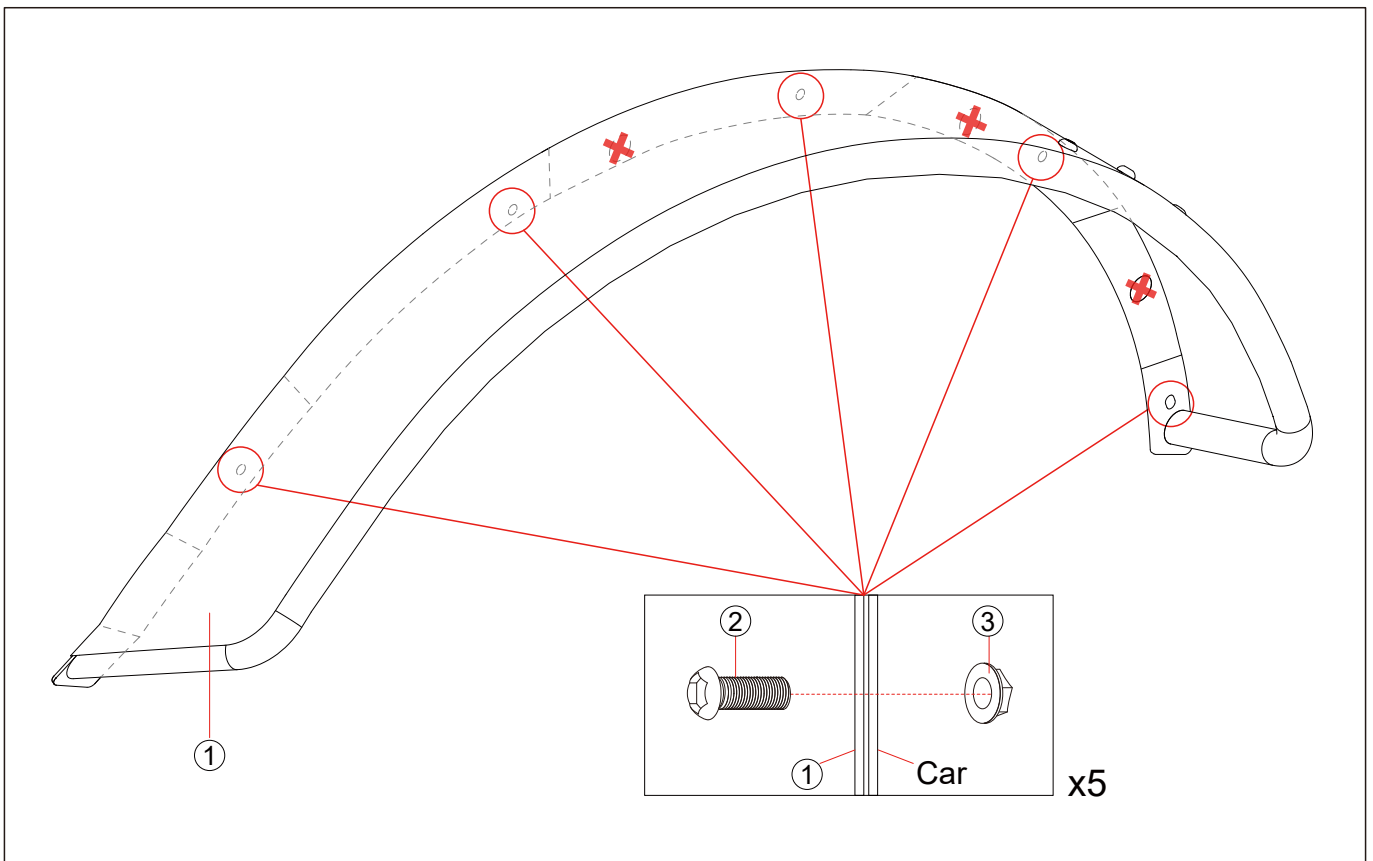
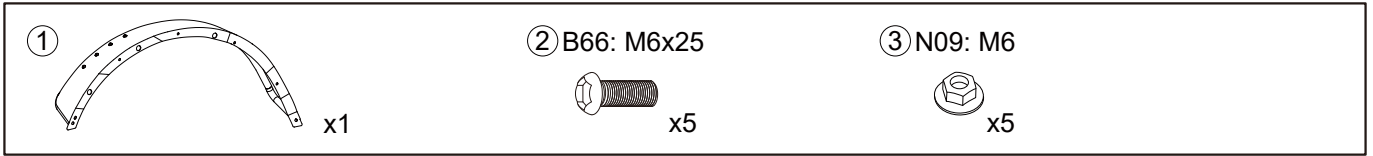

Repeat the above steps on the other side.

The Fender Flares is assembled.

