

# REAR BUMPER

————— User Manual —————

2021-2023 Ford Bronco(not Bronco Sport)

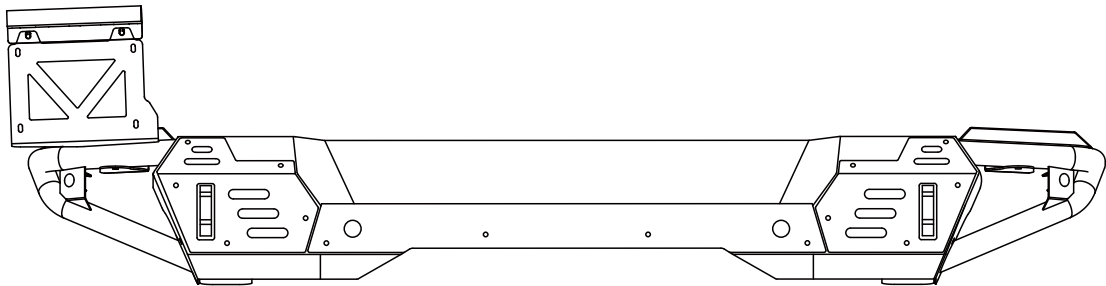

Model:	NFB01B105
Material:	Q235A
Product Dimensions:	69.6 x 12.3 x 17 inch
Package Dimensions:	55.5 x 15.7 x 11.4 inch
Product Weight:	67.2 lbs

---

※ Thank you for purchasing the REAR BUMPER. Please read this manual carefully and keep it properly if you need to refer to it afterward. If you need any support or assistance, please contact us with your product model number and order number, and our support team will help you solve problems.





**⚠ WARNING**

※ This product is designed primarily to enhance the appearance of the vehicle. Do not rely in any way on the components of this product to protect against injury or death in the event of an accident. To reduce the risk of serious injury or property damage, please read all safety messages and understand all instructions and procedure notices before attempting to install or use this product.



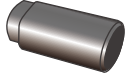

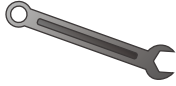
**⚠ CAUTION**





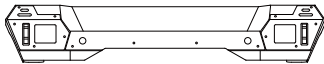
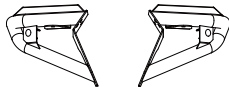
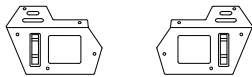
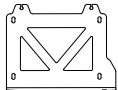
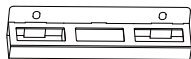
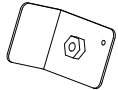

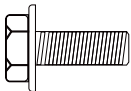
※ Properly torque and recheck fasteners and security of step tread after 250 miles and inspect frequently. Do not use if damaged.

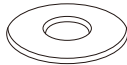
# REQUIRED TOOLS

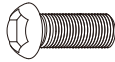
Socket 	Ratchet 	Wrench 	Allen Wrench 	Safety Glasses 
---	--	---	--	---

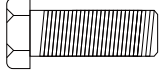
## Parts Information

NO.	Parts Name	Size	Line Graph	Qty	Color
/	Mid Bumper	/		1	Black
/	Side Wings	/		1	Black
/	decorative parts	/		1	Black
/	License brackets	/		1	Black
/	License brackets	/		1	Black
/	Nut Plates	/		2	Black
/	Plates	/		2	Black
B17	Hex Flange Bolts	M8x20		7	Dacro Black
N14	Hex Flange Nuts	M8		7	Dacro Black
W19	Flat Washer	Φ8x24x2		13	Dacro Black

B06	Half Head Allen Bolts	M6x15		5	Dacro Black
N09	Hex Flange Nuts	M6		5	Dacro Black
B37	Hex Bolts	M12x35		3	Dacro Black
W27	Flat Washer	Φ12x30x3		3	Dacro Black
W25	Spring Washer	Φ12		3	Dacro Black
B24	Half Head Allen Bolts	M6x40		5	Dacro Black
N11	Hex Lock Nuts	M6		5	Dacro Black

**Note:**

spare parts such as B17、 N14、 W19、 B06、 N09、 B37、 W27、 W25、 B24、 N11 are provided with 1PCS each (included in the number of parts details).

**Tips:**

This Front Bumber have two styles of decorative parts, you can choose one according to your personal preference.

① When you receive the bumper, it has installed one of the decorative parts.

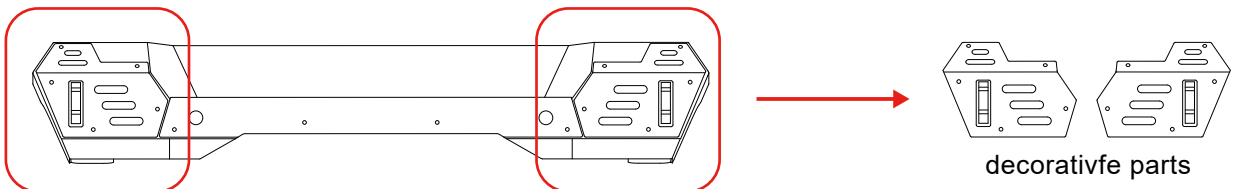

② If you like the onther decorative parts, please remove the decorative parts and bolts on the bumper and use the bolts to install it.

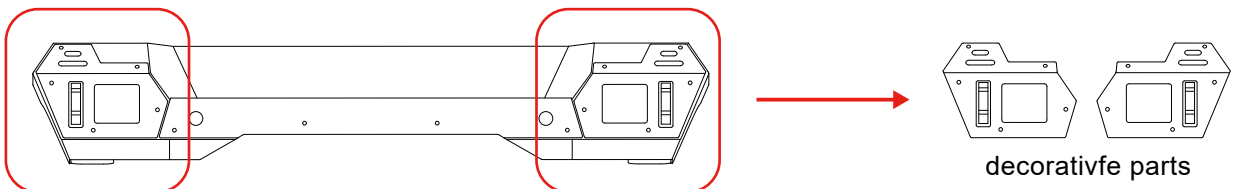

# Installation Instructions

**Step 1:** Open the carton and take out the parts. Check whether the number of components is complete.

**Step 2:** Remove the original bumper and prepare the parts needed to install the bumper.

**Step 3:** Splicing the Bumper.

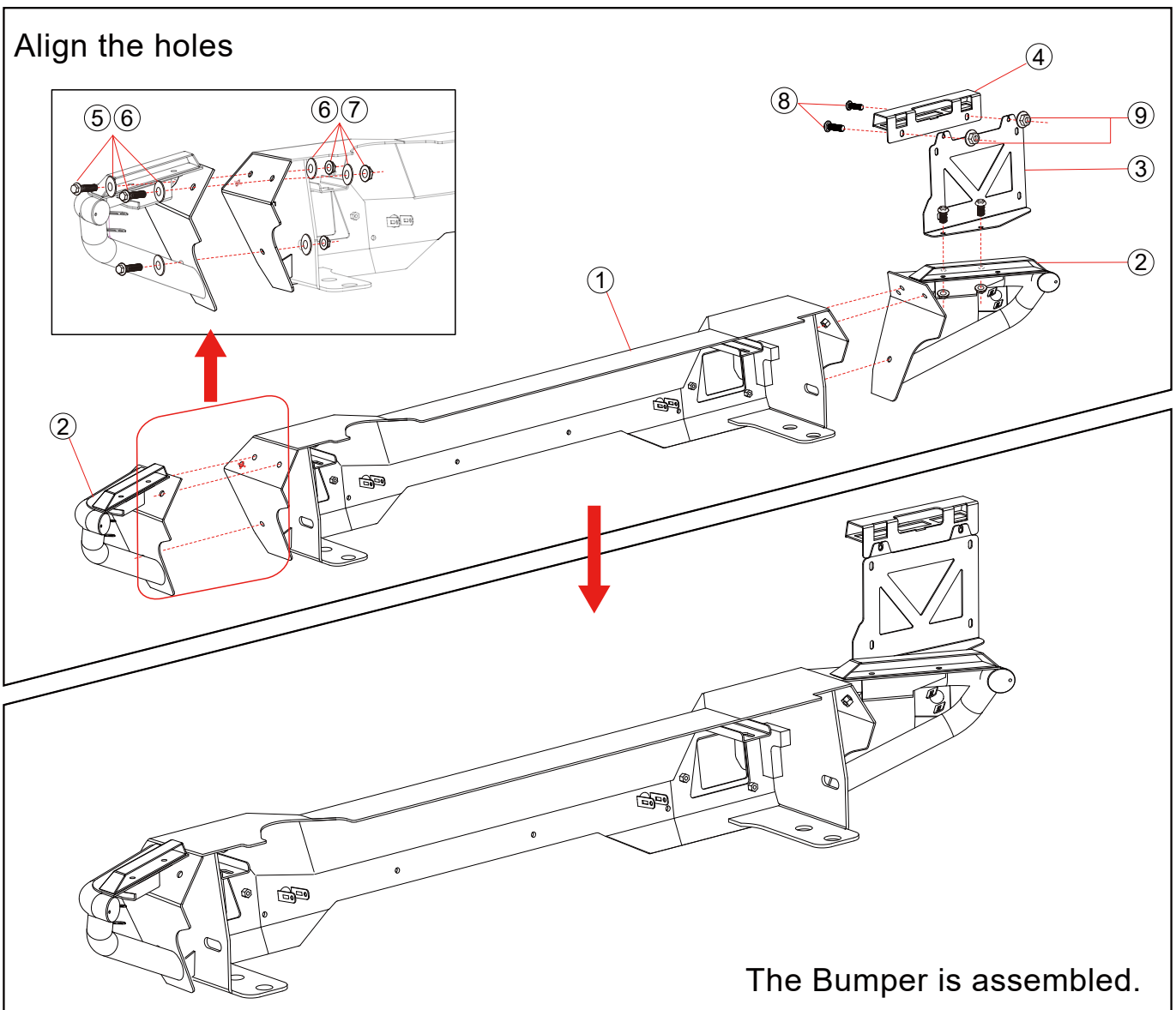
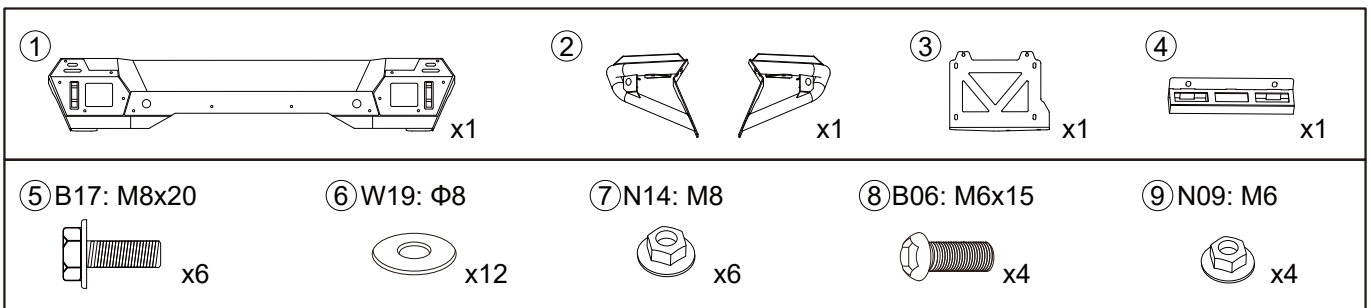

### Step 4: Install the Radar Probe.

**Note:** If the car does not have a radar probe, this step can be ignored.

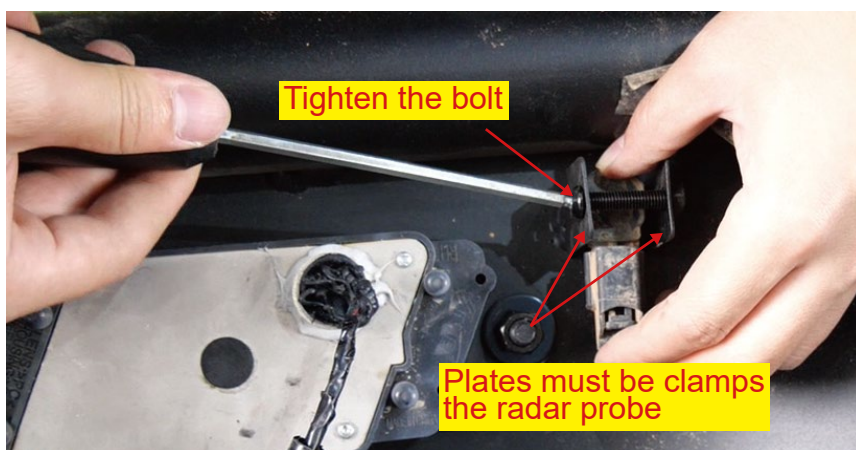
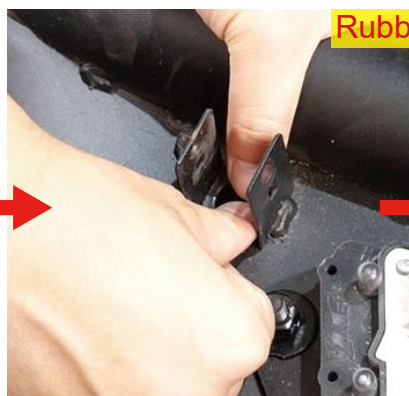
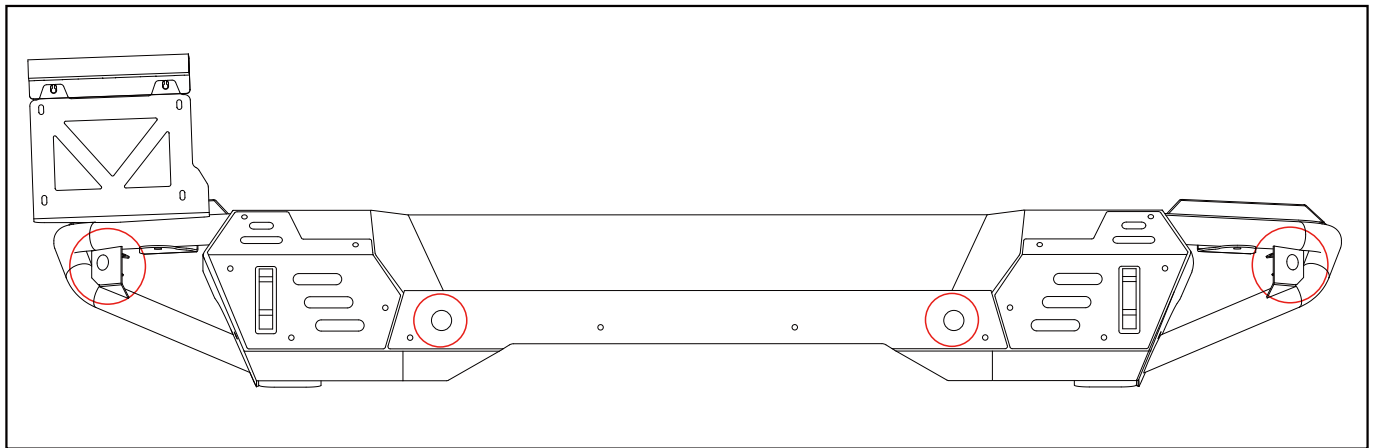

**Step 5:** Install the bumper and tighten the bolts.

