

FRONT BUMPER

————— User Manual —————

2021-2023 Ford Bronco (Not Bronco Sport)



Model:	NFB01A101
Material:	Q235A
Product Dimensions:	64.6 x 16.3 x 8.7 inch
Package Dimensions:	68.1 x 18.5 x 10.6 inch
Product Weight:	88 lbs

※ Thank you for purchasing the FRONT BUMPER. Please read this manual carefully and keep it properly if you need to refer to it afterward. If you need any support or assistance, please contact us with your product model number and order number, and our support team will help you solve problems.





⚠ WARNING

※ This product is designed primarily to enhance the appearance of the vehicle. Do not rely in any way on the components of this product to protect against injury or death in the event of an accident. To reduce the risk of serious injury or property damage, please read all safety messages and understand all instructions and procedure notices before attempting to install or use this product.





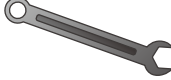

⚠ CAUTION

※ Properly torque and recheck fasteners and security of step tread after 250 miles and inspect frequently. Do not use if damaged.

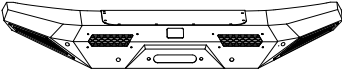
REQUIRED TOOLS

Socket 	Ratchet 	Wrench 	Safety Glasses 
---	--	--	---

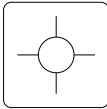
Parts Information

	NO.	Parts Name	Size	Line Graph	Qty	Color
①	/	Bumper	/		1	Black
②	/	4 Inch Ledlight	/		2	Black
③	B46	Half Head Allen Bolts	M6x40		6	Dacro Black
④	W27	Flat Washe	Φ12x30x3		2	Dacro Black
⑤	W25	Spring Washer	Φ12		2	Dacro Black
⑤	N19	Hex Nuts	Φ12		2	Dacro Black
⑥	W40	Plastic Plate	Φ12		2	PVC
⑦	M01	Ribbon	5x250		10	Black

※ Note: spare parts such as B46、W27、W25、N19 and W40 are provided with 1PCS each (included in the number of parts details).

Installation Instructions

Step 1: Open the carton and take out the parts. Check whether the number of components is complete.

Step 2: Remove the original bumper and prepare the parts needed to install the bumper.

Step 3: Remove the skid plate and winch plate on the new bumper.

Note: take care the parts needed to install on the skid plate and winch plate later.

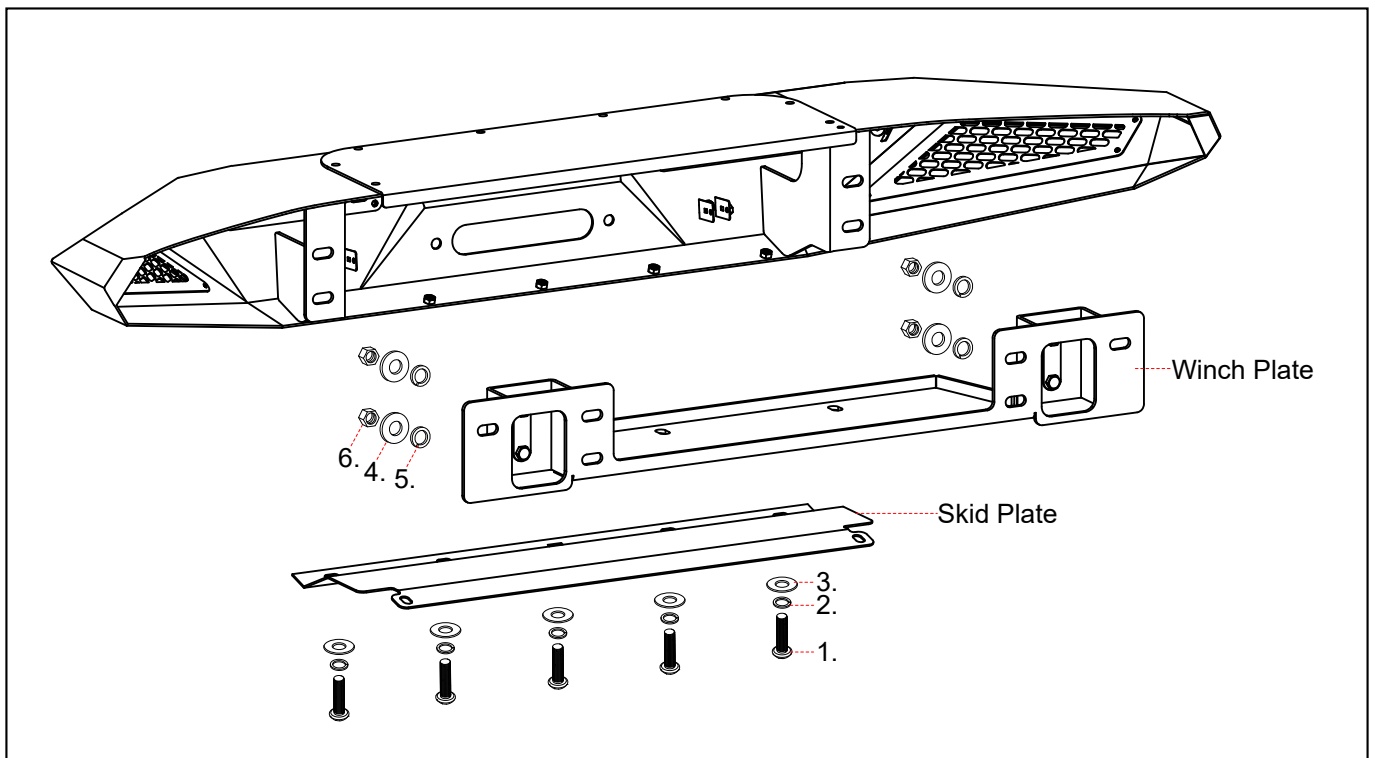
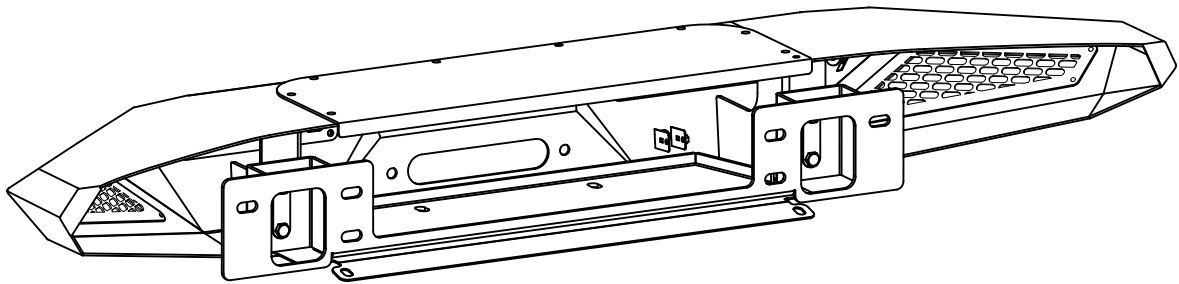

	NO.	Parts Name	Size	Qty		NO.	Parts Name	Size	Qty
1.	B08	Half Head Allen Bolts	M6x20	5	4.	W27	Flat Washe	Φ12x30x3	4
2.	W08	Spring Washer	Φ6	5	5.	W25	Spring Washer	Φ12	4
3.	W12	Flat Washer	Φ6x16x1	5	6.	N19	Hex Nuts	M12	4

Step 4: Install the Radar Probe.

Note: If the car does not have a radar probe, this step can be ignored.

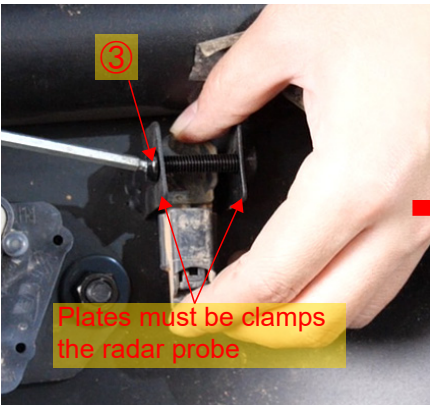
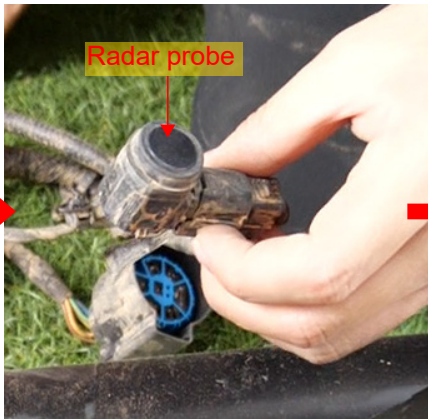
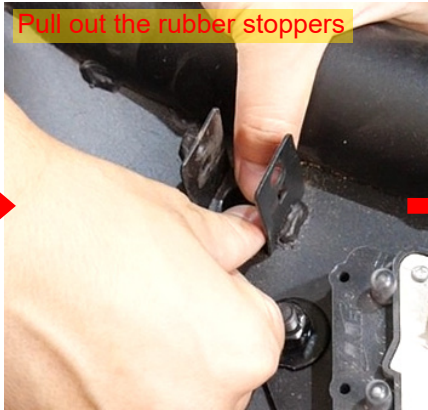
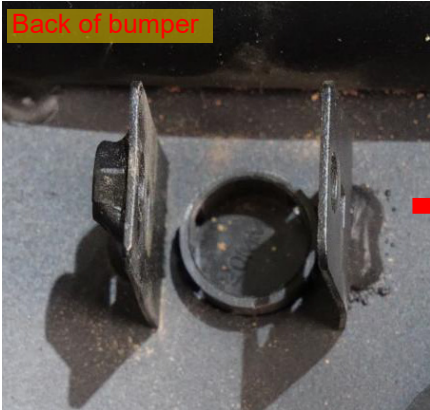

Step 5: Install the 4 Inch Ledlight.

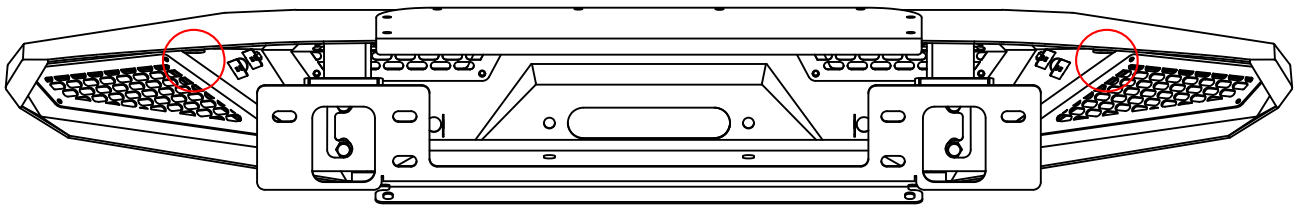
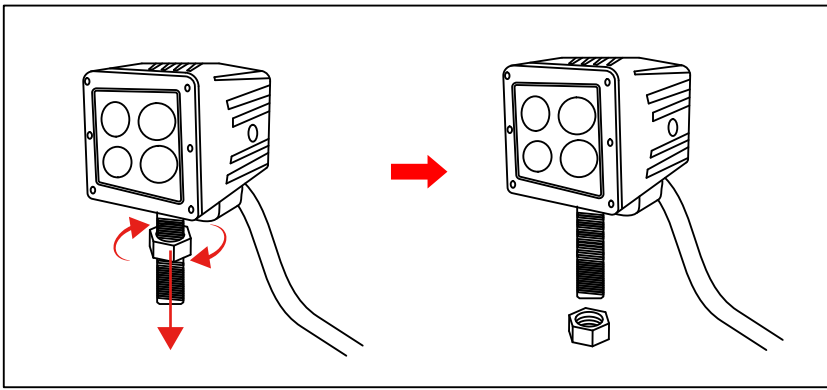

Step 5: Install the Winch Plate in the car.

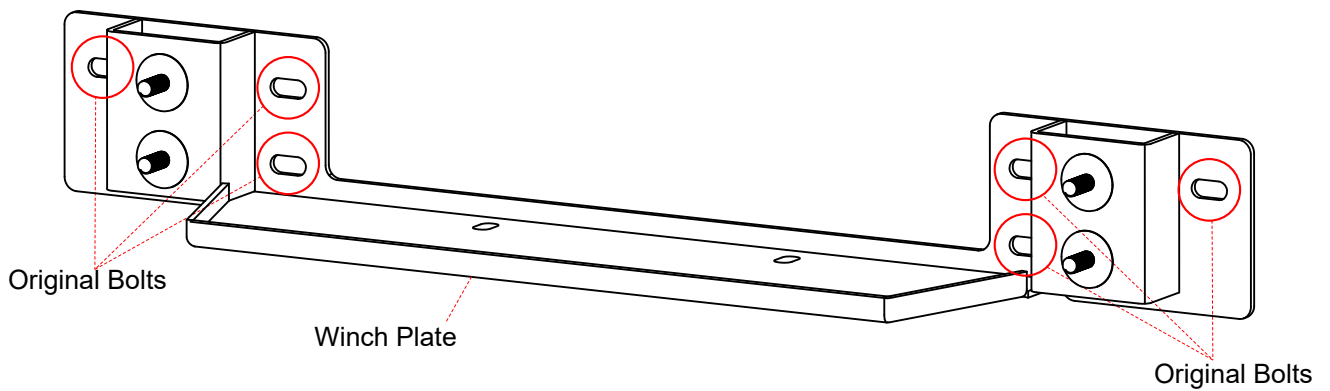

Step 6: Install the Bumper.

Please install bolts than remove from step 3. (Parts: 4. 5. 6.)

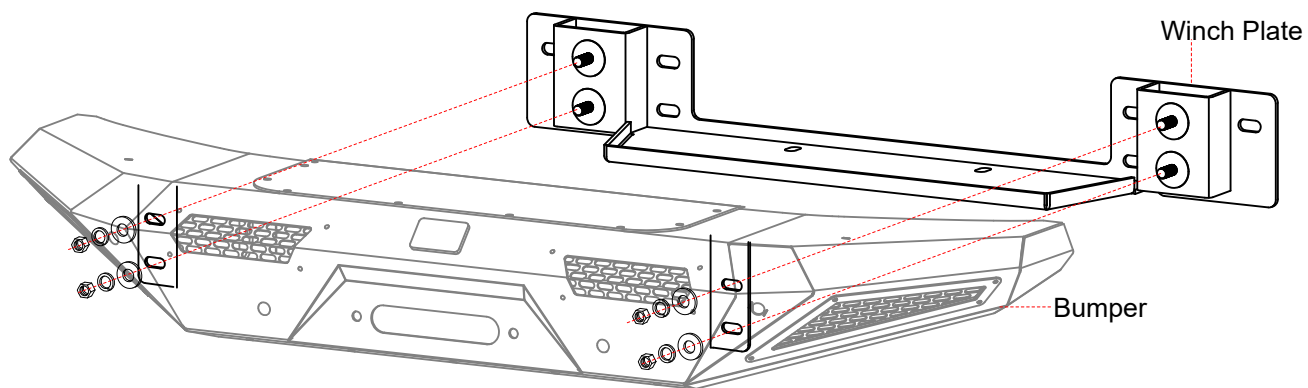

Step 7: Install the Skid Plate.

Please install bolts than remove from step 3 (Parts: 1. 2. 3.) and original bolts.

