

# REAR BUMPER

————— User Manual —————

2021-2023 Ford F-150(Exclude Raptor)



NF103B102

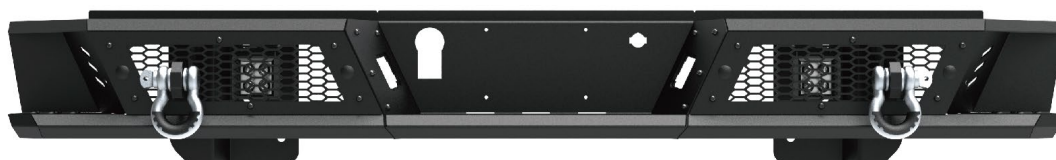

NF103B103

Model:	NF103B102	NF103B103
Material:	Q235A	Q235A
Product Dimensions:	75.1 x 12.1 x 8.9 inch	74.5 x 12 x 9 inch
Package Dimensions:	31.9 x 26.8 x 12.6 inch	31.9 x 26.8 x 12.6 inch
Product Weight:	88.2 lbs	81.6 lbs

---

※ Thank you for purchasing the REAR BUMPER. Please read this manual carefully and keep it properly if you need to refer to it afterward. If you need any support or assistance, please contact us with your product model number and order number, and our support team will help you solve problems.





**⚠ WARNING**

※ This product is designed primarily to enhance the appearance of the vehicle. Do not rely in any way on the components of this product to protect against injury or death in the event of an accident. To reduce the risk of serious injury or property damage, please read all safety messages and understand all instructions and procedure notices before attempting to install or use this product.





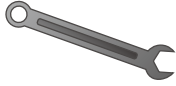

**⚠ CAUTION**





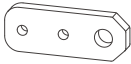
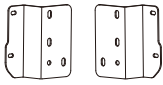

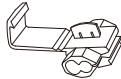



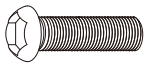

※ Properly torque and recheck fasteners and security of step tread after 250 miles and inspect frequently. Do not use if damaged.

# REQUIRED TOOLS

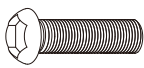
Socket 	Ratchet 	Wrench 	Allen Wrench 	Safety Glasses 
---	--	---	--	---

## Parts Information

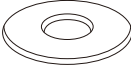
NO.		Parts Name	Size	Line Graph	Qty	Color
①	/	Mid Bumper	/		1	Black
②	102	Side Wings	/	 or 	1	Black
	103		/			
③	/	Trailer Hitch	/		2	Black
④	/	Brackets	/		1	Black
⑤	/	Led lights	4inch		2	/
⑥	/	Cable Wires	2x0.75mm		2	/
⑦	/	Wire Connector Clips	/		8	/
⑧	/	Shackles	/		2	/
⑨	/	Zip ties	/		10	/

NO.		Parts Name	Size	Line Graph	Qty	Color
⑩	B35	Hex Bolts	M10x35		5	Dacro Black
⑪	W22	Spring Washer	Φ10		5	Dacro Black
⑫	W23	Flat Washer	Φ10x25x2		9	Dacro Black
⑬	N15	Hex Nuts	M10		5	Dacro Black
⑭	B15	Half Head Allen Bolts	M8x20		9	Dacro Black
⑮	N14	Hex Flange Nuts	M8		9	Dacro Black
⑯	B74	Half Head Allen Bolts	M6x35		7	Dacro Black
⑰	N11	Hex Lock Nuts	M6		7	Dacro Black
⑱	B75	Hex Bolts	M12x45		11	Blue Zinc Plating
⑲	W29	Spring Washer	Φ12		11	Blue Zinc Plating
⑳	W28	Flat Washer	Φ12x30x3		17	Blue Zinc Plating
㉑	N24	Hex Nuts	M12		11	Blue Zinc Plating

**NOTE:**

Spare parts such as B35、 W22、 W23、 N15、 B15、 N14、 B74、 N11、 B75、 W29、 W28 and N24 are provided with 1PCS each (included in the number of parts details).

# Installation Instructions

**Step 1:** Open the carton and take out the parts. Check whether the number of components is complete.

**Step 2:** Locate the rear bumper harness and disconnect the large plug. **(Figure 1)**

**Step 3:** Disconnect the trailer connections from the inside of the bumper around the license plate area. **(Figure 2)**

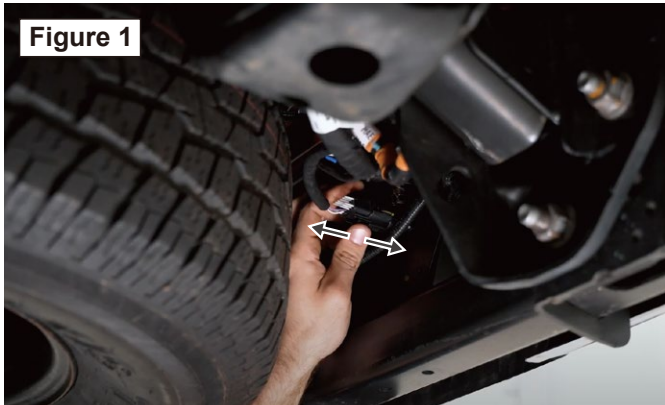

**Step 4:** Support the bumper and remove the three nuts from the Driver and Passenger side. **(Figure 3~4)**

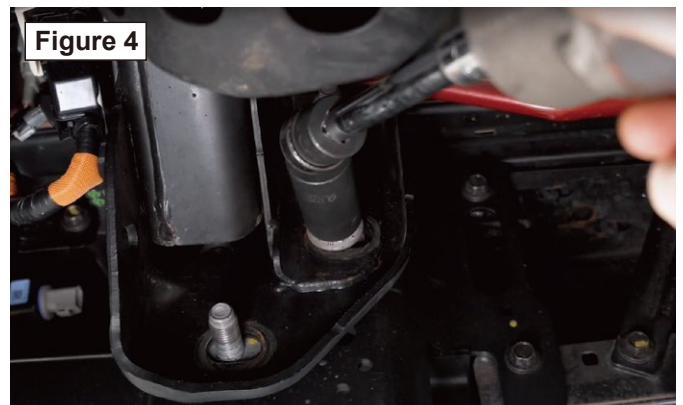
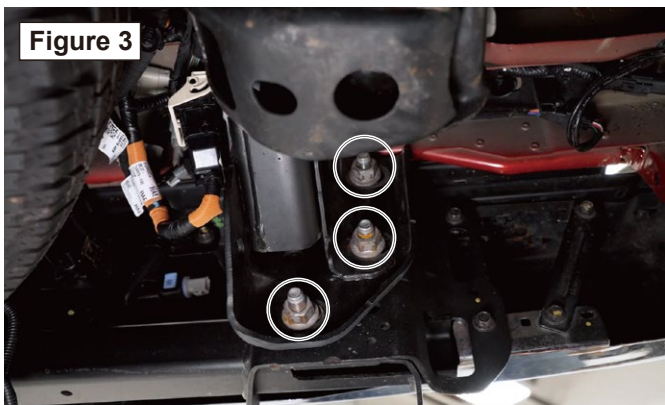

**Step 5:** Remove the bumper from the vehicle. **(Figure 5)**

**Step 6:** Disconnect the sensors from the wiring harness. Then remove the sensors from the bumper mount. **(Figure 6)**





**Step 7:** Disconnect the license plate light harness and remove the light mount from the bumper. **(Figure 7)**

**Step 8:** Using a pry tool remove the wiring harness clips from the bumper. Then remove the wiring harness from the bumper. **(Figure 8)**



**Step 9:** Compress the locking tabs on the trailer light plug and remove from the bumper. **(Figure 9)**

**Step 10:** Using the ignition key remove the spare tire lock from the bumper. **(Figure 10)**

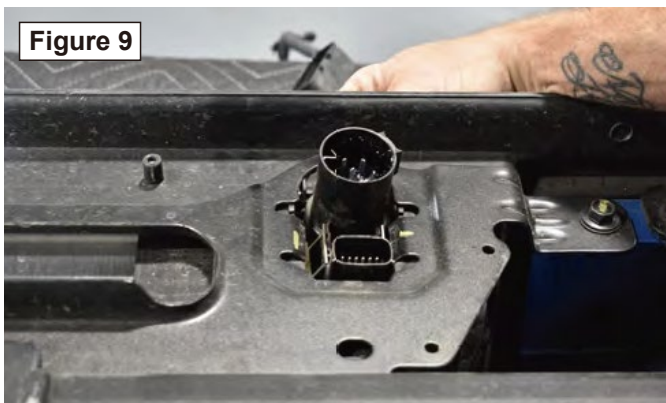



## Step 12: Install the Trailer Hitch.

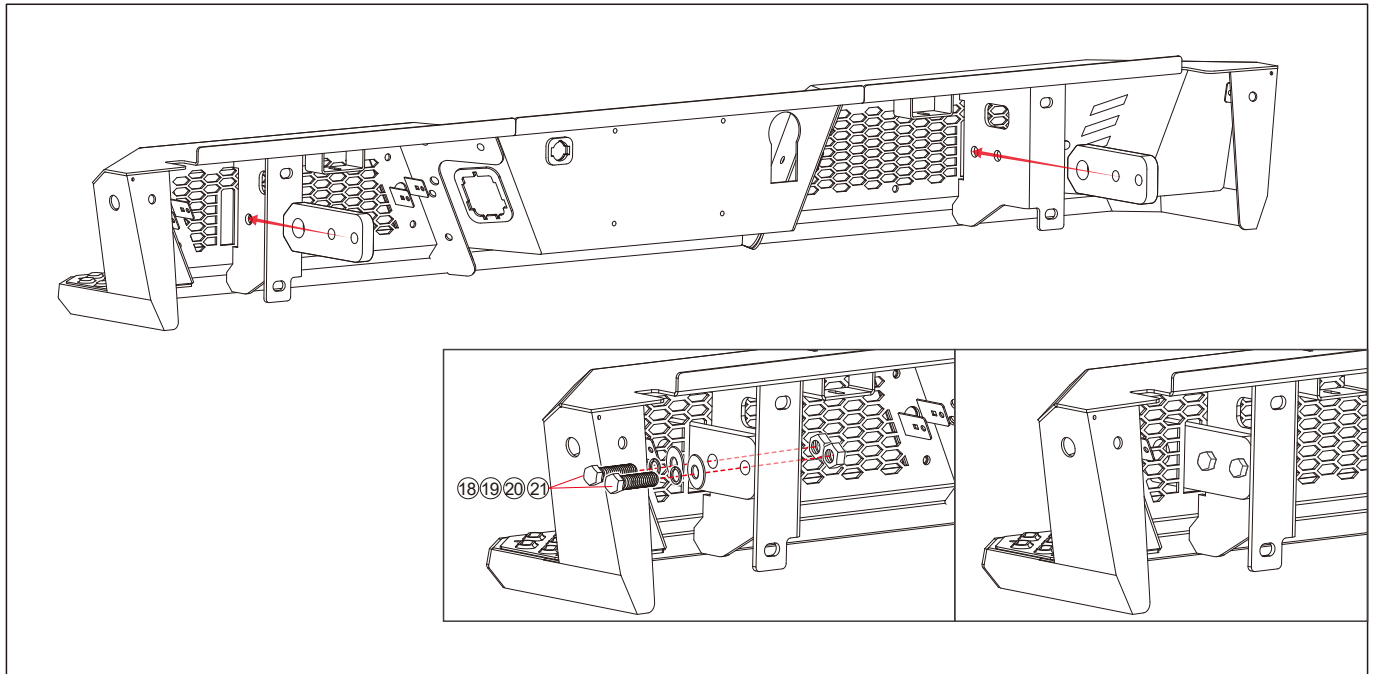
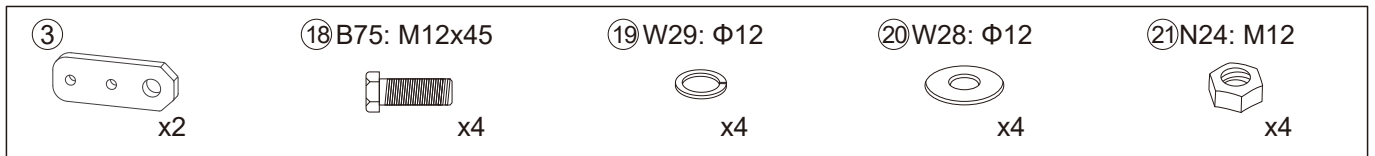

## Step 13: Install the Shackles.

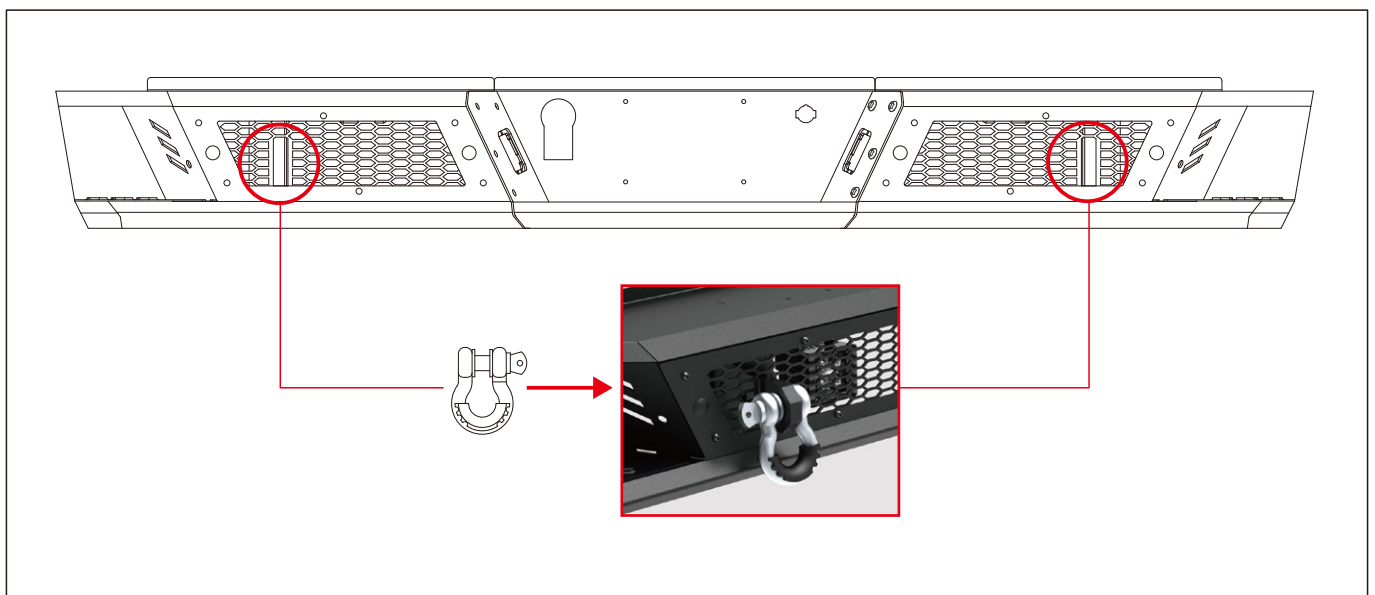



**Step 14: Install the 4 Inch Led lights.**

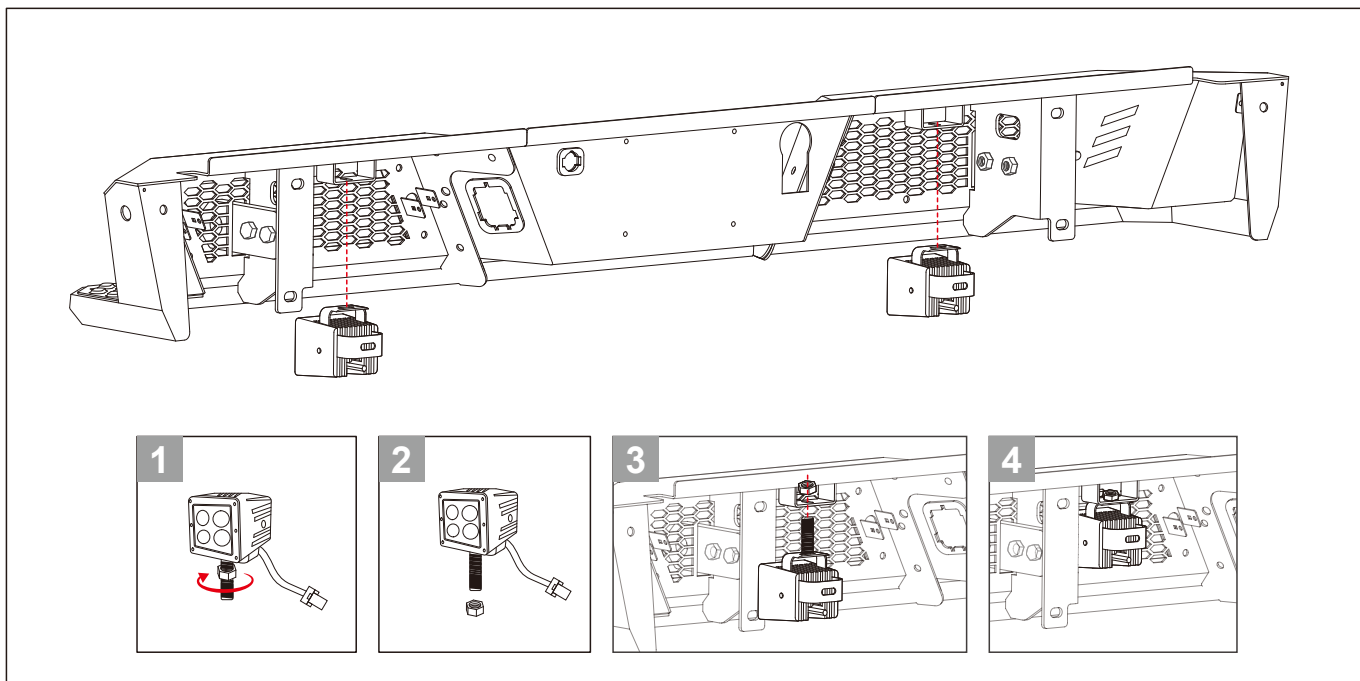

**Step 15: Install the license plate light. Seat the clips when installed. (Figure 11-12)**

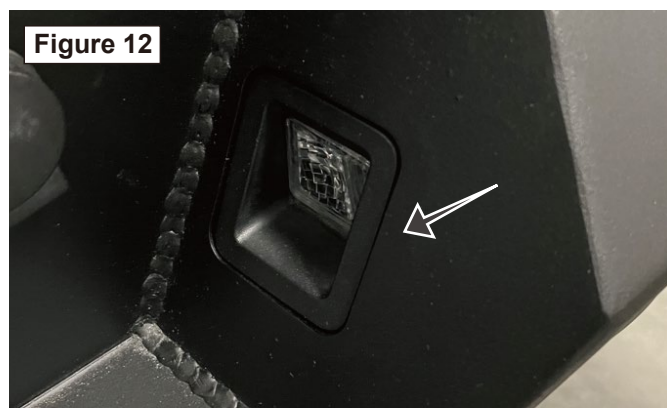

**Step 16: Install the spare tire lock. (Figure 13-14)**



**Step 17:** Install the original 7-way trailer plug wiring harness. (Figure 15-16)



**Step 18:** Connect the Trailer plug wiring, 4inch Led lights and ⑥ Cabel wires.

**7-Way Connector Wiring/Function Diagram**

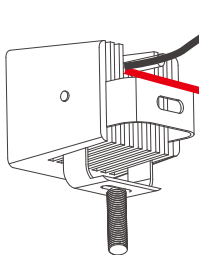
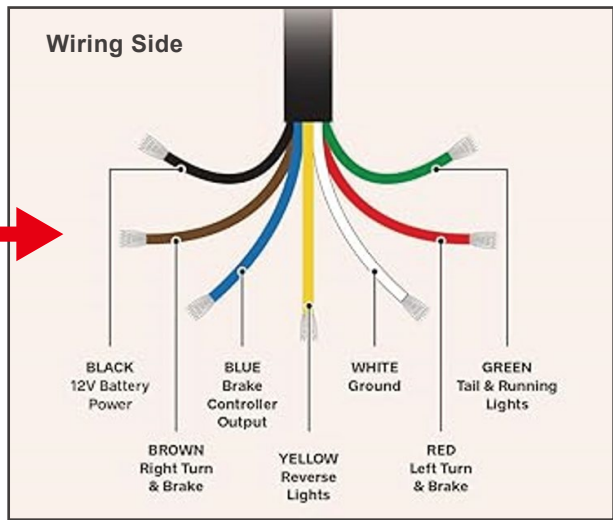
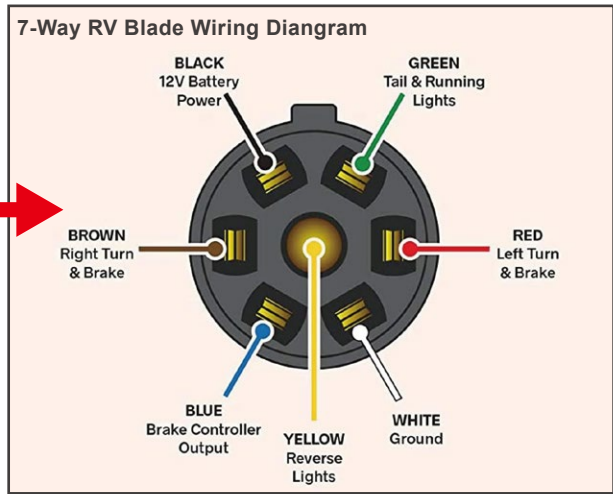

4inch Led light

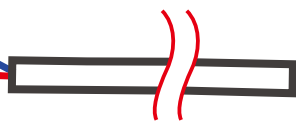

Cabel wire

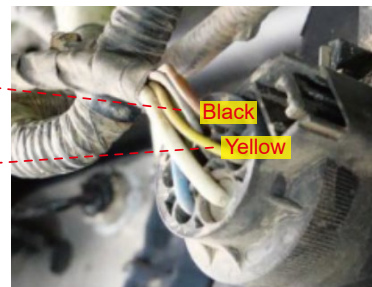

Trailer plug wiring



## Step 19: Install the Radar Probe.

**Note:** If the car does not have a radar probe, this step can be ignored.

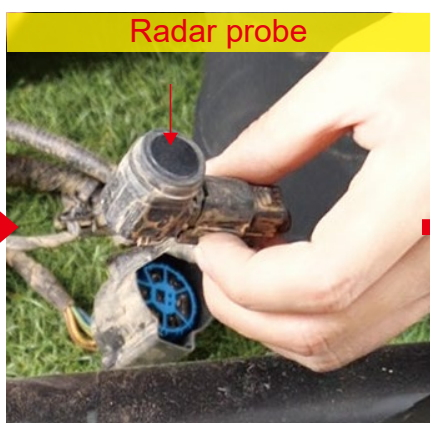
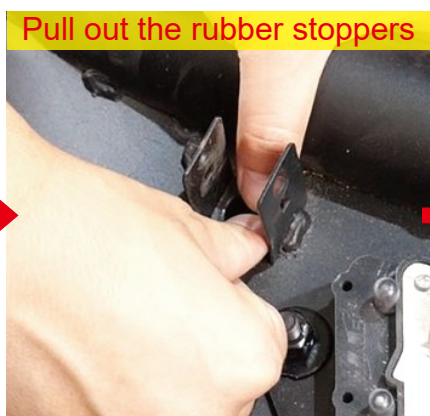
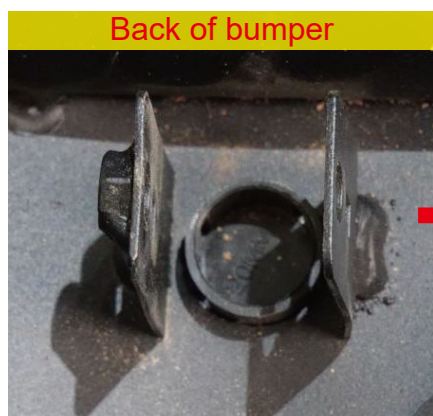
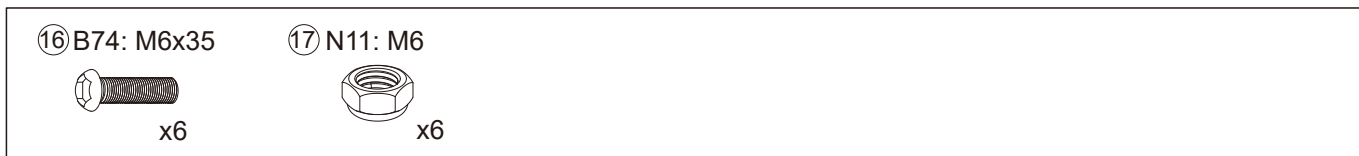

## Step 20: Install the Rear Bumper.

 <p>④ x1</p>	 <p>⑩ B35: M10x35 x4</p>	 <p>⑪ W22: Φ10 x4</p>	 <p>⑫ W23: Φ10 x8</p>	 <p>⑬ N15: M10 x4</p>
 <p>⑱ B75: M12x45 x6</p>	 <p>⑲ W29: Φ12 x6</p>	 <p>⑳ W28: Φ12 x12</p>	 <p>㉑ N24: M12 x6</p>	

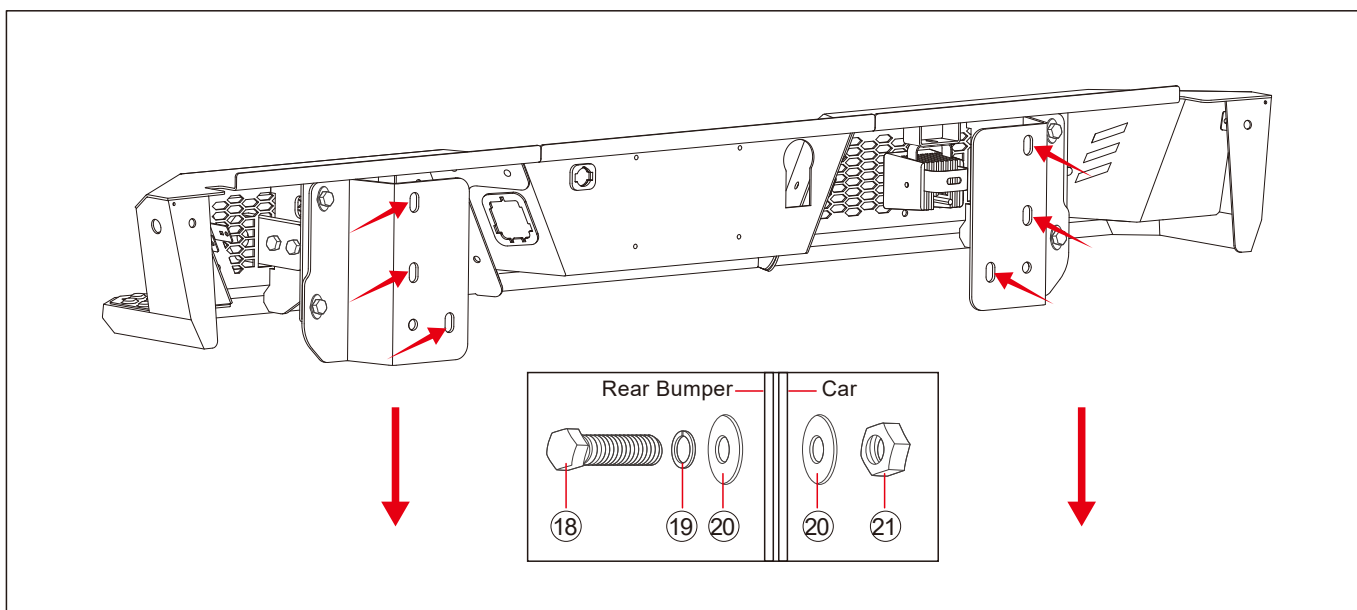
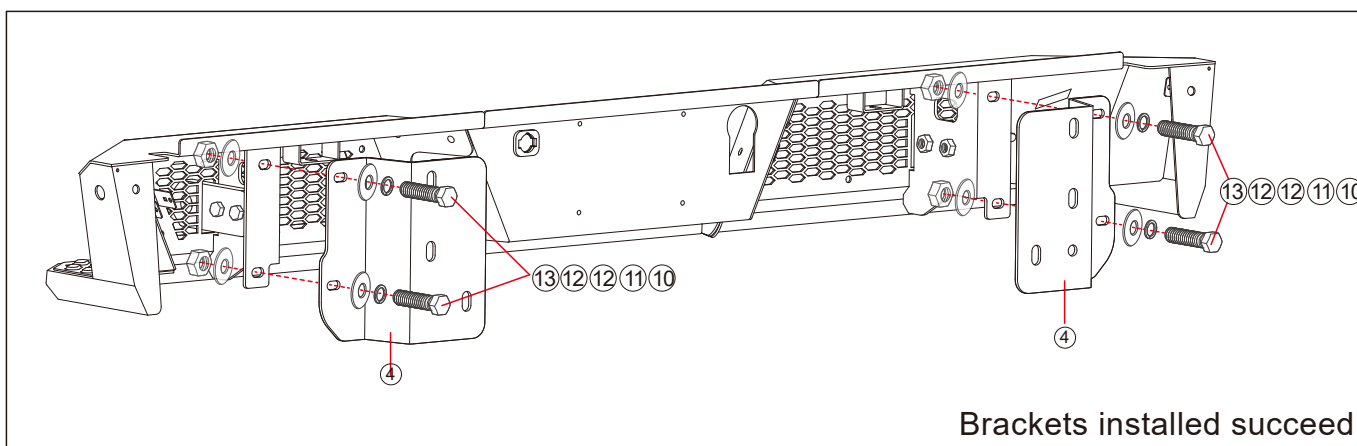



**Step 21:** The rear bumper is installed.

