

REAR BUMPER

— User Manual —

2015-2020 F-150 Excluding Raptor



Model:	NF101B102 / NF101B103
Material:	Q235A
Product Dimensions:	74.5 x 11 x 10.8 inch
Package Dimensions:	31.8 x 26.7 x 12.6 inch
Product Weight:	80.4 lbs / 66.1 lbs

※ Thank you for purchasing the REAR BUMPER. Please read this manual carefully and keep it properly if you need to refer to it afterward. If you need any support or assistance, please contact us with your product model number and order number, and our support team will help you solve problems.









⚠ WARNING

※ This product is designed primarily to enhance the appearance of the vehicle. Do not rely in any way on the components of this product to protect against injury or death in the event of an accident. To reduce the risk of serious injury or property damage, please read all safety messages and understand all instructions and procedure notices before attempting to install or use this product.

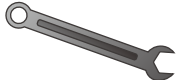

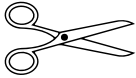

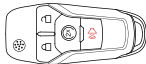



⚠ CAUTION

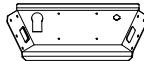
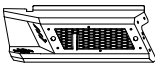
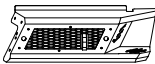
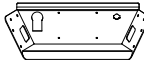
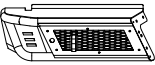
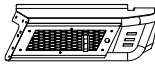







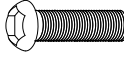

※ Properly torque and recheck fasteners and security of step tread after 250 miles and inspect frequently. Do not use if damaged.

REQUIRED TOOLS

Socket 	Ratchet 	Wrench 	Allen Wrench 	Safety Glasses 
Scissors 	Masking tape 	Wrench 	Plastic trim tool 	

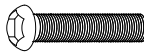
Parts Information

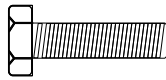
NO.	Parts Name	Size	Line Graph	Qty	Color
102	Mid Bumper & Side Wings	/	   or   	1	Black
103					
/	Brackets	/	 	1	Black
/	Trailer Hitch	/		2	Black
/	Led lights	4inch		2	Black
/	Cable Wires	0.75x1.2m		2	Black
/	Wire Connector Clips	/		8	/
/	Shackles	/		2	/
/	Zip ties	5x250		10	/

NO.	Parts Name	Size	Line Graph	Qty	Color
W22	Spring Washer	Φ10		5	Dacro Black
W23	Flat Washer	Φ10		9	Dacro Black
B35	Half Head Allen Bolts	M10x35		5	Dacro Black
N15	Hex Nuts	M10		5	Dacro Black
B15	Half Head Allen Bolts	M8x20		9	Dacro Black
N14	Hex Flange Nuts	M8		9	Dacro Black
B74	Half Head Allen Bolts	M6x35		5	Dacro Black
N11	Hexagon Lock Nut	M6		5	Dacro Black
N24	Hex Nuts	M12		11	Blue Zinc Plating
B75	Hex Bolts	M12x45		11	Blue Zinc Plating
W29	Spring Washer	Φ12		11	Blue Zinc Plating
W28	Flat Washer	Φ12		17	Dacro Black

※ **Note:** spare parts such as W22、W23、B35、N15、B15、N14、B74、N11、N24、B75、W29 and W28 are provided with 1PCS each (included in the number of parts details).









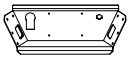

Installation Instructions

※ **Note:** This installation manual takes one of the models as an example.

Step 1: Open the carton and take out the parts. Check whether the number of components is complete.

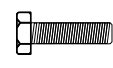
Step 2: Remove the original bumper and prepare the parts needed to install the bumper.

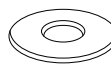
Step 3: Splicing the rear bumper and tighten the bolts.

① Bumper  x1	② Side Wings(L & R)  x1	③  x2	④  x2	⑤ B15: M8x20  x8	
⑥ N14: M8  x8	⑦ N24: M12  x4	⑧ B75: M12x45  x4	⑨ W29: Φ 12  x4	⑩ W28: Φ 12  x4	⑪  x2

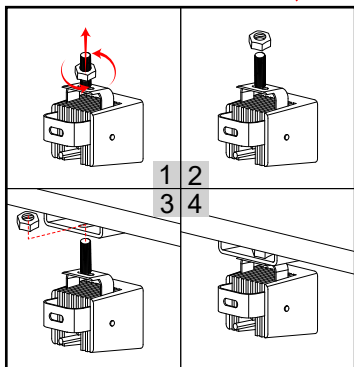
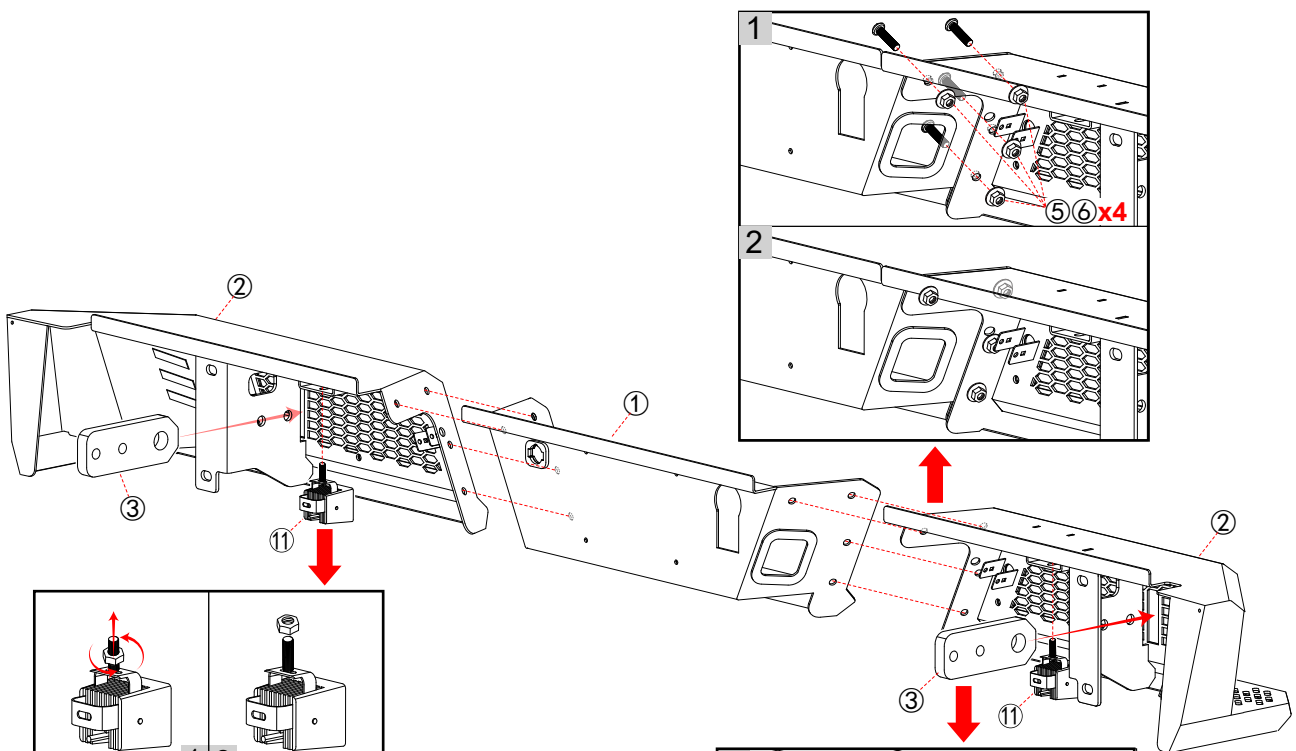

Install the 4inch Led Lights(2pcs)

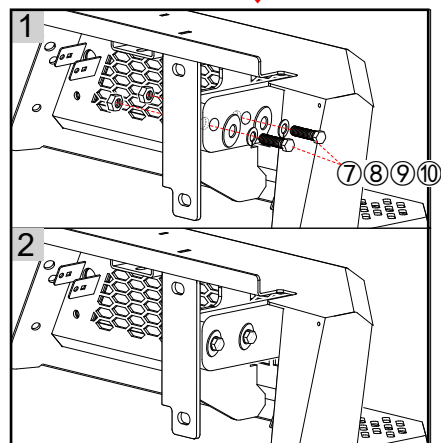

Install the Trailer Hitches(2pcs)

Install the Shackles(2pcs)

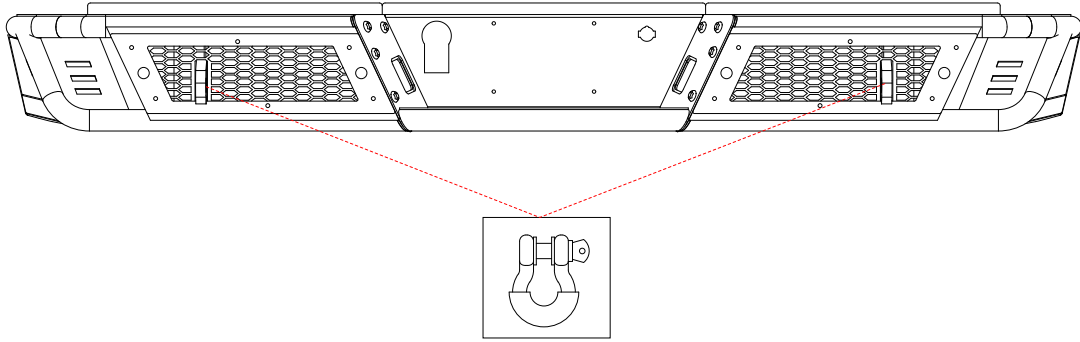

The bumper is assembled.

NF101B102

Front



Back



NF101B103

Front



Back



Step 4: Install the Radar Probe.

Note: If the car does not have a radar probe, this step can be ignored.

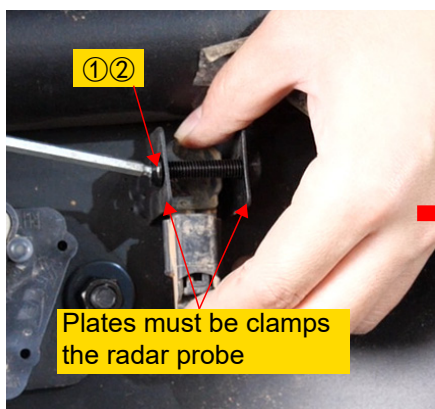
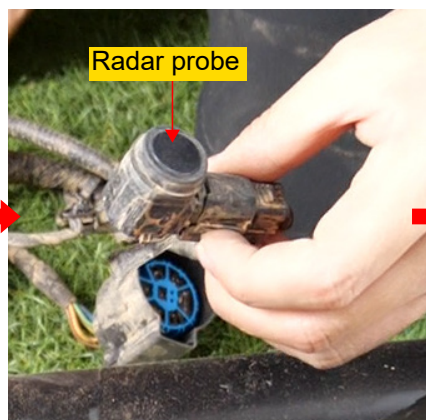
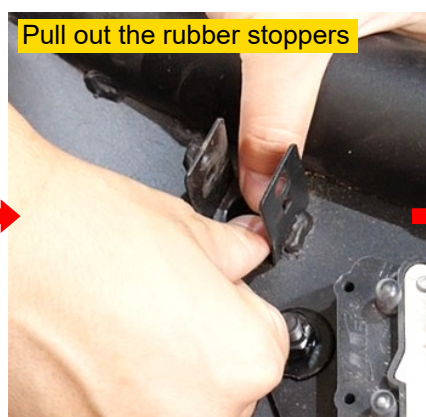
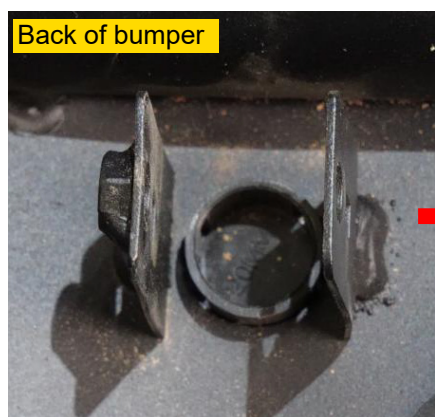
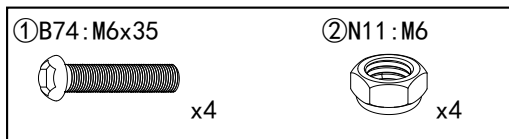

Step 5: Install the original spare tire lock, original 7-way trailer plug wiring harness and original license Light.

1. Install the original spare tire lock.



2. Install the original 7-way trailer plug wiring harness.

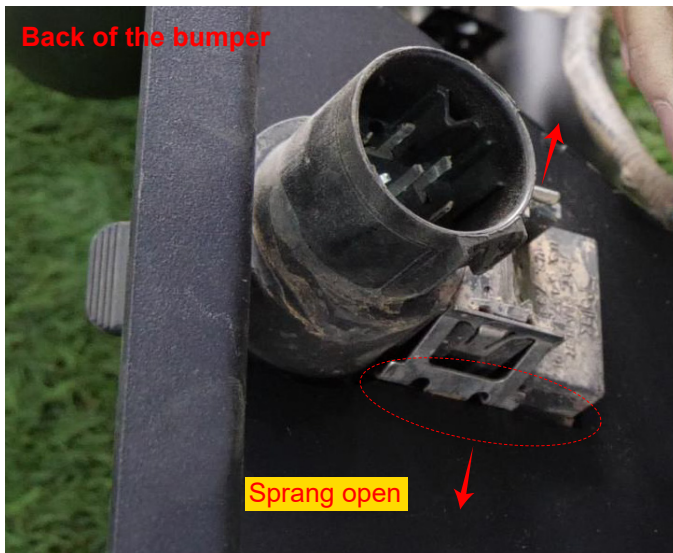

3. Install the original license Lights(2pcs).

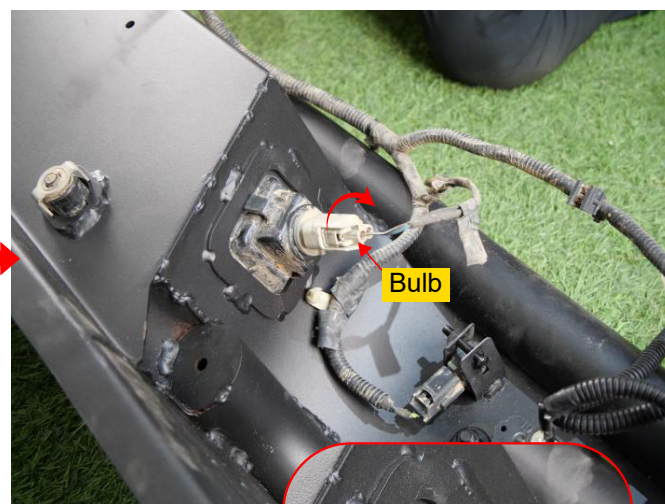
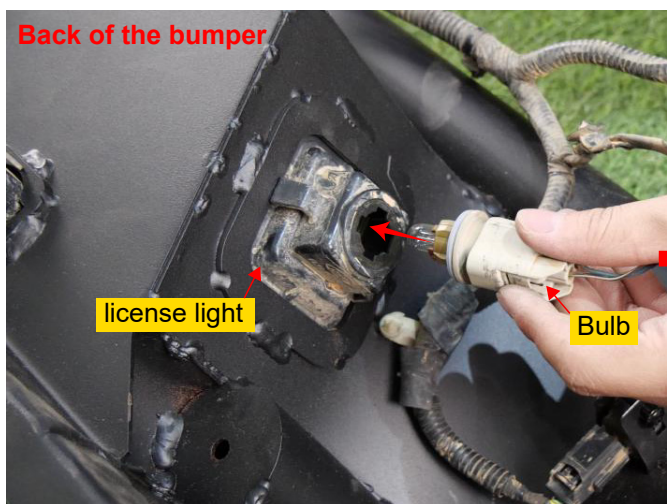

3. Connect the Trailer plug wiring, 4inch Led lights and Cabel wires.

7-Way Connector Wiring/Function Diagram

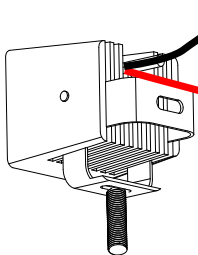
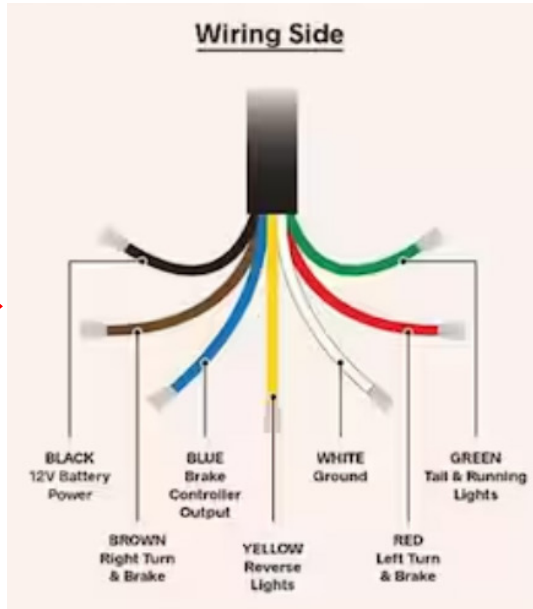
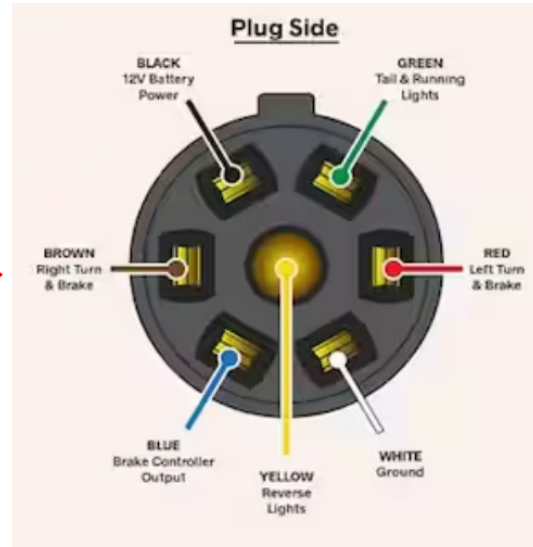

4inch Led light

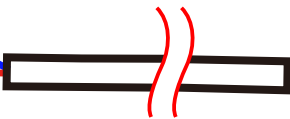



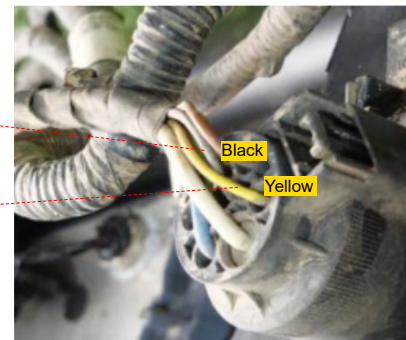



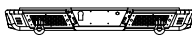
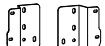

Cabel wire



Trailer plug wiring

Step 5: Install the bumper and tighten the bolts.

① Bumper  x1	② Brackets(L & R)  x1	③ W22: Φ 10  x4	④ W23: Φ 10  x8	⑤ B35: M10x35  x4
⑥ B35: M10  x4	⑦ N24: M12  x6	⑧ B75: M12x45  x6	⑨ W29: Φ 12  x6	⑩ W28: Φ 12  x12

Mounting holes

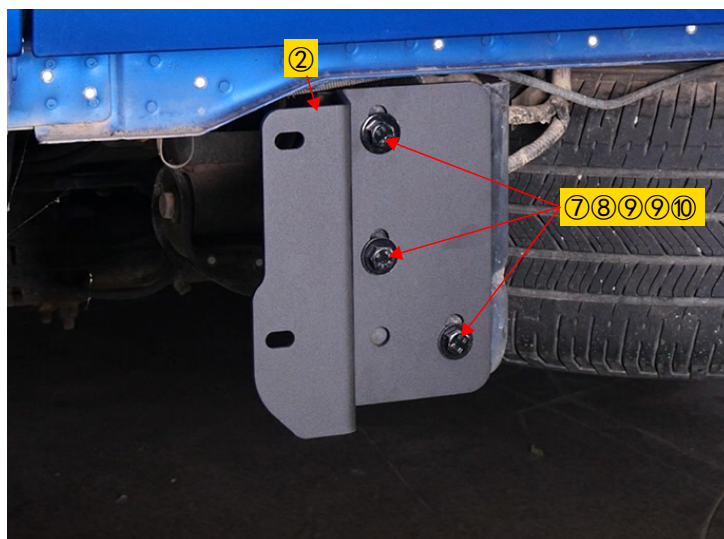
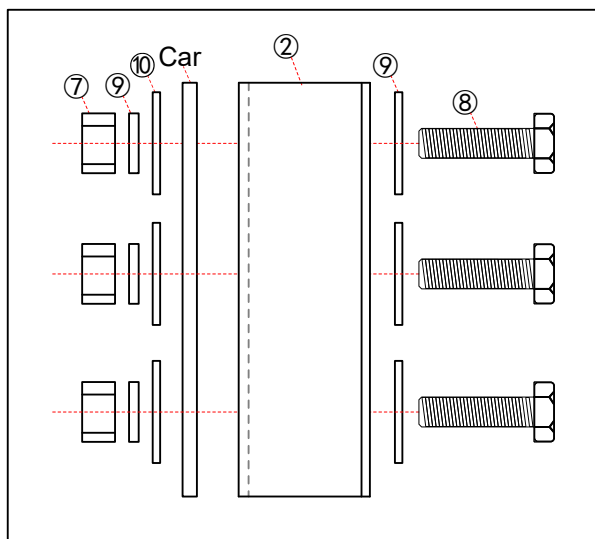

Brackets installed succeed



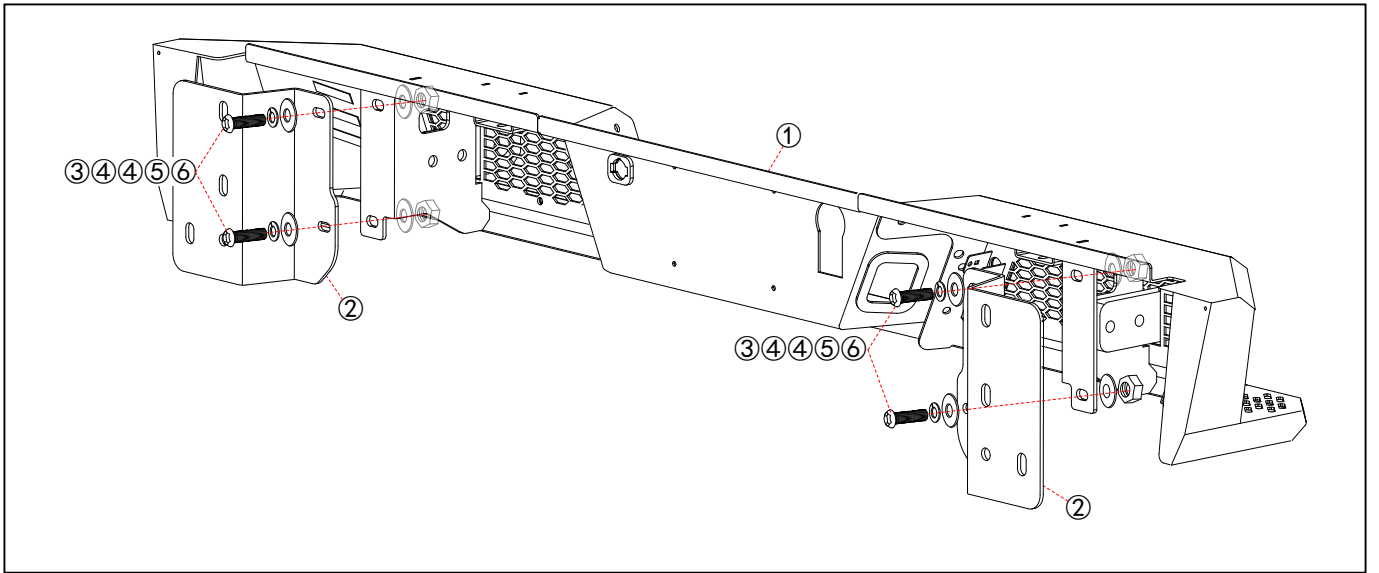

The Rear Bumper is installed.



Step 6: Insert the radar plug.

