

FRONT BUMPER

Mid Bumper

————— User Manual —————

2018-2023 Ford F-150

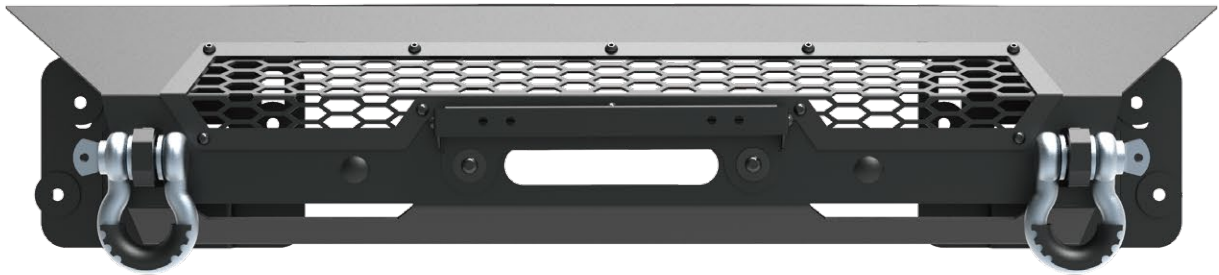

Model:	NF101A105-1A
Material:	Q235A
Product Dimensions:	44.5 x 10.5 x 9.1 inch
Package Dimensions:	48 x 13.2 x 9.4 inch
Product Weight:	57 lbs

※ Thank you for purchasing the FRONT BUMPER Mid Bumper. Please read this manual carefully and keep it properly if you need to refer to it afterward. If you need any support or assistance, please contact us with your product model number and order number, and our support team will help you solve problems.





⚠ WARNING

※ This product is designed primarily to enhance the appearance of the vehicle. Do not rely in any way on the components of this product to protect against injury or death in the event of an accident. To reduce the risk of serious injury or property damage, please read all safety messages and understand all instructions and procedure notices before attempting to install or use this product.



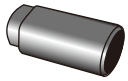

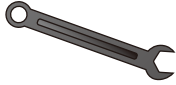

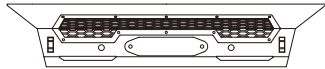
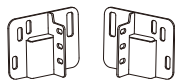

⚠ CAUTION

※ Properly torque and recheck fasteners and security of step tread after 250 miles and inspect frequently. Do not use if damaged.

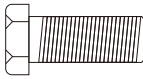
REQUIRED TOOLS

Socket 	Ratchet 	Wrench 	Allen Wrench 	Safety Glasses 
---	--	---	--	---

Parts Information

NO.	Parts Name	Size	Line Graph	Qty	Color	
①	/	Mid Bumper	/		1	Black
②	/	Brackets L/R	/		1	Black
③	/	License Bracket	/		1	Black
④	/	Shackles	/		2	Black
⑤	B68	Hex Bolts	M12x40		9	Dacro Black
⑥	W25	Spring Washer	Φ12		9	Dacro Black
⑦	W27	Flat Washer	Φ12x30x3		13	Dacro Black
⑧	/	Flat Washer	Φ12x44x3		7	Dacro Black
⑨	N19	Hex Nuts	M12		9	Dacro Black
⑩	B46	Half Head Allen Bolts	M6x40		3	Dacro Black
⑪	N11	Hex Lock Nuts	M6		3	Dacro Black

※Note: spare parts such as B68、W25、W27、N19、B46、N11 are provided with 1PCS each (included in the number of parts details).

Installation Instructions

Step 1: Open the carton and take out the parts. Check whether the number of components is complete.

Step 2: Remove the original bumper and prepare the parts needed to install the bumper.

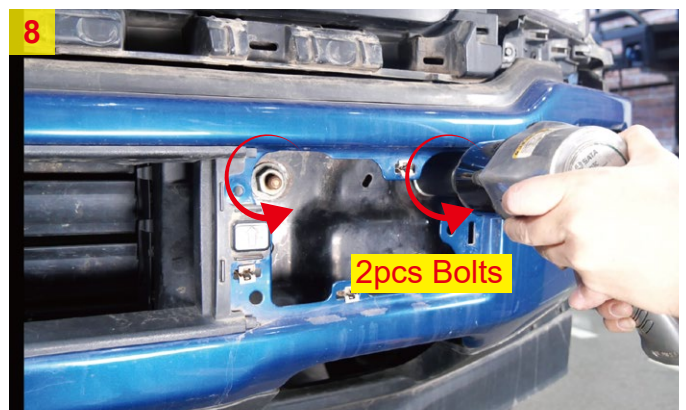
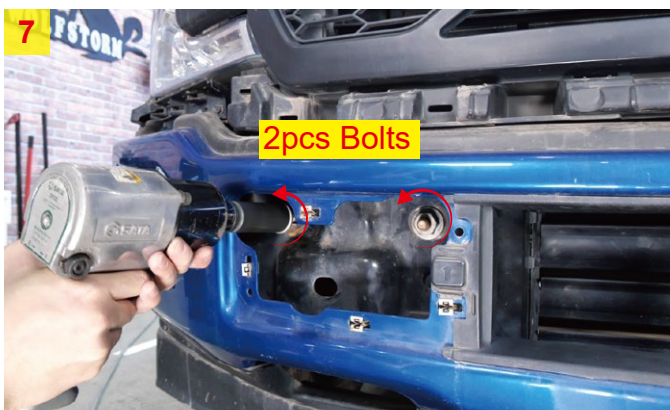
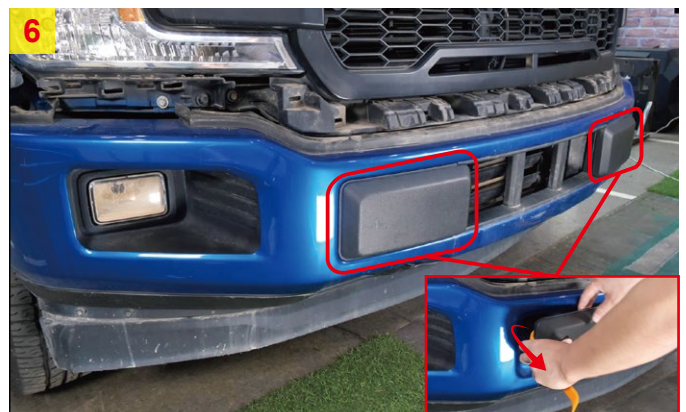

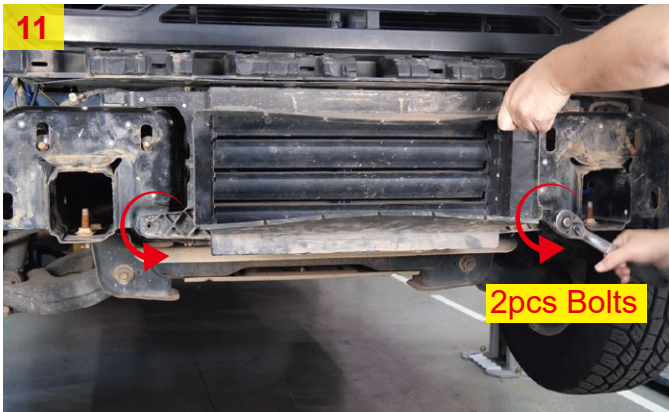
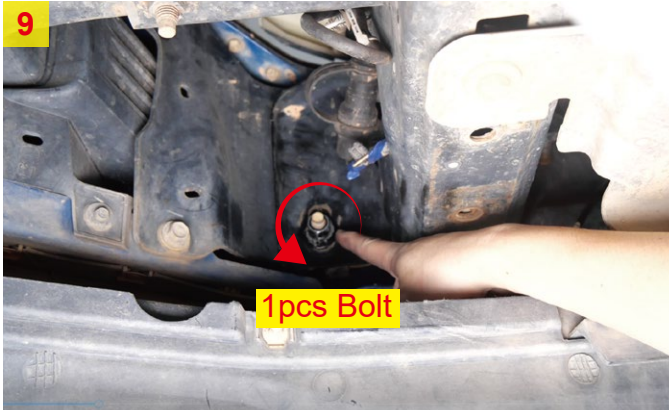

Step 3: Install the Shackles.

- A. Take out the bolts into the bumper.
- B. Install the bolts of Decorative Plate and license bracket on step A.

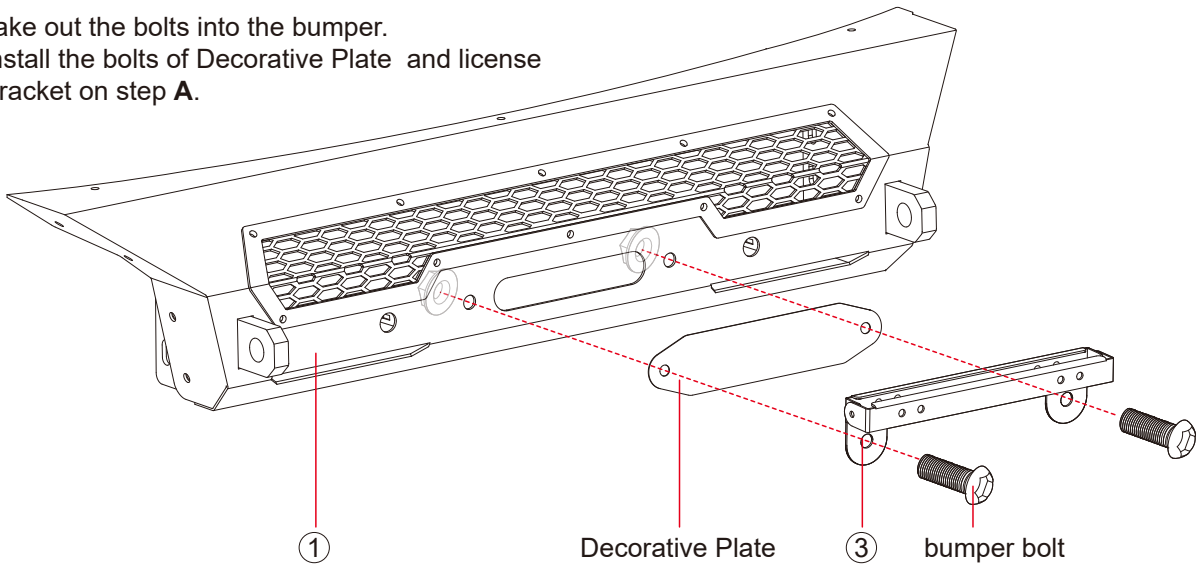

Have not winch plate →

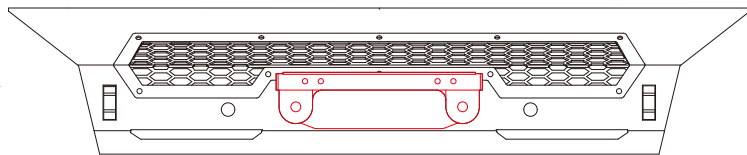

or

Install winch plate →

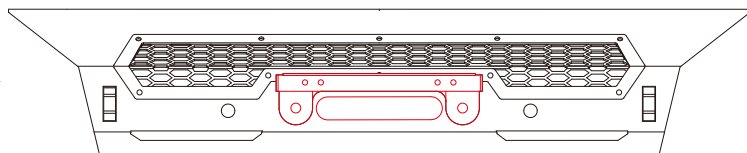

Step 4: Install the Radar Probe.

Note: If the car does not have a radar probe, this step can be ignored.

⑩ B46: M6x40  x2	⑪ N11: M6  x2
--	---

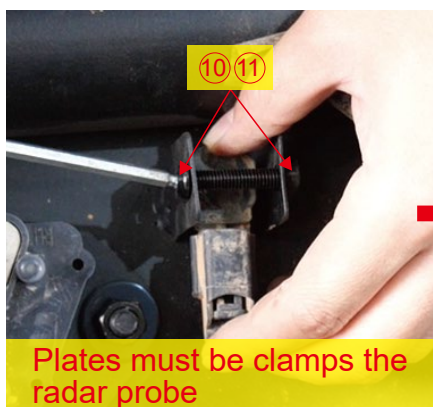
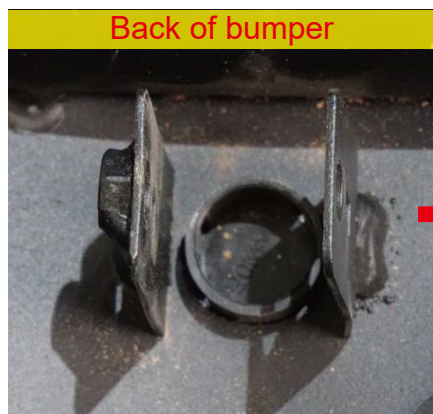
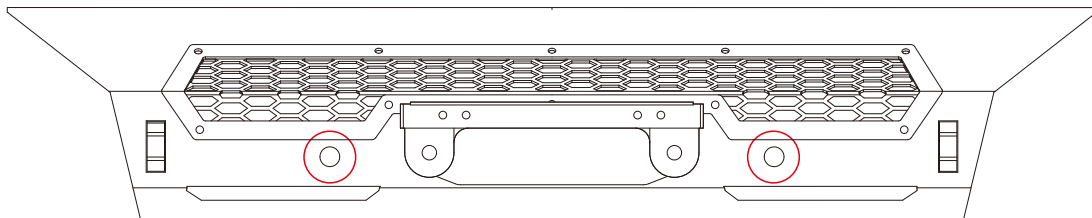



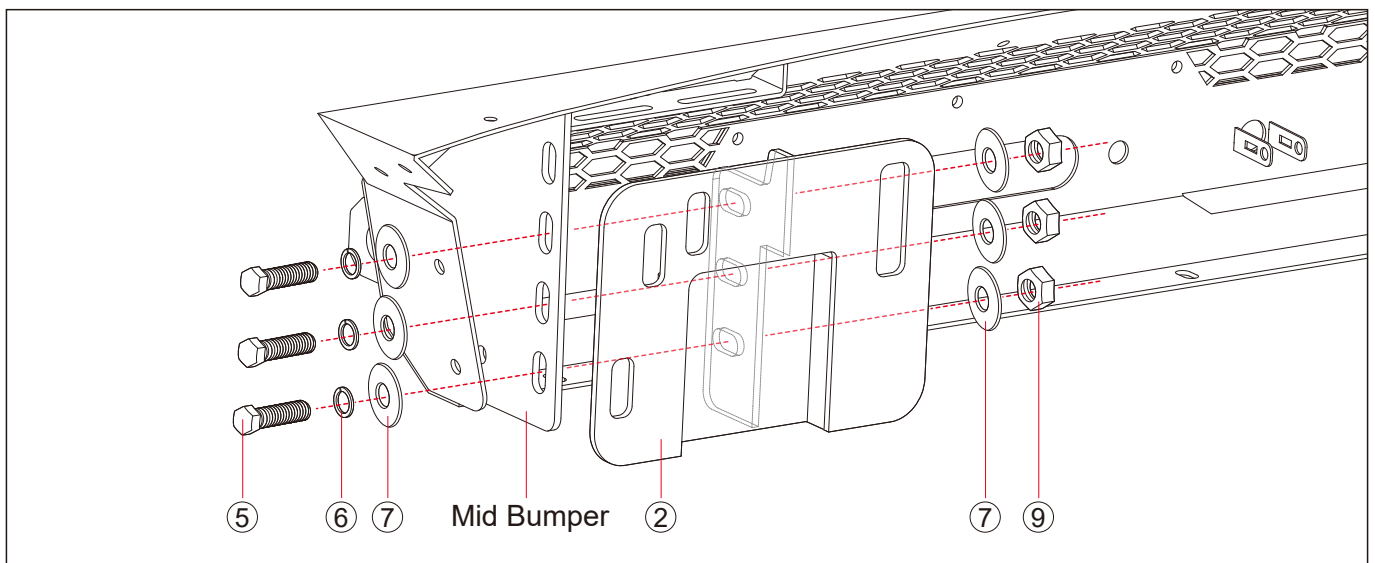
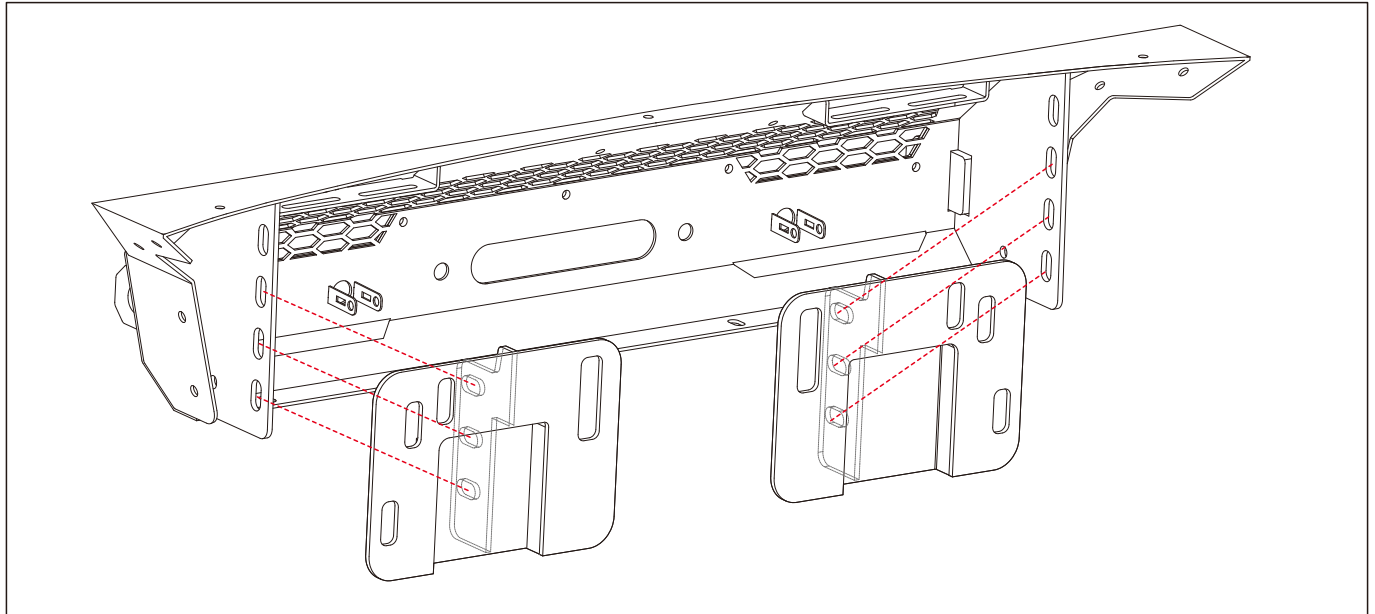
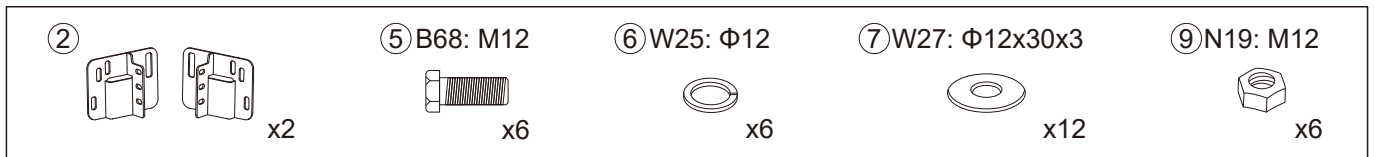

Step 5: Install the Bracket L/R.

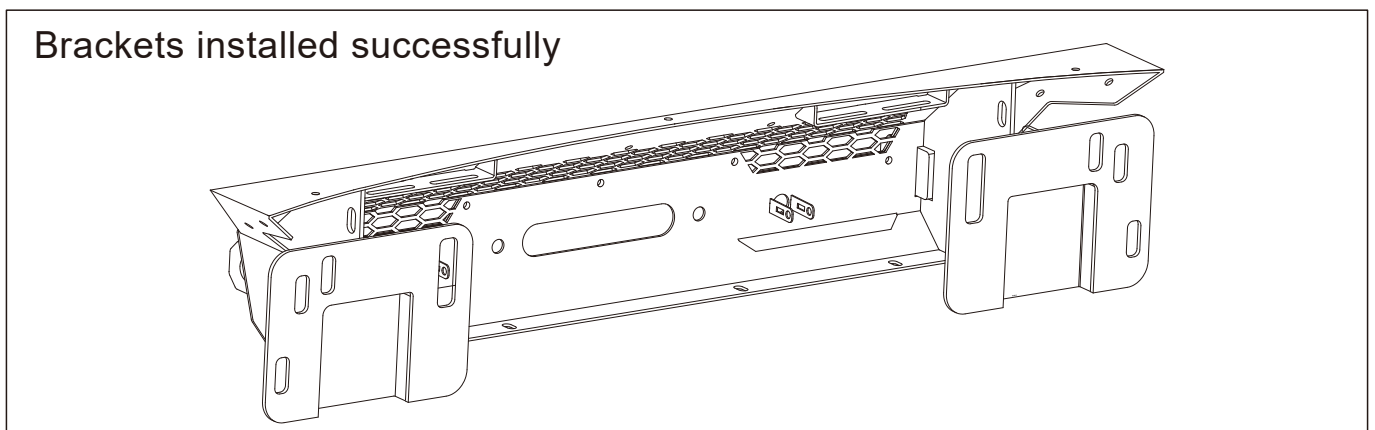

Brackets installed successfully



Step 6: Install the Mid Bumper.

⑤ B68: M12  x2	⑥ W25: Φ12  x2	⑧ Φ12x44x3  x6	⑨ N19: M12  x2
---	---	---	---

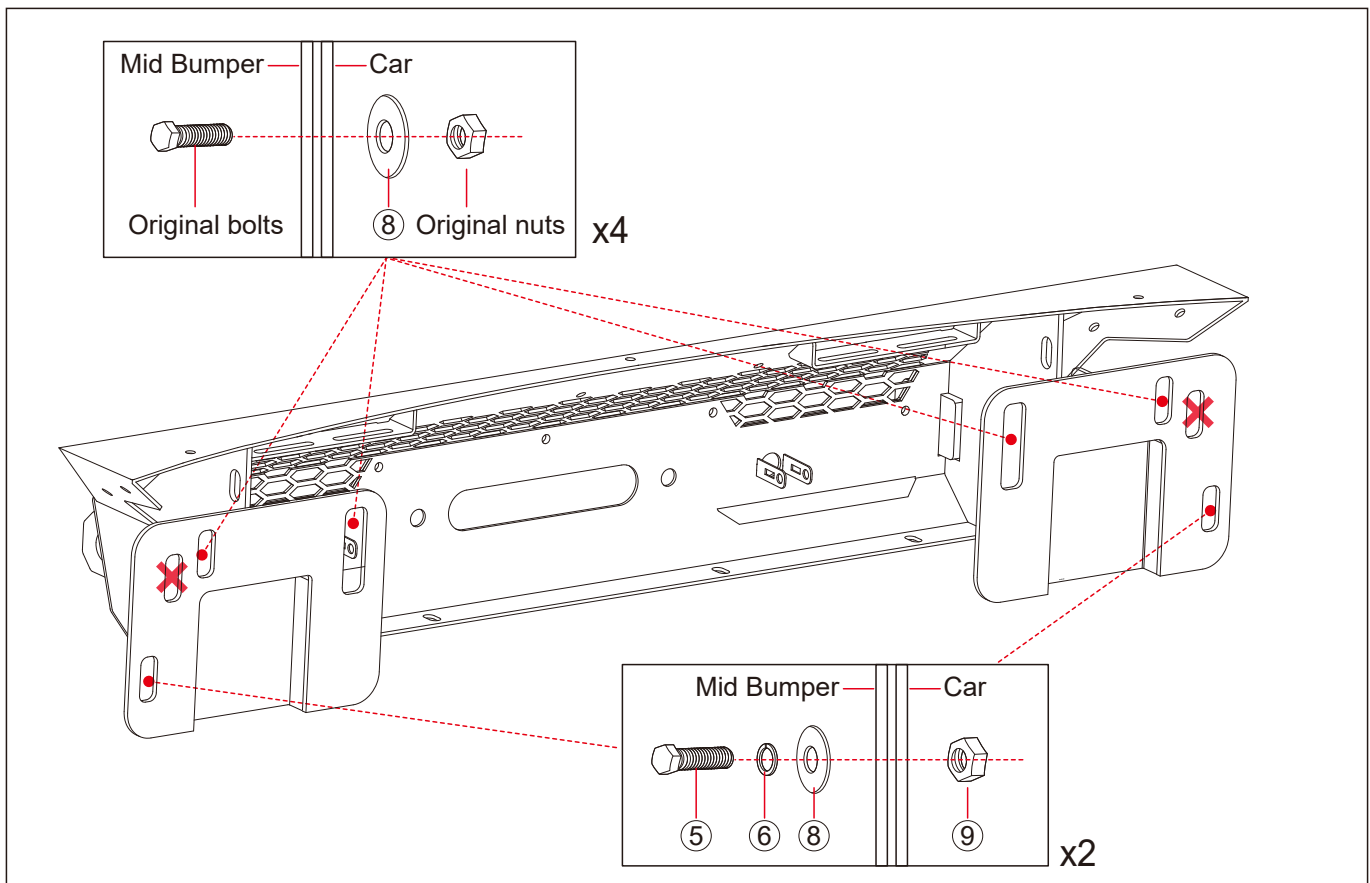

Step 7: Install the Shackles.

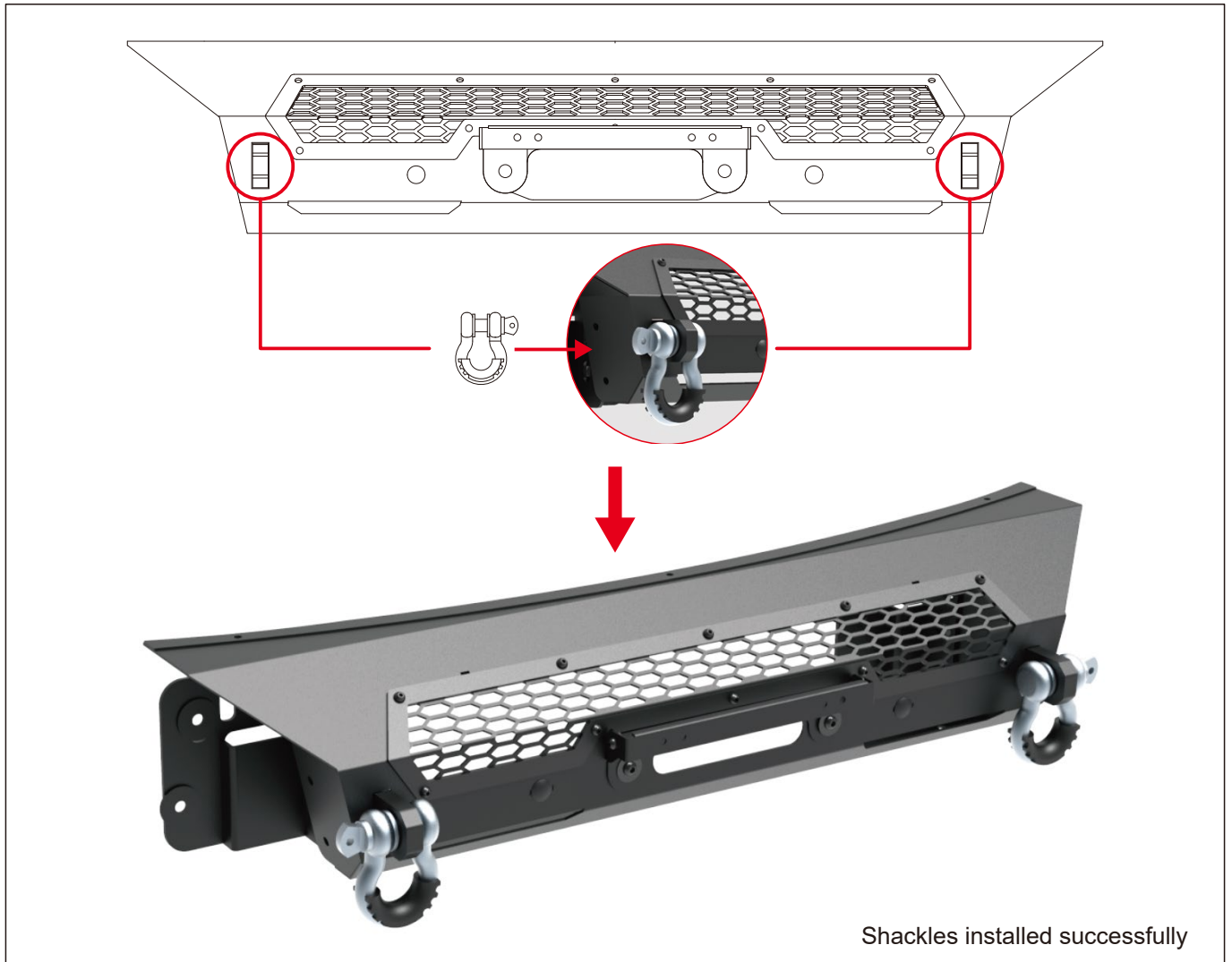

FRONT BUMPER SIDE WINGS

————— User Manual —————

2018-2023 Ford F-150

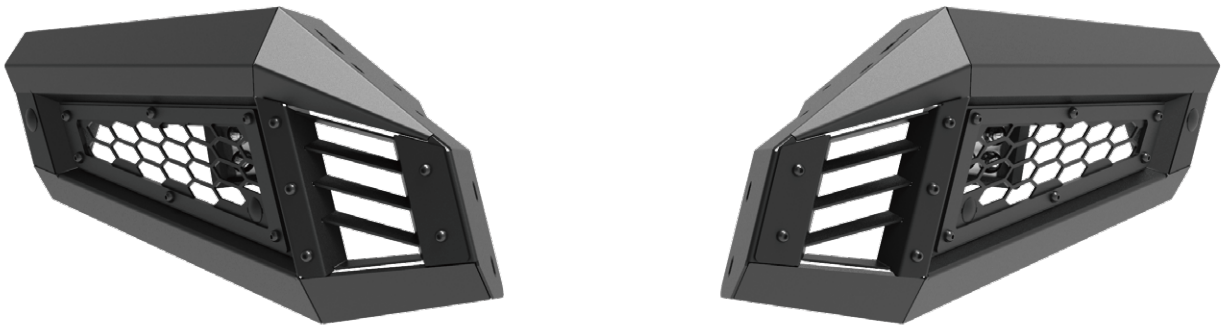

Model:	NF101A105-2A
Material:	Q235A
Product Dimensions:	22.1 x 24 x 11.3 inch
Package Dimensions:	34.2 x 21.1 x 10.2 inch
Product Weight:	39.5 lbs

※ Thank you for purchasing the FRONT BUMPER Side Wings. Please read this manual carefully and keep it properly if you need to refer to it afterward. If you need any support or assistance, please contact us with your product model number and order number, and our support team will help you solve problems.

⚠ WARNING

※ This product is designed primarily to enhance the appearance of the vehicle. Do not rely in any way on the components of this product to protect against injury or death in the event of an accident. To reduce the risk of serious injury or property damage, please read all safety messages and understand all instructions and procedure notices before attempting to install or use this product.

⚠ CAUTION

※ Properly torque and recheck fasteners and security of step tread after 250 miles and inspect frequently. Do not use if damaged.

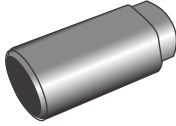
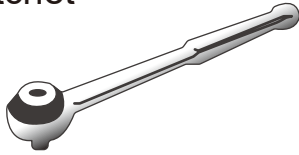
REQUIRED TOOLS	Socket		Ratchet	

Parts Information

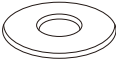
NO.		Parts Name	Size	Line Graph	Qty	Color
①	/	Side Wings L/R	/		1	Black
②	/	Light brackets	/		2	Black
③	/	Plates L/R	/		2	Black
④	/	4 Inch Ledlight	/		2	/
⑤	/	Cable Wires	2x0.75mm		2	/
⑥	/	Wire Connector Clips	/		5	/
⑦	B22	Hex Flange Bolts	M8x25		13	Dacro Black
⑧	W19	Flat Washer	Φ8x24x2		7	Dacro Black
⑨	N14	Hex Flange Nuts	M8		11	Dacro Black
⑩	B46	Half Head Allen Bolts	M6x40		5	Dacro Black
⑪	N11	Hex Lock Nuts	M6		5	Dacro Black

※**Note:**

Spare parts such as B22、 W19、 N14、 N09、 B46、 N11 are provided with 1PCS each (included in the number of parts details).

Installation Instructions

Step 1: Open the carton and take out the parts. Check whether the number of components is complete.

Step 2: Splicing the Light brackets.

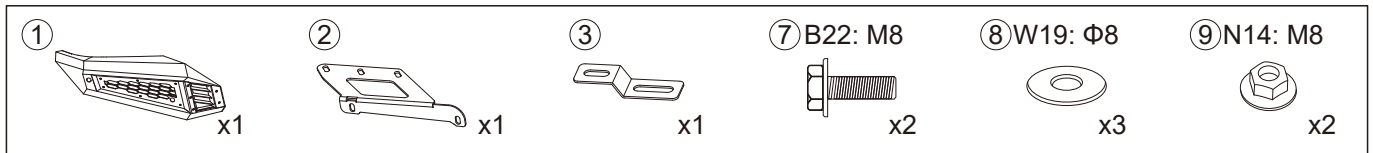

- A. Take out the bolts into the decorative plate.
- B. Install the bolts of decorative plate and light brackets on step A.

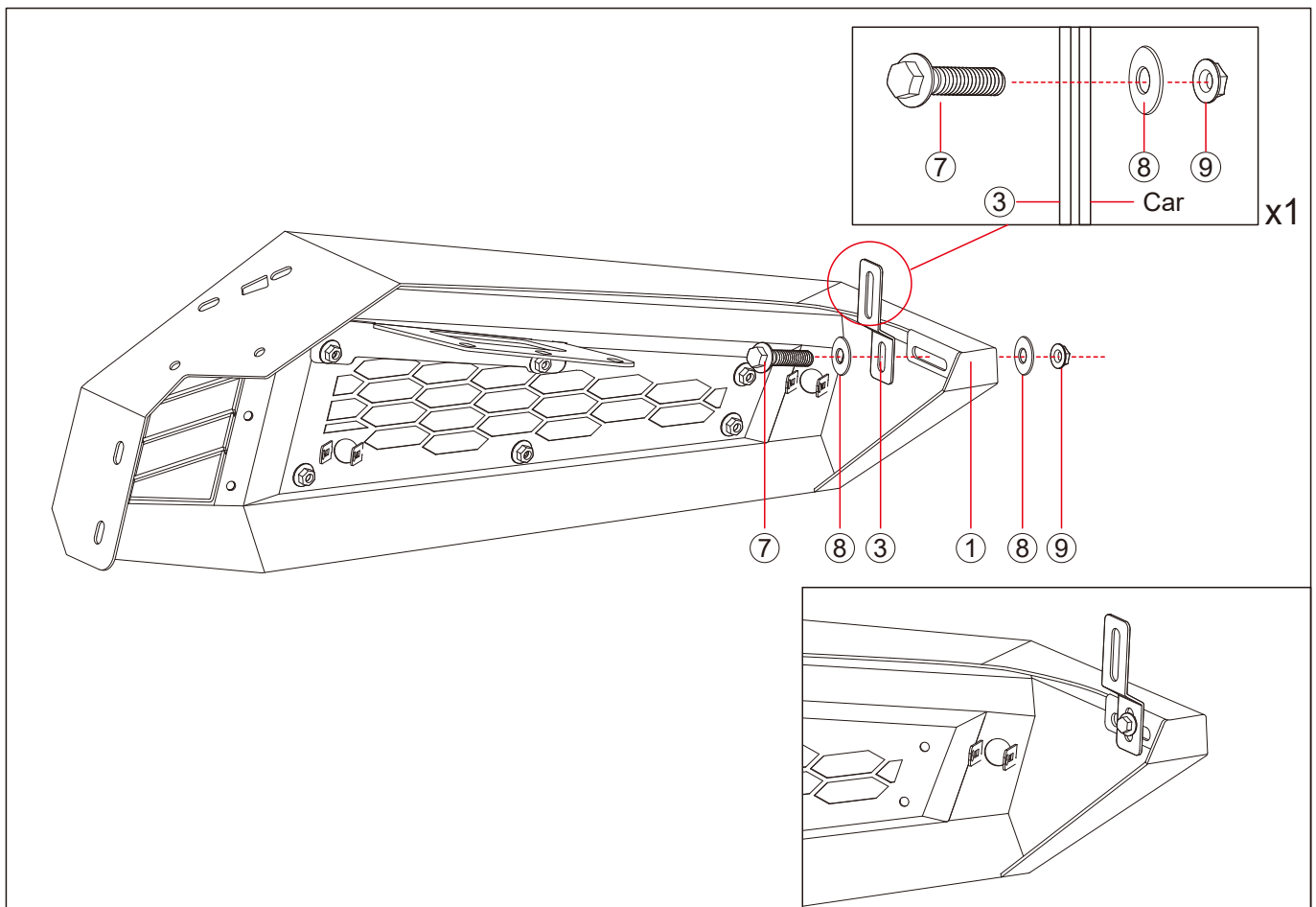
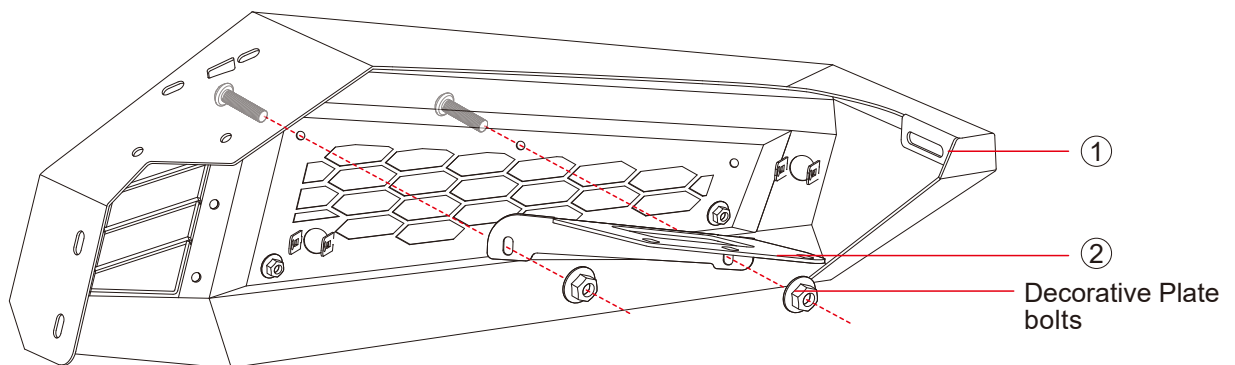

Step 3: Install the 4 Inch Ledlight.

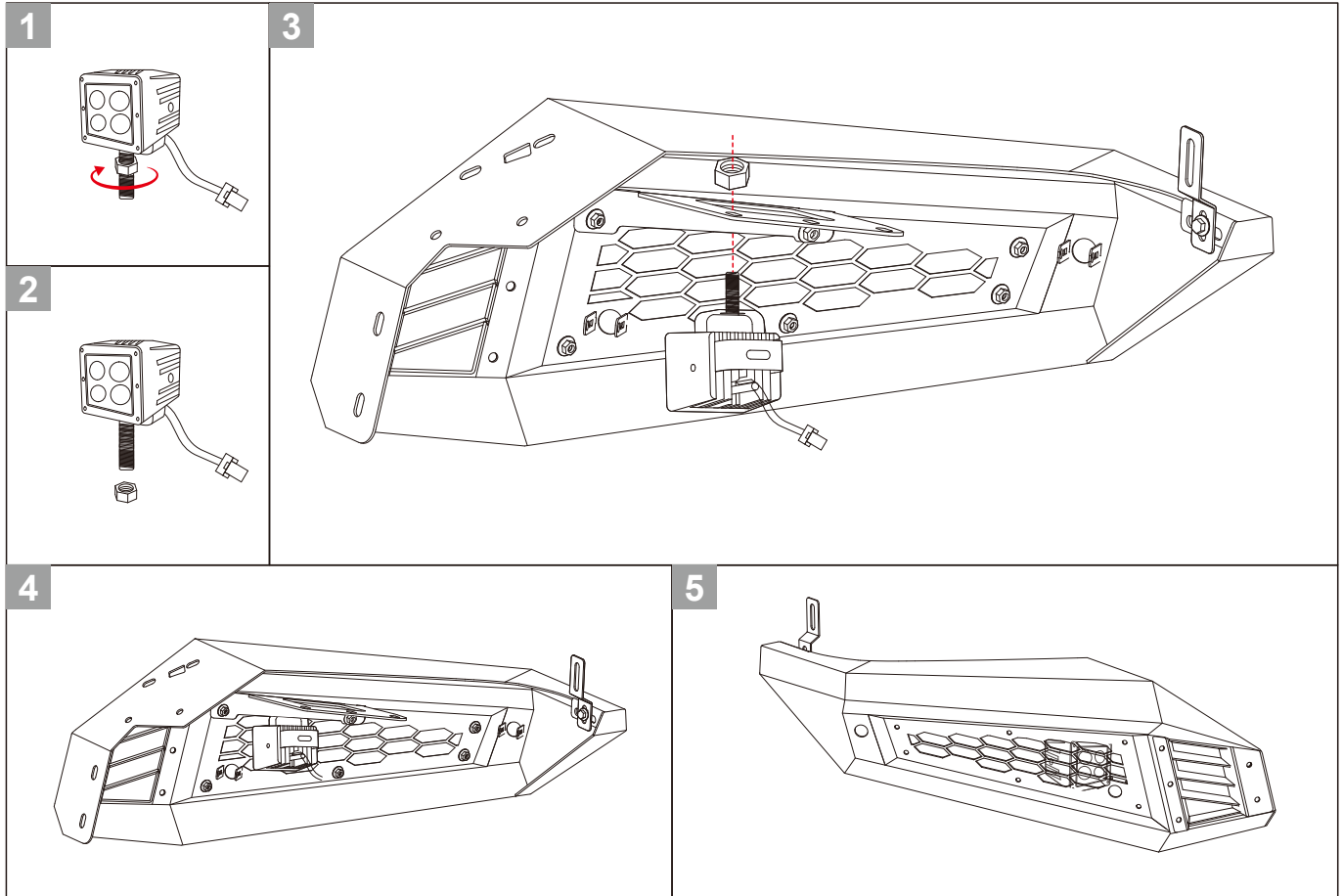

You can connect the 4inch Led light lights wiring harness to the headlight DRLs or fog light wiring. but my suggestion is to connect to the fog lights for on/off control!

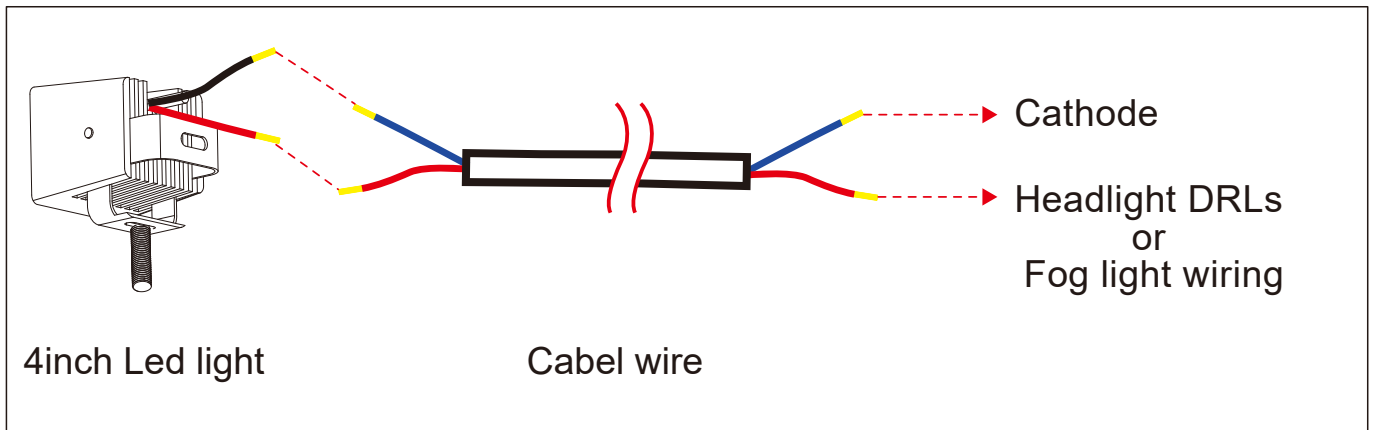

Step 4: Install the Side Wings.

⑦ B22: M8

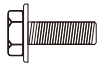

x8

⑨ N14: M8



x6

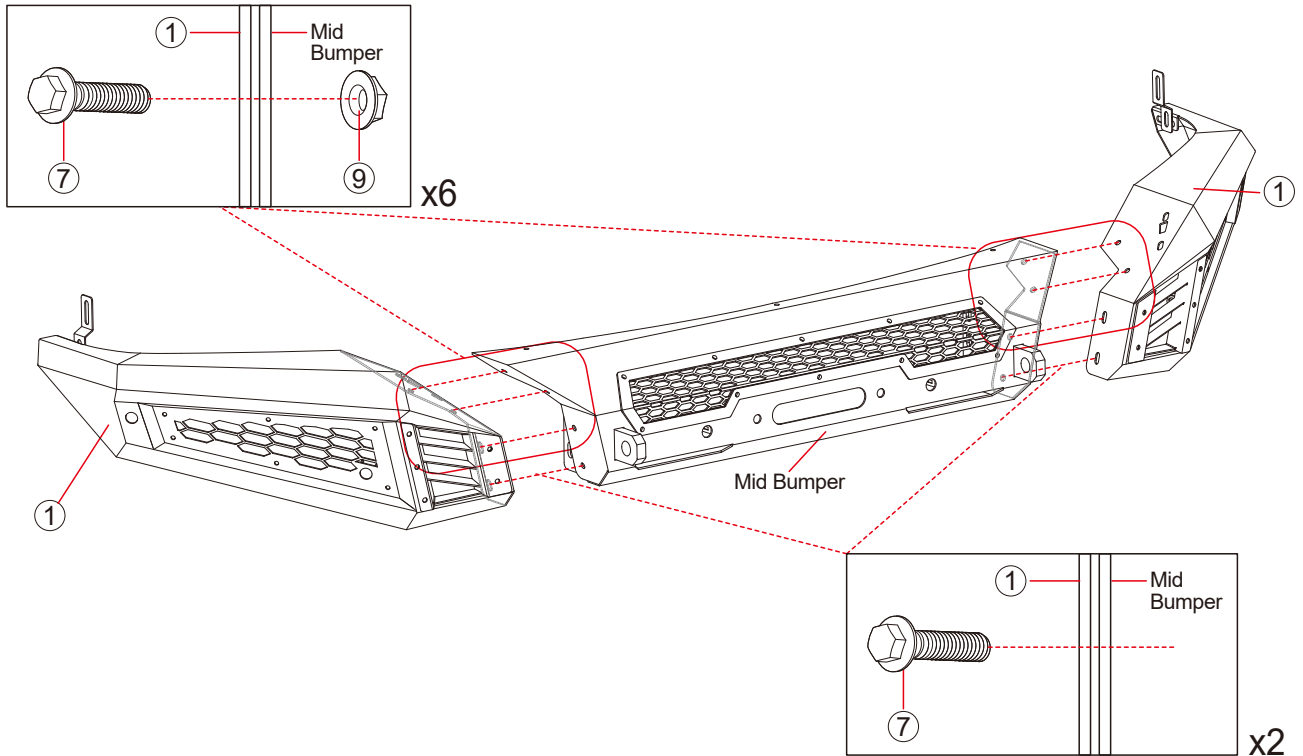

Side Wings is assembled

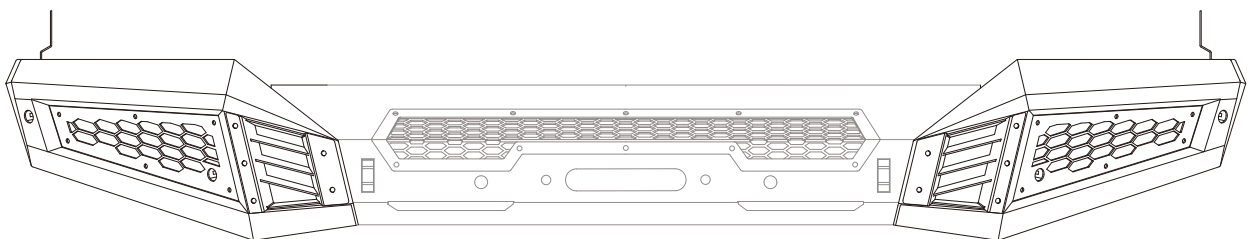

Step 5: Install the Radar Probe.

Note: If the car does not have a radar probe, this step can be ignored.

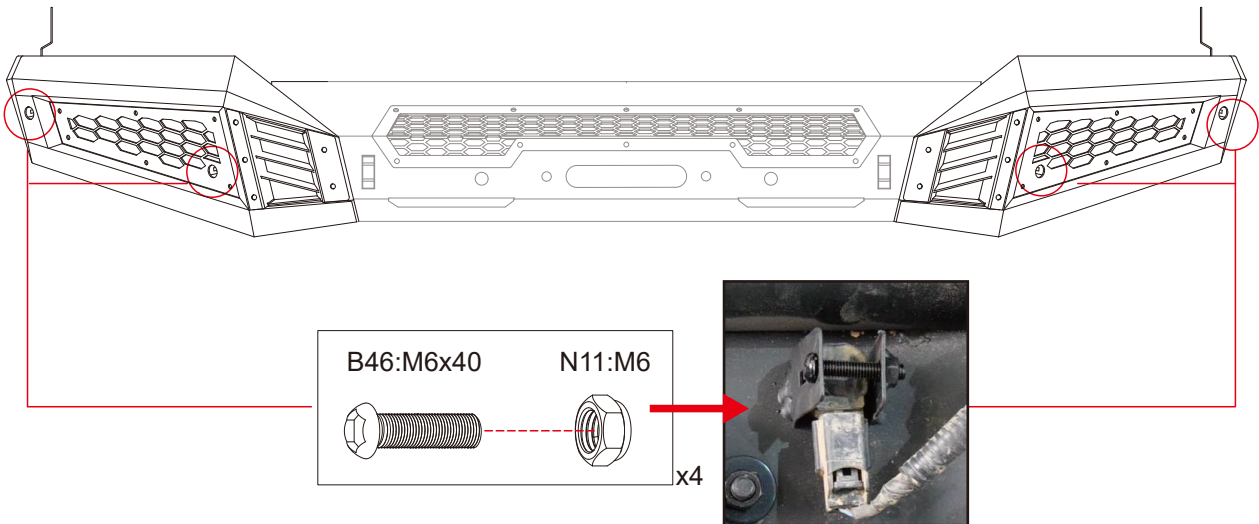

FRONT BUMPER BULL BAR

————— User Manual —————

2018-2020 Ford F-150

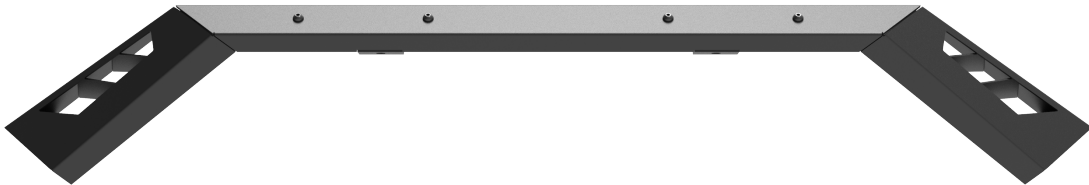

Model:	NF101A105-3A
Material:	Q235A
Product Dimensions:	48.3 x 7.6 x 7.6 inch
Package Dimensions:	5.5 x 5.9 x 33.5 inch
Product Weight:	8.8 lbs

※ Thank you for purchasing the FRONT BUMPER BULL BAR. Please read this manual carefully and keep it properly if you need to refer to it afterward. If you need any support or assistance, please contact us with your product model number and order number, and our support team will help you solve problems.





⚠ WARNING

※ This product is designed primarily to enhance the appearance of the vehicle. Do not rely in any way on the components of this product to protect against injury or death in the event of an accident. To reduce the risk of serious injury or property damage, please read all safety messages and understand all instructions and procedure notices before attempting to install or use this product.

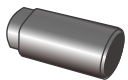

⚠ CAUTION

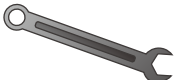
※ Properly torque and recheck fasteners and security of step tread after 250 miles and inspect frequently. Do not use if damaged.

REQUIRED TOOLS

Socket 	Ratchet 	Wrench 	Allen Wrench 	Safety Glasses 
---	--	---	--	---

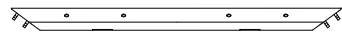
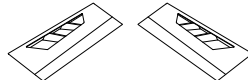
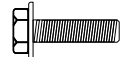
Parts Information

	NO.	Parts Name	Size	Line Graph	Qty	Color
①	/	Bull Bar Connector	/		1	Black
②	/	Left/Right Bull Bar	/		1	Black
③	B22	Hex Flange Bolts	M8x25		5	Dacro Black
④	N14	Flat Washer	M8		9	Dacro Black

※ **Note: spare parts such as B22 and N14 are provided with 1PCS each (included in the number of parts details).**

Installation Instructions

Step 1: Open the carton and take out the parts. Check whether the number of components is complete.

Step 2: Splicing the Bumper.

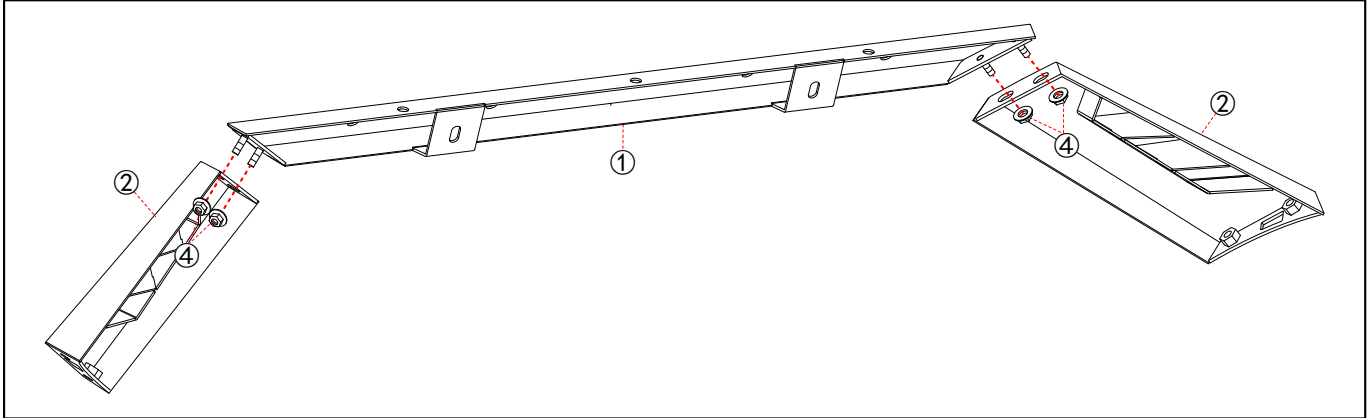

The Bull Bar is assembled.



Step 3: Install the Bull Bar.

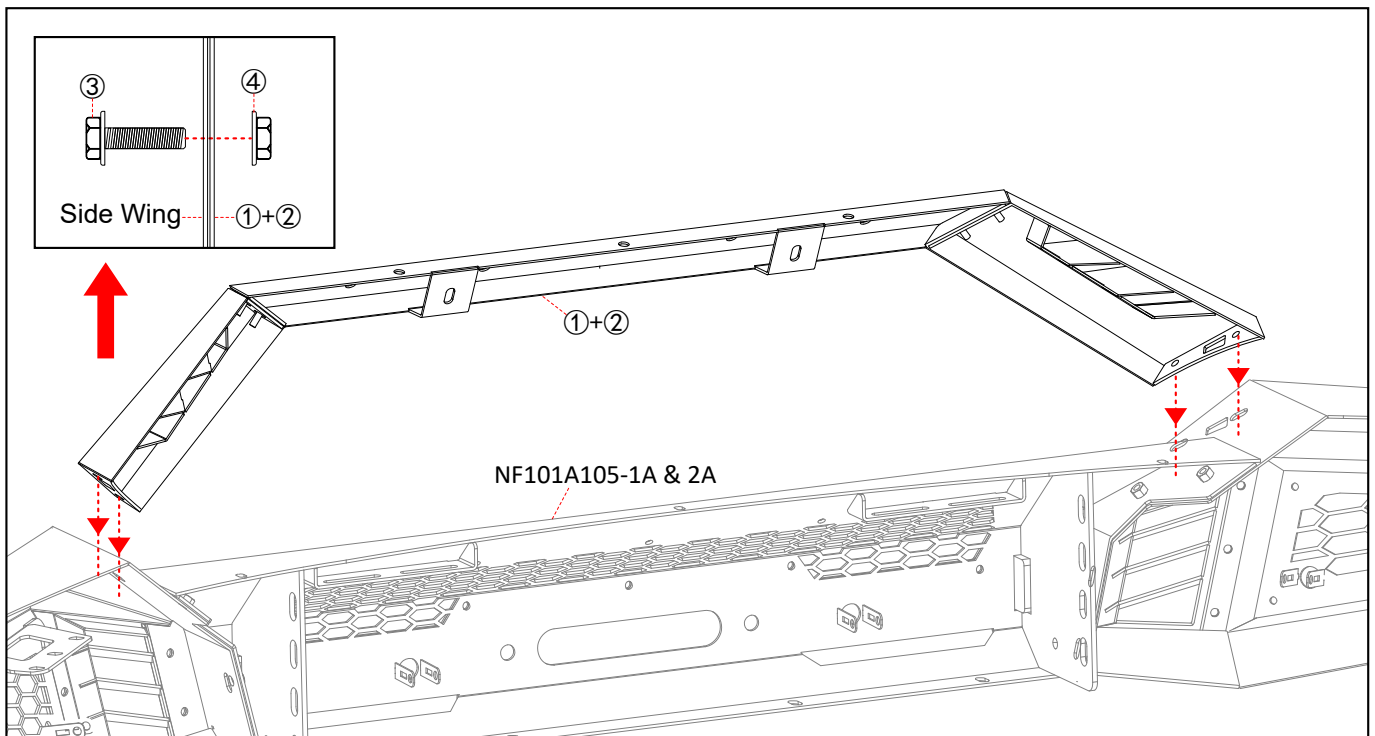

The Bull Bar is installed.



Back of the bumper



****NOTE: This design only fits for NF101A105-1A & 2A***

FRONT BUMPER WINCH PLATE

— User Manual —

2018-2023 Ford F-150

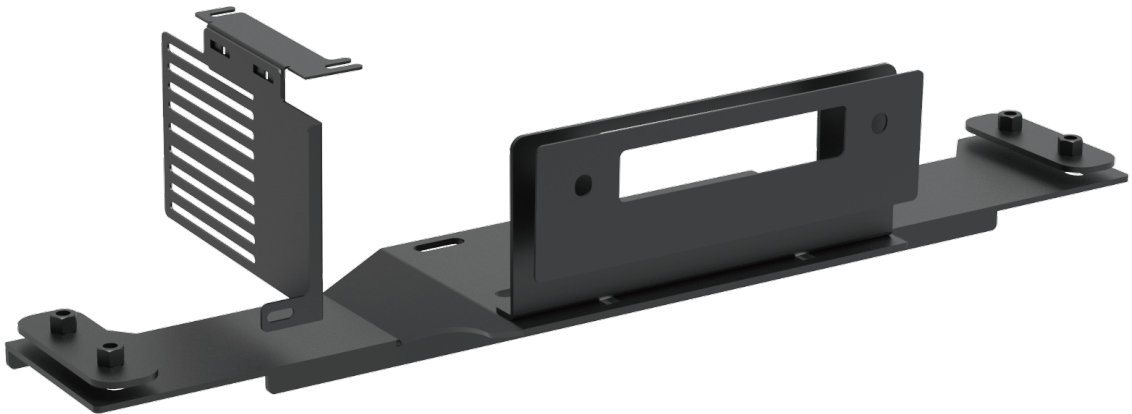

Model:	NF101A105-4
Material:	Q235A
Product Dimensions:	36 x 9.3 x 7.5 inch
Package Dimensions:	38.6 x 12 x 5.1 inch
Product Weight:	24.6 lbs

※ Thank you for purchasing the FRONT BUMPER WINCH PLATE. Please read this manual carefully and keep it properly if you need to refer to it afterward. If you need any support or assistance, please contact us with your product model number and order number, and our support team will help you solve problems.







⚠ WARNING

※ This product is designed primarily to enhance the appearance of the vehicle. Do not rely in any way on the components of this product to protect against injury or death in the event of an accident. To reduce the risk of serious injury or property damage, please read all safety messages and understand all instructions and procedure notices before attempting to install or use this product.

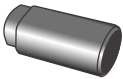

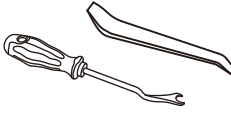
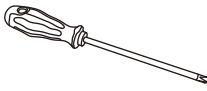

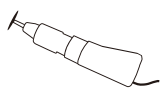
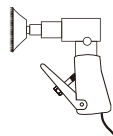

⚠ CAUTION



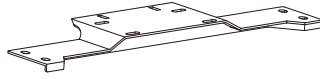
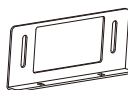
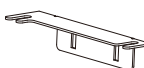

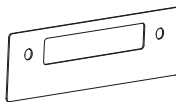
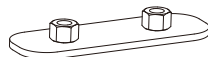

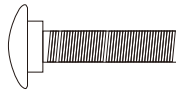

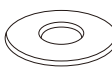
※ Properly torque and recheck fasteners and security of step tread after 250 miles and inspect frequently. Do not use if damaged.

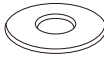
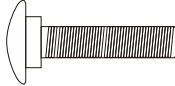
REQUIRED TOOLS

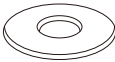
Socket 	Ratchet 	Panel Remover 	Phillips Screwdriver 	Painter's tape 
Power Cutting Tool 	Angle Grinder 	Safety Glasses 		

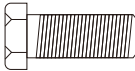
Parts Information

NO.		Parts Name	Size	Line Graph	Qty	Color
①	/	Winch Bracket 1	/		1	Black
②	/	Winch Bracket 2	/		1	Black
③	/	Relocation Bracket 1	/		1	Black
④	/	Relocation Bracket 2	/		1	Black
⑤	/	License Plate	/		1	Black
⑥	/	Nut Plates	/		2	Black
⑦	/	License Bracket	/		1	Black
⑧	B34	Square Neck Bolt	M10x35		3	Dacro Black
⑨	W22	Spring Washer	Φ10		3	Dacro Black
⑩	W23	Flat Washer	Φ10x25x2		3	Dacro Black

NO.		Parts Name	Size	Line Graph	Qty	Color
⑪	N15	Hex Nuts	M10		3	Dacro Black
⑫	/	Flat Washer	M6		3	PVC
⑬	B09	Square Neck Bolt	M6x20		3	Dacro Black
⑭	N09	Hex Lock Nuts	M6		3	Dacro Black
⑮	W37	Flat Washer	Φ6x24x2		7	Dacro Black
⑯	B37	Hex Bolts	M12x35		3	Dacro Black
⑰	B76	Hex Bolts	M12x50		5	Dacro Black
⑱	W25	Spring Washer	Φ12		7	Dacro Black
⑲	W27	Flat Washer	Φ12x30x3		7	Dacro Black
⑳	N19	Hex Nuts	M12		3	Dacro Black

NOTE:

Spare parts such as B34、W22、W23、N15、B09、N09、W37、B37、B76、W25、W27、N19 are provided with 1PCS each (included in the number of parts details).

Tips:

1. Please purchase the winch control box relocation cable according to the winch specifications, it is recommended to purchase more than 1.5 metres of winch cable.
2. It is recommended to buy the cable with the colour corresponding to the function of the winch.
3. If the colour of the winch control box extension cable you purchased does not meet the requirements, you can mark the winch screw posts with tape or colour pens in the colour corresponding to the function of the winch.



Installation Instructions

Step 1: Open the carton and take out the parts. Check whether the number of components is complete.

Step 2:
Using a 7mm Socket, remove the two most forward bolts in the wheel well of your vehicle. (figure1)



Step 3:
Pull the fender flare free from the valance. Then, pull the valance free to expose the air dam sitting behind it. (figure2~5)



Step 4:
Pull the front plastic pods off each end of the OEM bumper. (figure6)

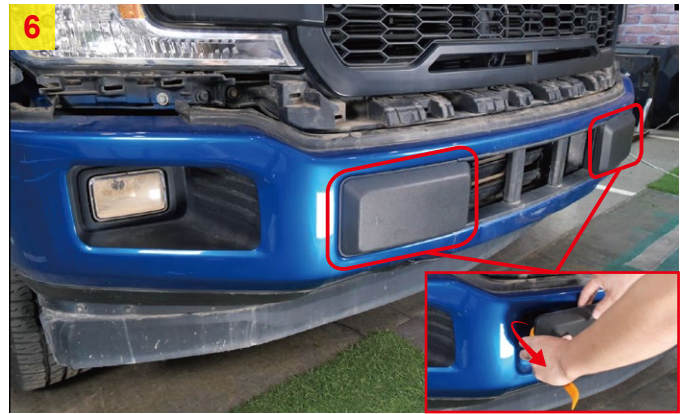

Step 5:
Using a 21mm Socket, remove the OEM bumper mounting bolts. There are two (per side) on the front side of the bumper and one (per side) on the rear side of the bumper. (figure7~9)

Step 6:
Remove the OEM bumper. (figure10)

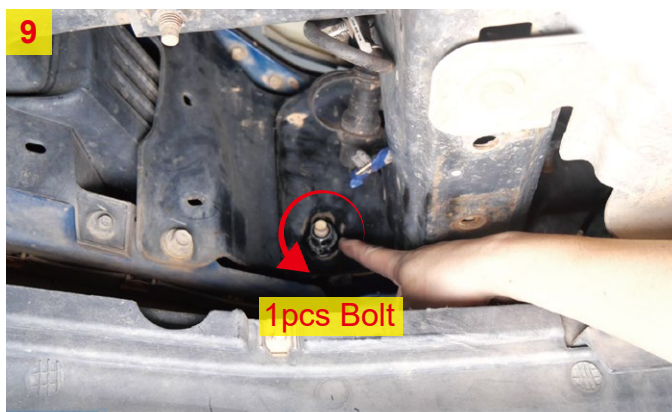
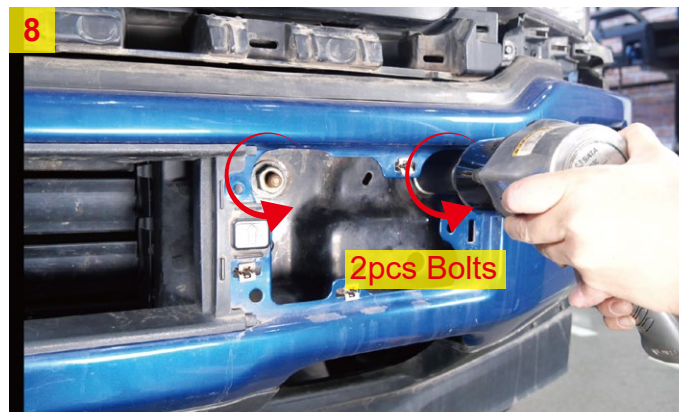
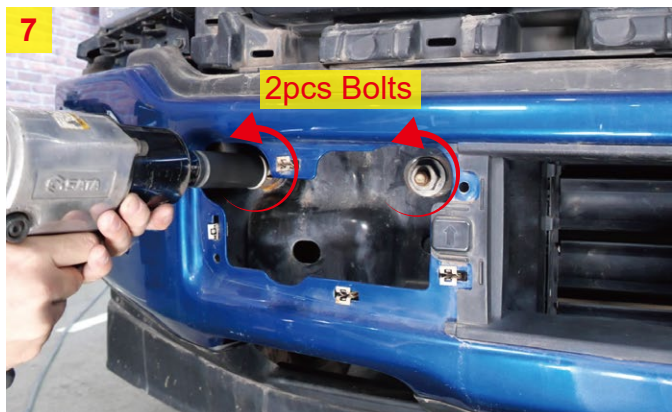

Step 7:

If you have an Ecoboost engine, remove the outer plastic scoop from in front of your OEM Intercooler. There is a series of plastic clips around the perimeter that hold it on. Release those clips to remove the scoop. (figure11~12)

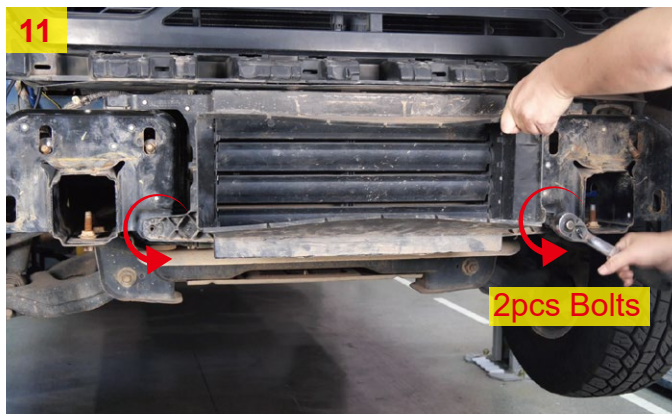

NOTICE:

The following operations are based on the WARN VR EVO winch as an example, please operate according to the winch you have

Step 8:

Remove the winch control box. (figure13~14)



Step 9:

Remove this top cover there are four Phillips head screws that come out and disconnect the plug. (figure15~16)

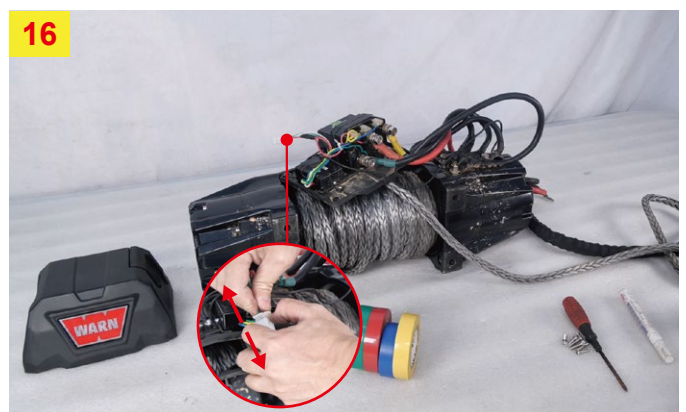

Step 10:

Mark the screw posts with a paint pen or tape of the corresponding harness colour, then take off all nuts. (figure17~21)

Step 11:

Use the Phillips screwdriver Remove the screw that hold the ground wire. (figure22)

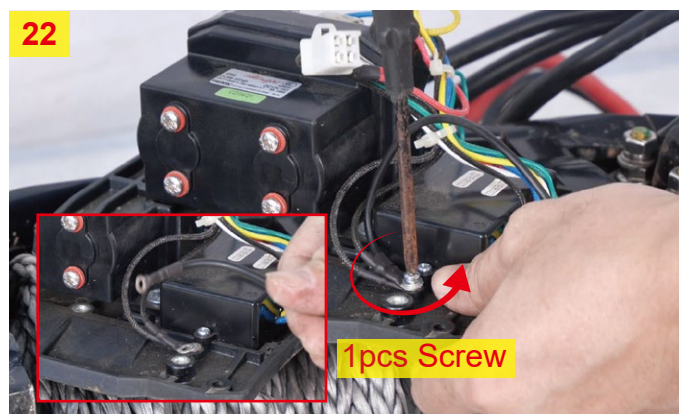
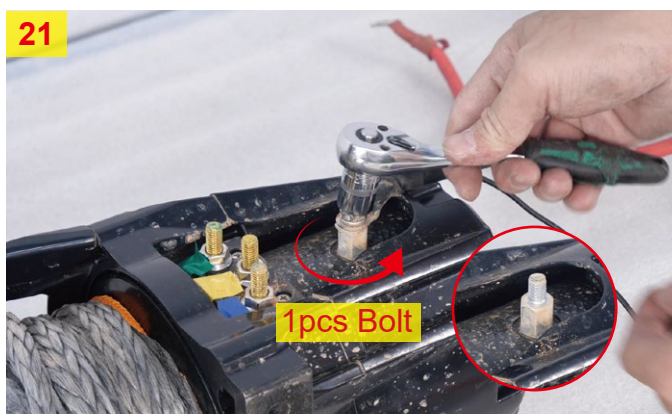
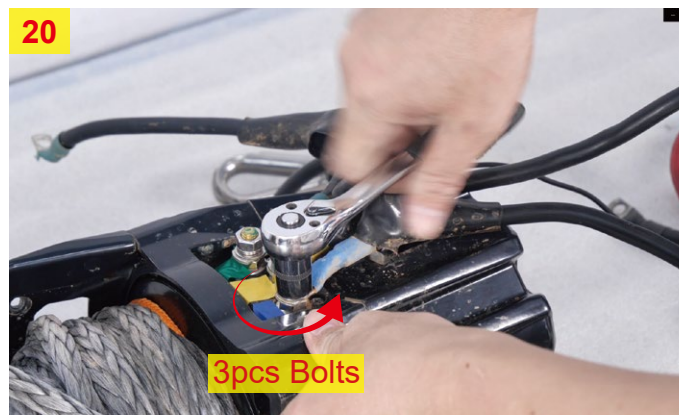
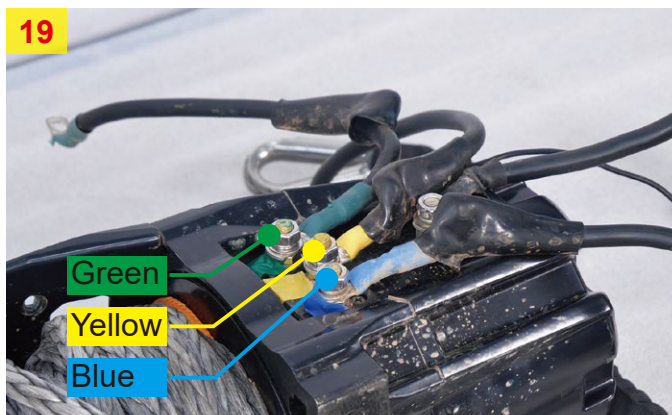
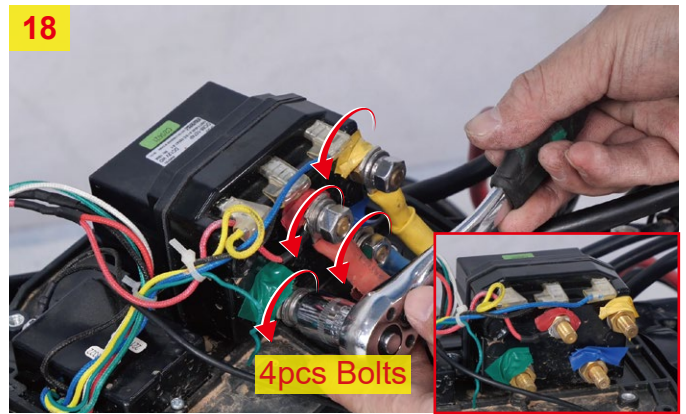
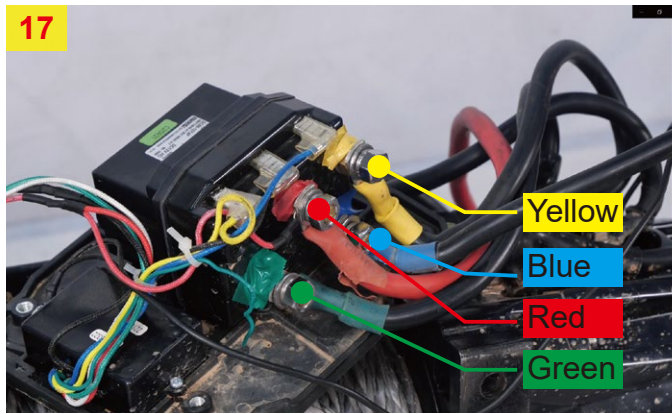

Step 12:

If you have purchased an extension power cord that is not the same colour as the winch power cord, then mark the extension cord with a paint pen or tape. (figure23)



Step 13: Reinstatement as per step9~11. (figure24~27)

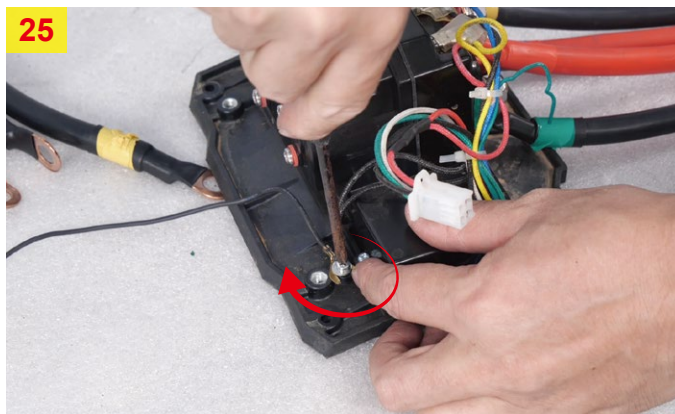
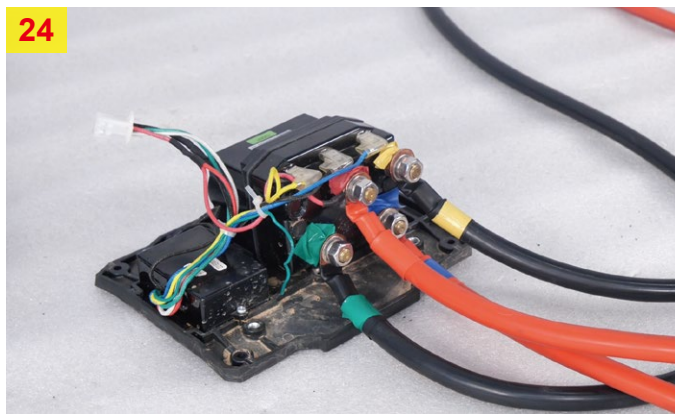

Step 14:
Use a tape to tidy up the wiring harness. (figure28)



Step 15:

- ✘ If your vehicle version is a **2018-2020 Ford F-150**, secure the power control box to relocation bracket 2 with the original screws. (figure29)
- ✘ If your vehicle version is a **2021-2023 Ford F-150**, you will first need to use a cutter to cut the mounting lugs in the upper right corner of the relocation bracket 2 (figure29-1), then secure the power control box to the relocation bracket 2 with the original screws. (figure29)

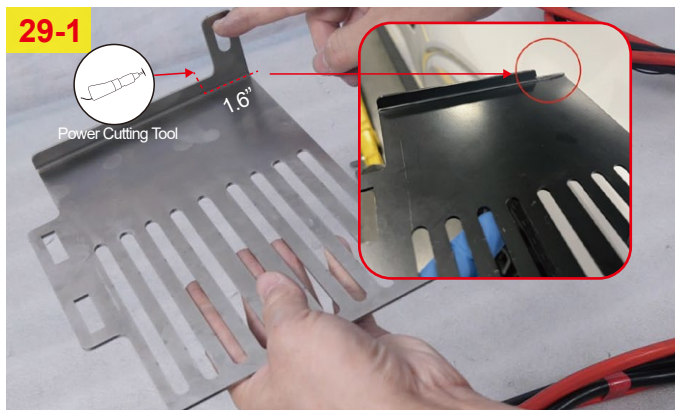
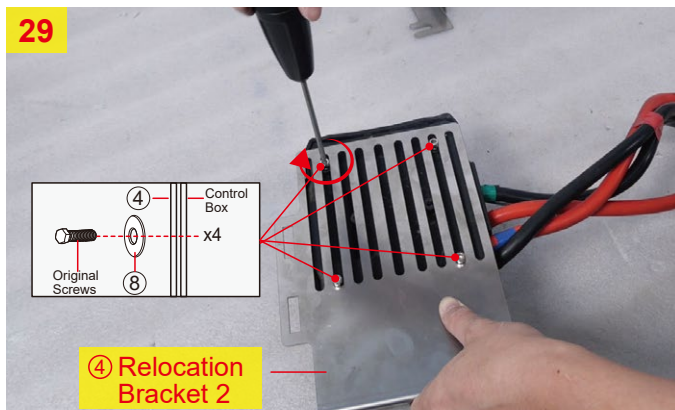

Step 16:

Relocation bracket 1 Install our accessory bolts and then secure relocation bracket 1 to the body with the original bolts. (figure30~32)

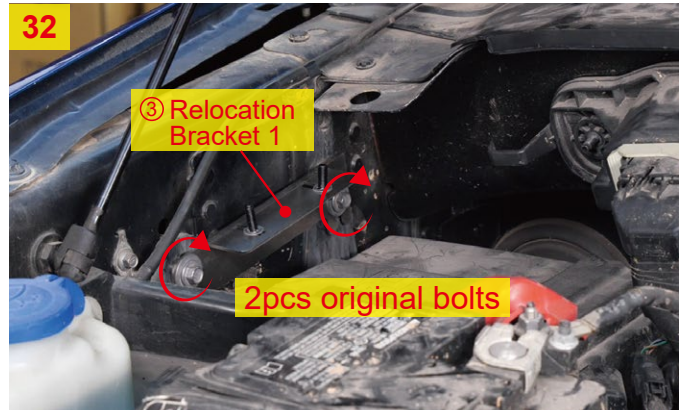
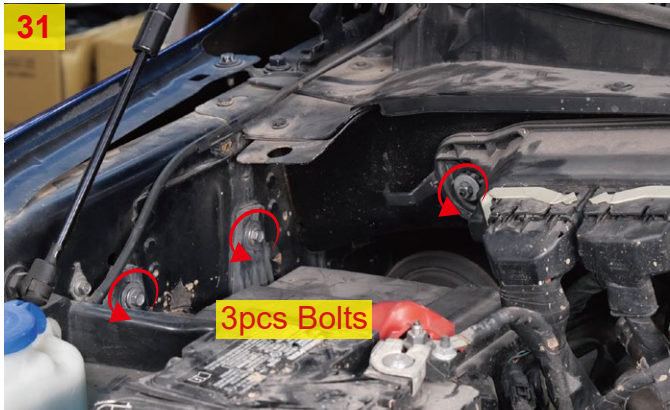
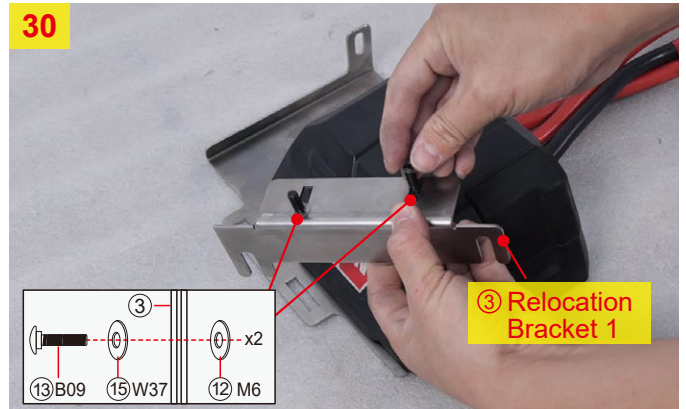

Step 17:

- ✘ If your vehicle version is a **2018-2020 Ford F-150**, you need to fix the mounting holes in the top right corner of the relocation kit to the body with the original bolts, and the other two mounting holes to the relocation bracket 1. (figure33)
- ✘ If your vehicle version is a **2021-2023 Ford F-150**, you just need to fix the relocation kit to the relocation bracket 1. (figure34)

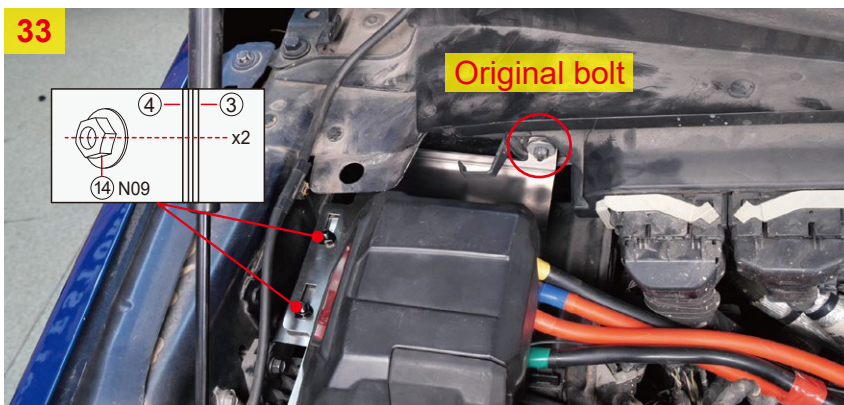

Step 18:

Thread the wires other than the anode wire connected to the power box from the engine compartment to the undercarriage. (figure35)

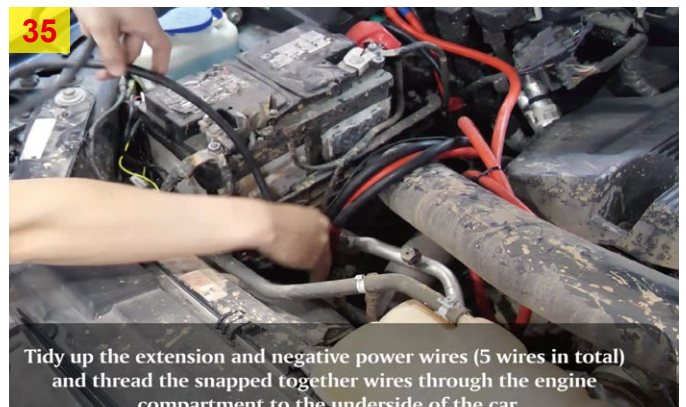

Step 19:

Remove seven four millimeter allen screws out, and clock the winch 90 degrees so that the handle is facing out the front of the vehicle and it's way easier to engage and disengage the clutch. (figure36~39)



Step 20:

The winch bracket has 2 rectangular holes for the forward direction of the winch cable as shown in Figure 40, and the winch is then secured to the winch bracket with 4 OEM bolts. (figure40~42)

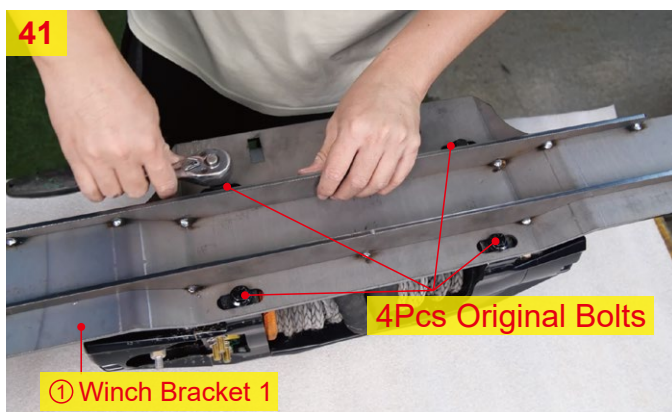
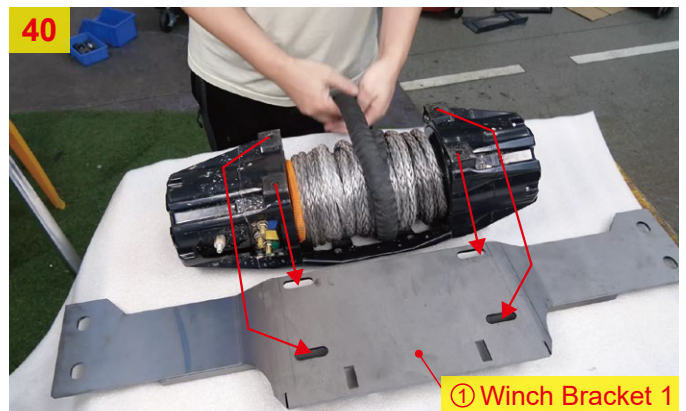

Step 21:

Move the winch bracket with the lift to the front of the vehicle's beam mounting position. (figure43)



Step 22:

Connect the colour-coded power extension cable to the winch screw post and cover with a waterproof rubber cap. (figure 44~47)

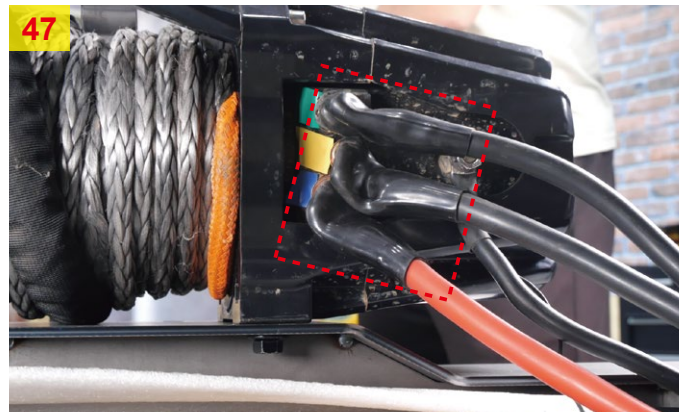
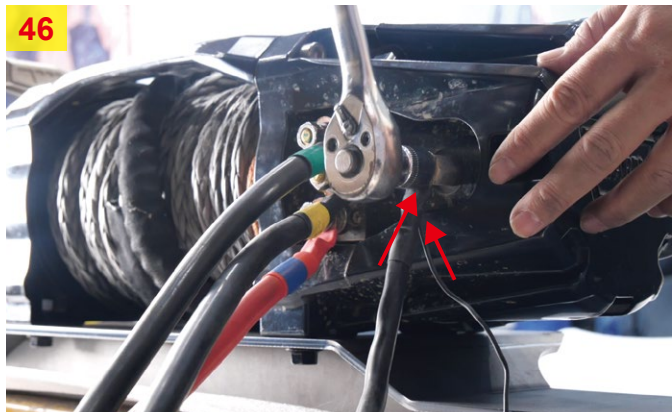
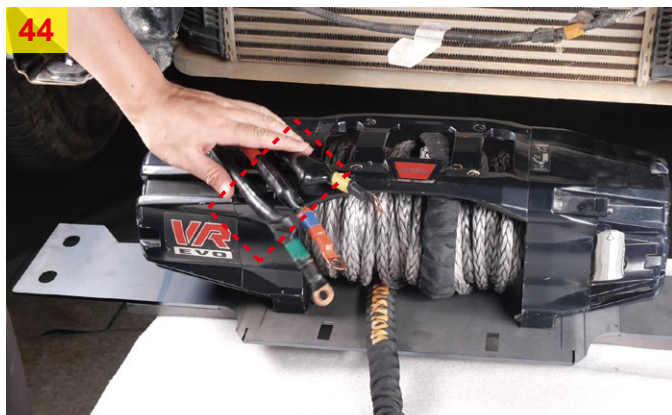

Step 23:

Remove the 2 bolts holding the factory trailer hitch in place. (figure 48)

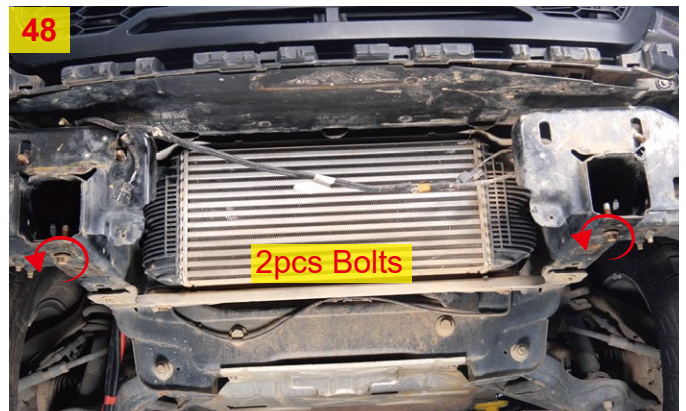

Step 24:

Move the winch bracket to the middle of the beam, align the screw holes in the bottom of the winch bracket with the holes for the trailer hitch bolts, and if you want to use the original trailer hitch again, tighten the bolts along with the winch bracket to the beam. (figure 49~52)

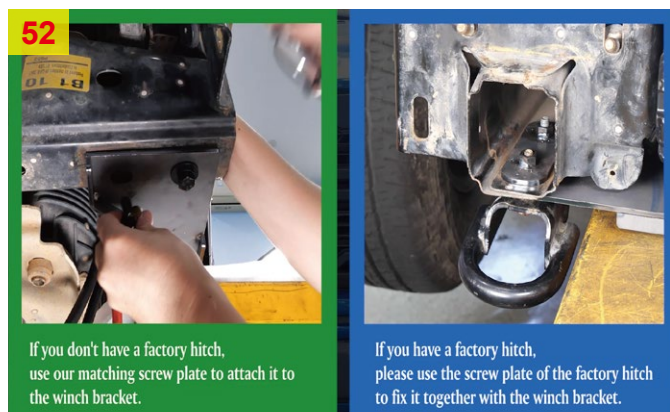
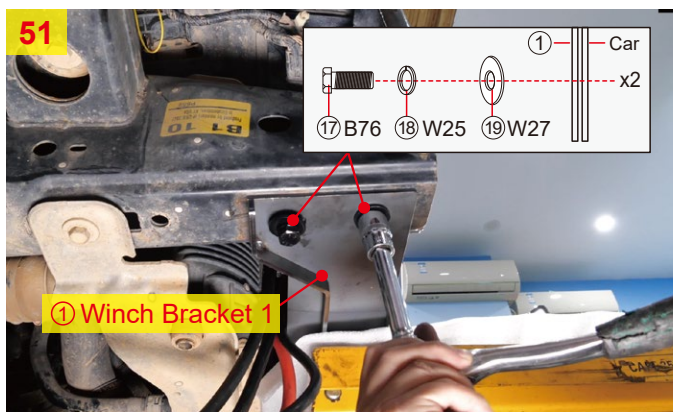

Step 25:

Use cable ties to tidy up and fix the power extension cable, and connect the cathode and anode power cables to the corresponding poles of the vehicle's power supply, and after completing the above work, insert the controller plug into the jack of the power control box and test whether the winch can work properly. (figure 53~56)

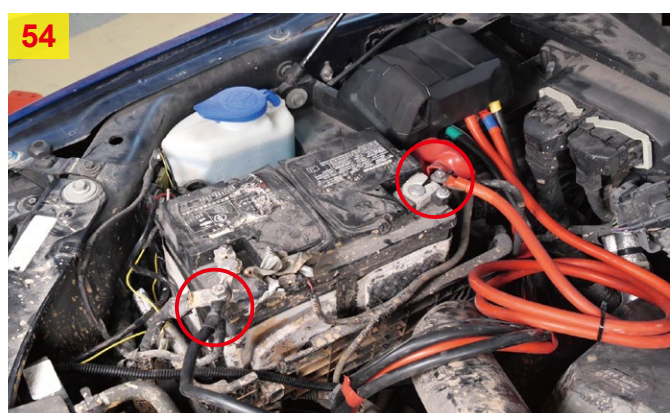
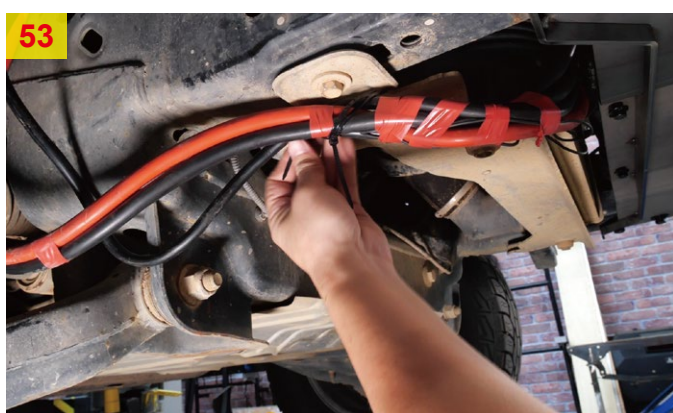



Note:

- ※ If you have purchased our front bumper, please ignore the following installation steps and follow our front bumper instructions step by step.
- ※ If you have not purchased our front bumper, please follow the steps below.

Step 26:

Attach the winch rope guide bracket to the winch bracket. (figure57~60)

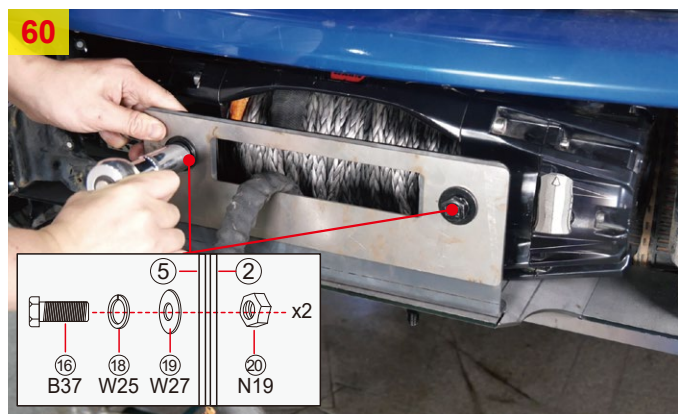
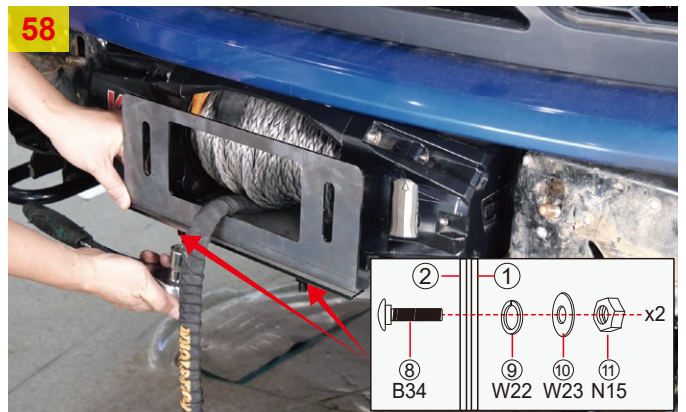
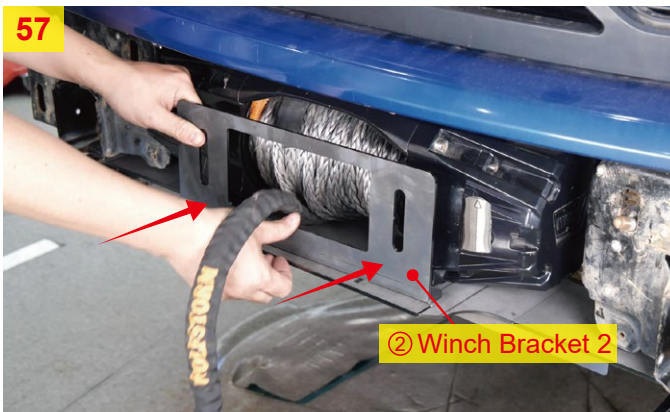

Step 27:

Remove the cover panel from the front bumper, then use a cutting tool to remove the licence plate fixing posts from the cover panel, then fit the panel back to the front bumper. (figure 61~67)

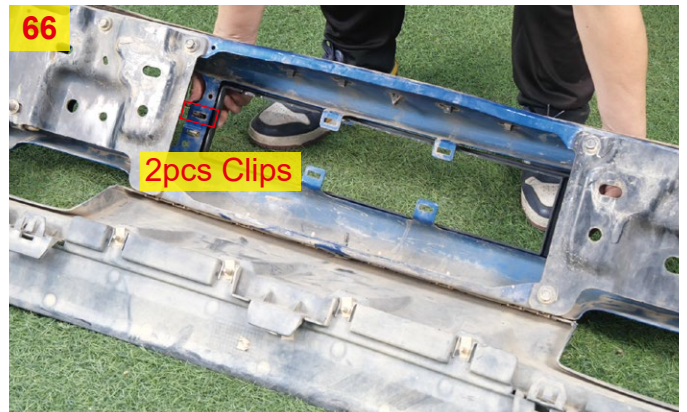
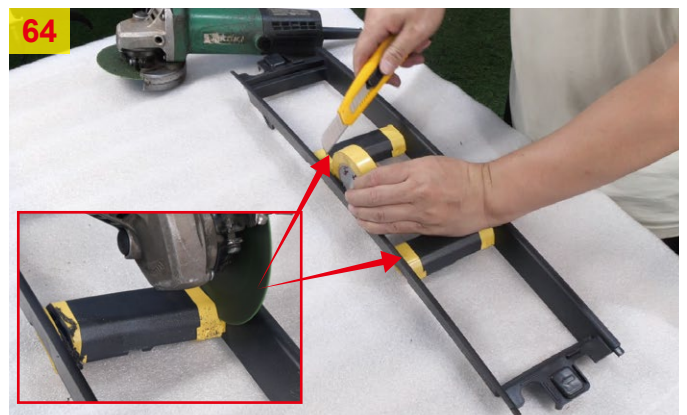
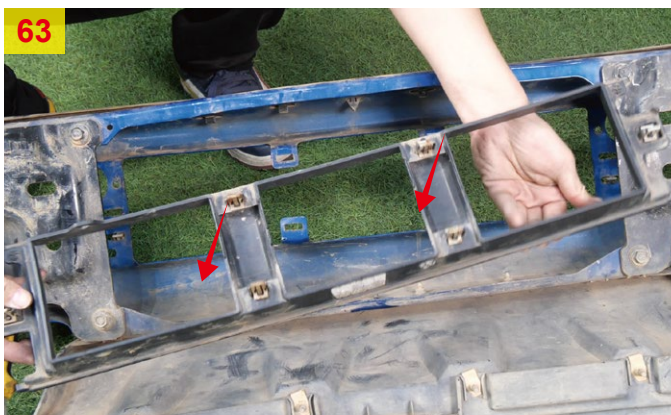
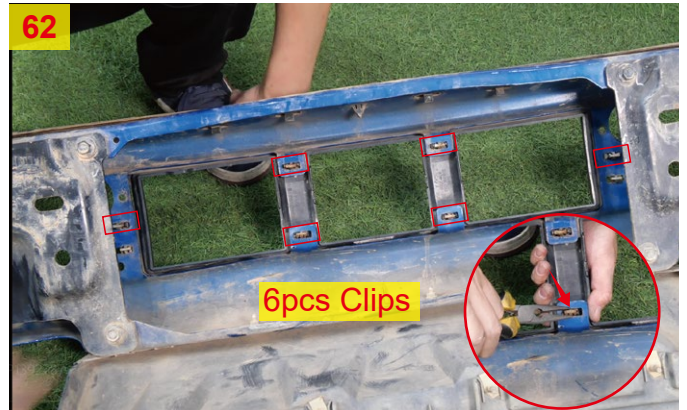
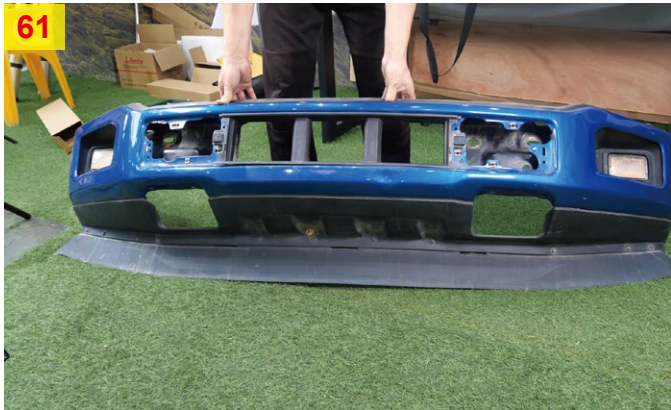

Step 28:

Reinstall the bumper back into the vehicle. Finally, fit the licence plate flipper and the rope guide to the rope guide bracket in that order. (figure 68~72)

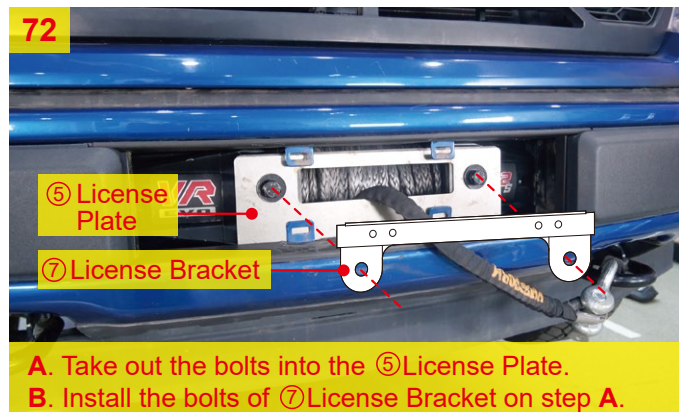
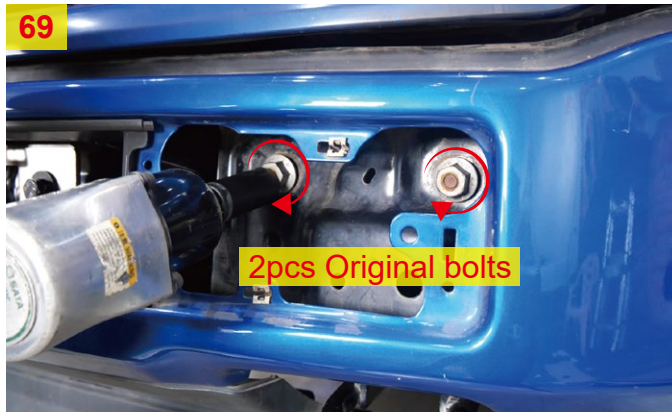
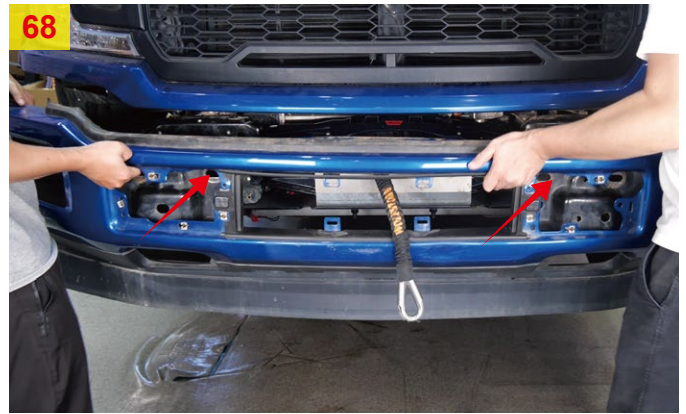

Original Front Bumper + Winch Plate

4000KG



Our Front Bumper (NF101A105) + Winch Plate

