

FRONT BUMPER

————— User Manual —————

2018-2022 Ford F-150



Model:	NF101A101
Material:	Q235A
Product Dimensions:	77.8 x 26.6 x 16.3 inch
Package Dimensions:	50 x 19.68 x 13.77 inch
Product Weight:	84.44 lbs

※Thank you for purchasing the FRONT BUMPER. Please read this manual carefully and keep it properly if you need to refer to it afterward. If you need any support or assistance, please contact us with your product model number and order number, and our support team will help you solve problems.

⚠ WARNING





※ This product is designed primarily to enhance the appearance of the vehicle. Do not rely in any way on the components of this product to protect against injury or death in the event of an accident. To reduce the risk of serious injury or property damage, please read all safety messages and understand all instructions and procedure notices before attempting to install or use this product.

⚠ CAUTION







※ Properly torque and recheck fasteners and security of step tread after 250 miles and inspect frequently. Do not use if damaged.



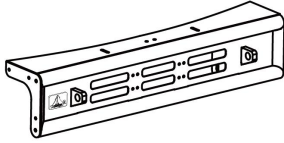

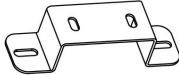
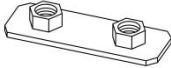

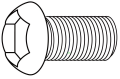
※ Bumpers are heavy and we strongly suggest seek assistants for lifting and installation of your bumper.

REQUIRED TOOLS

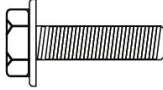
Socket 	Ratchet 	Wrench 	Allen Wrench 	Safety Glasses 
---	--	---	--	---

Parts Information

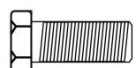
Parts NO.	Parts Name	Size	Line Graph	Qty	Color
/	Mid Bumper	/		1	Black
/	Left/Right Bumper	/		2	Black
/	Top Bumper	/		1	Black
/	License Bracket	/		2	Black
/	Nut Plates	/		2	Black
/	Bracket	/		2	Black
B06	Half Head Allen Bolts	M6x15		6	Dacro Black
W11	Flat Washer	Φ6x12x1.5		6	Dacro Black

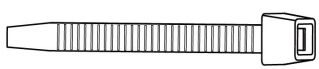
Parts NO.	Parts Name	Size	Line Graph	Qty	Color
N09	Hex Flange Nuts	M6		6	Dacro Black
B17	Hex Flange Bolts	M8x20		10	Dacro Black
W19	Flat Washer	Φ8x24x2		10	Dacro Black
N14	Hex Flange Nuts	M8		8	Dacro Black
B31	Hex Flange Bolts	M10x25		6	Dacro Black
W23	Flat Washer	Φ10x25x2		6	Dacro Black
W22	Spring Washer	Φ10		6	Dacro Black
N17	Hex Flange Nuts	M10		6	Dacro Black
B37	Hex Bolts	M12x35		6	Dacro Black
W27	Flat Washer	Φ12x30x3		6	Dacro Black
/	Ribbon	5x250		10	Black

***Note: spare parts such as B06、W11、N09、B17、W19、N14、B31、W23、W22、N17、B37、W27 are provided with 2PCS each (included in the number of parts details).**

Installation Instructions

Step 1: Open the carton and take out the parts. Check whether the number of components is complete.

Step 2: Remove the original front bumper and prepare the parts needed to install the front bumper basket.



Step 3: Splicing the mid bumper and left/right bumper, and tighten the bolts.

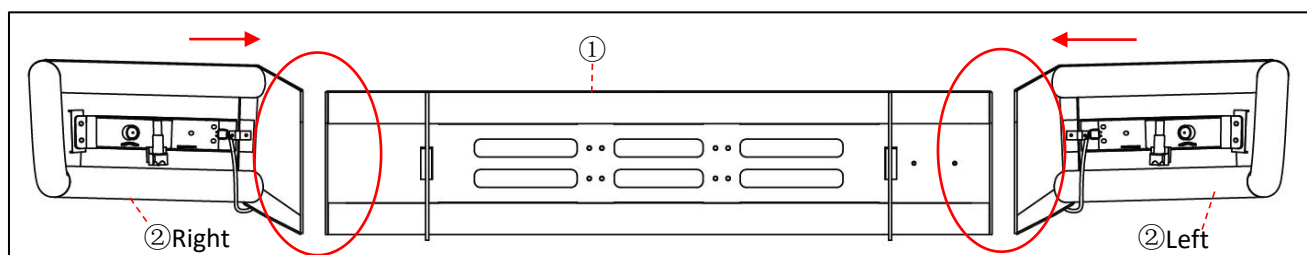
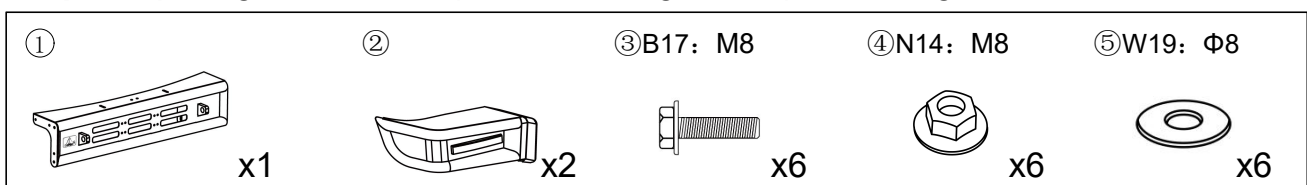

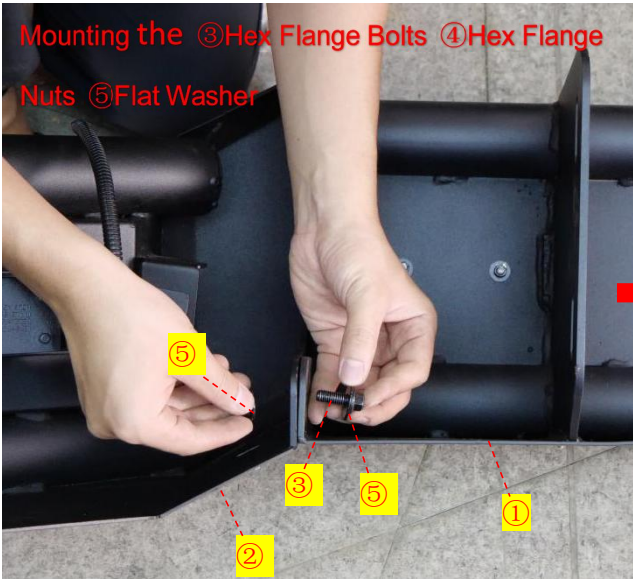
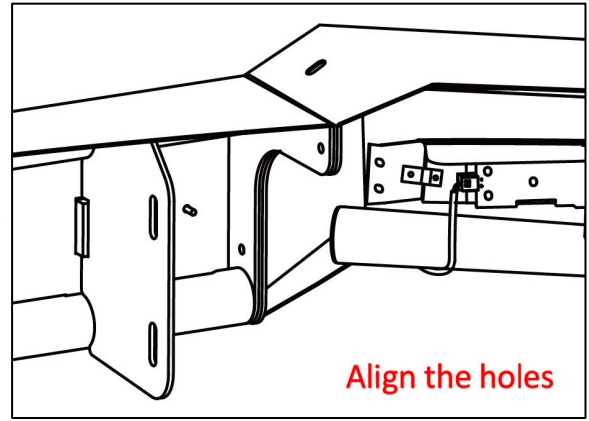
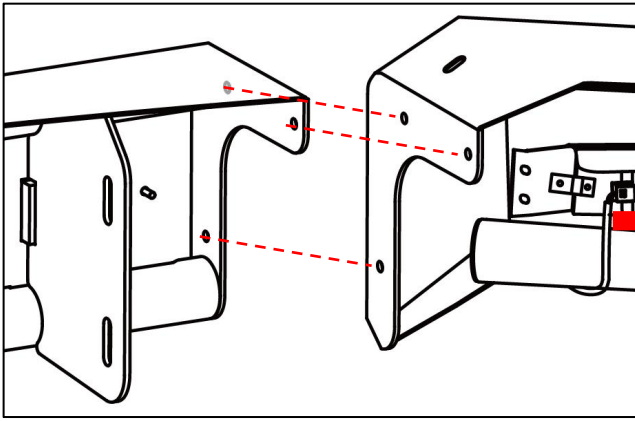

Step 4: Splicing the top bumper, and tighten the bolts.

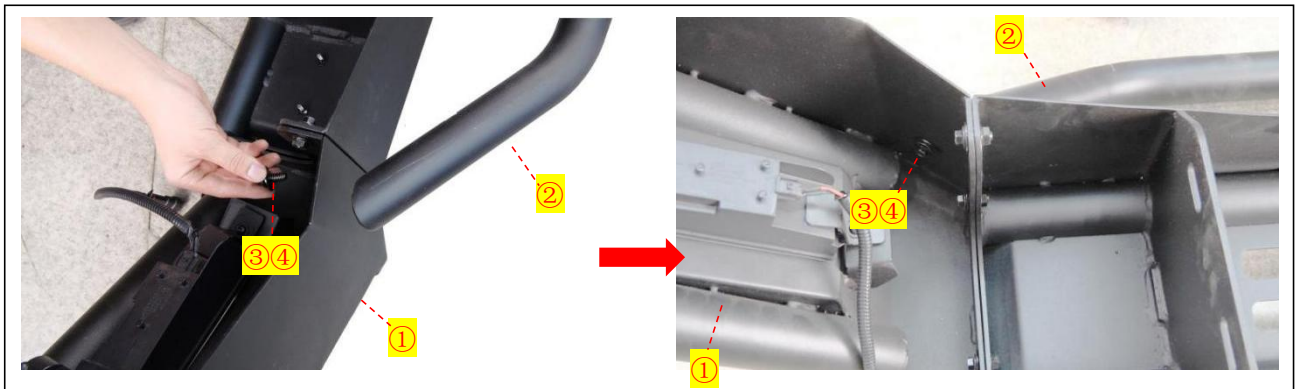
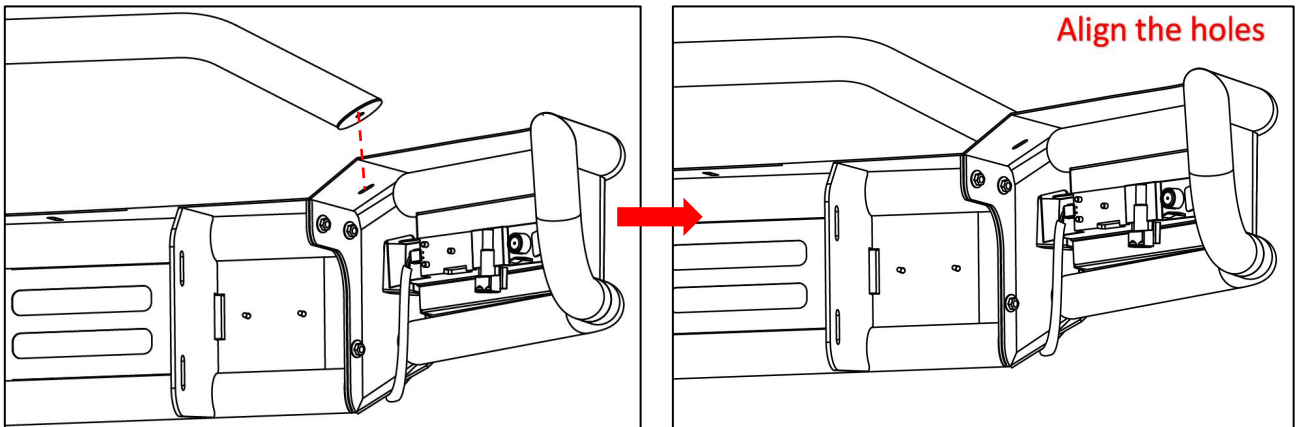
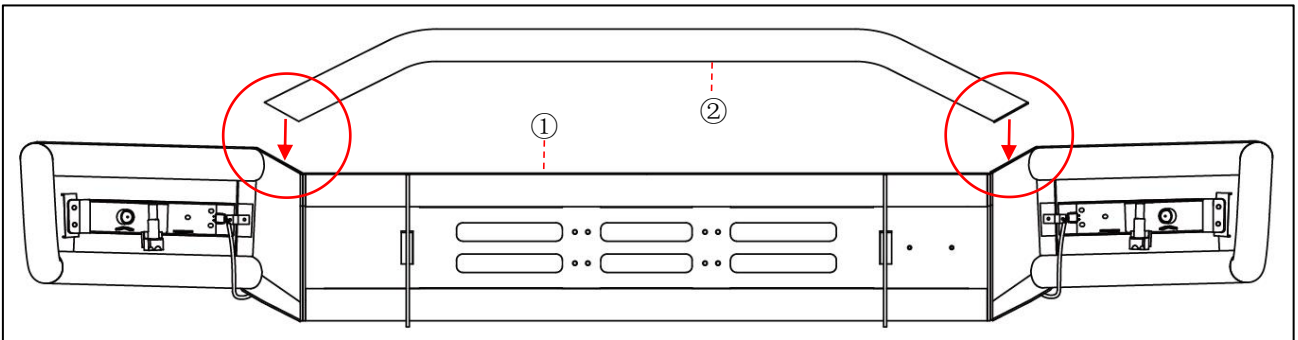
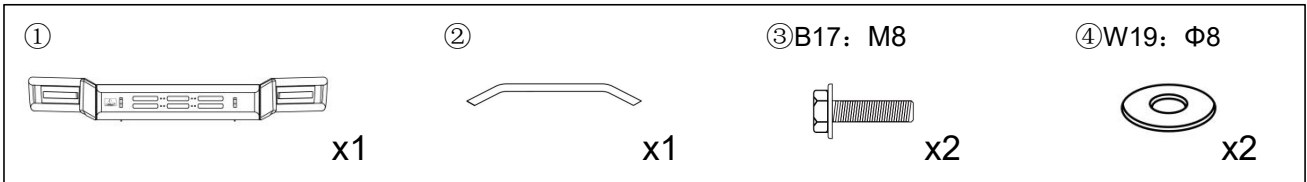

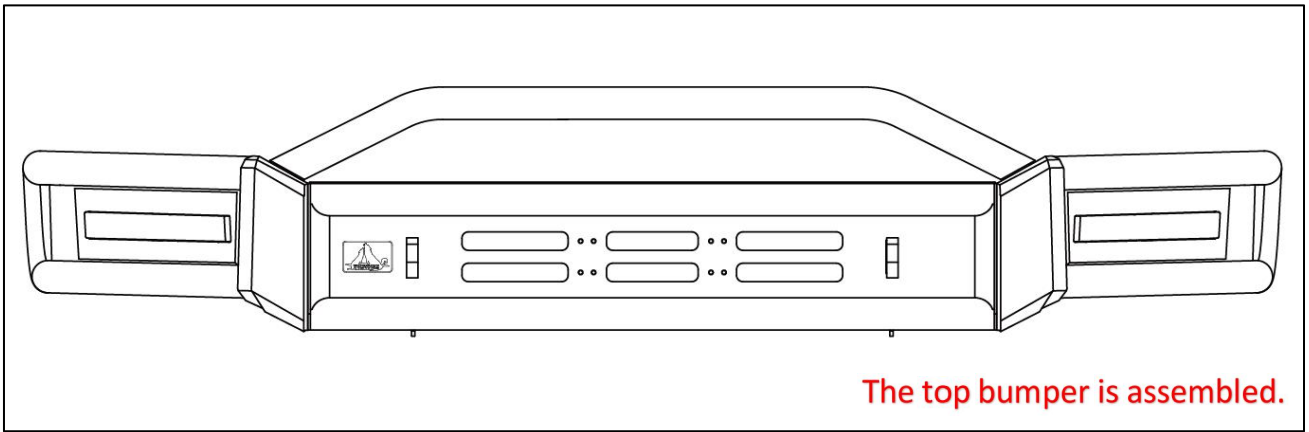

Step 5: Install the license bracket, and tighten the bolts.

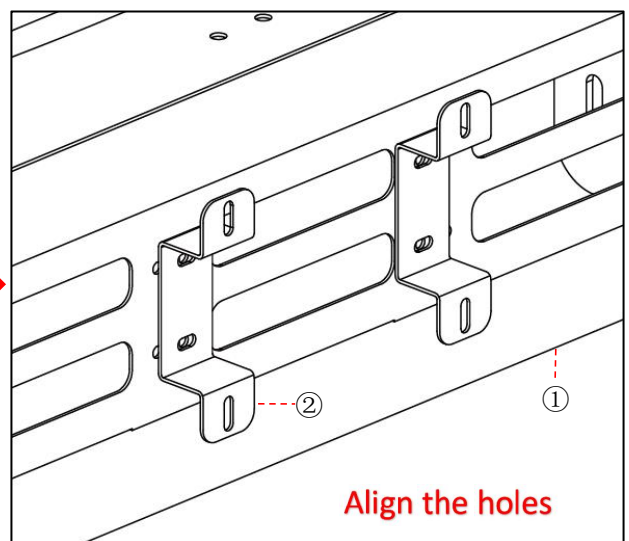
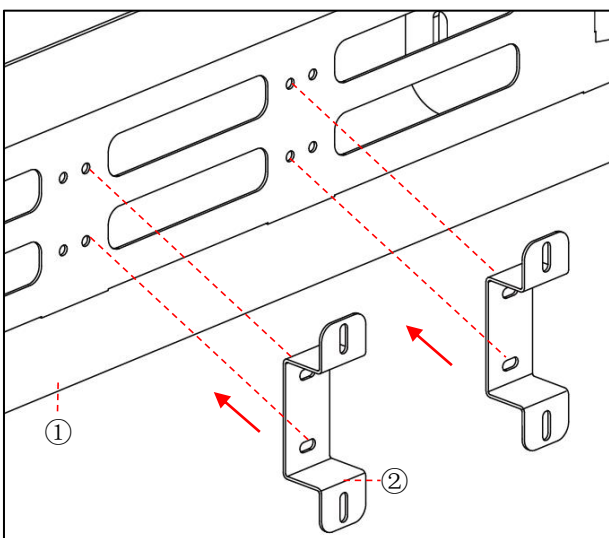
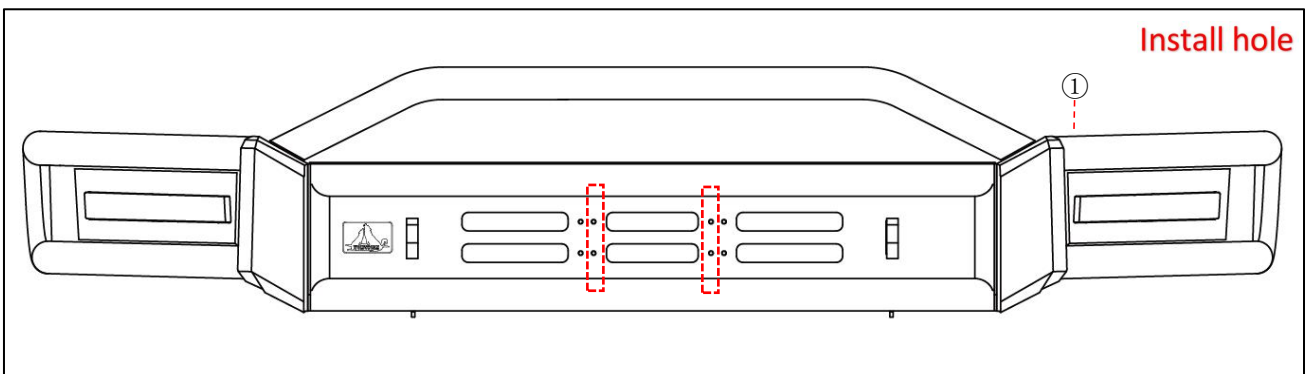
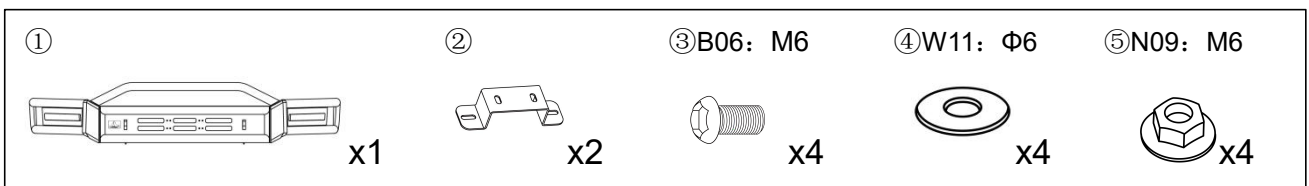

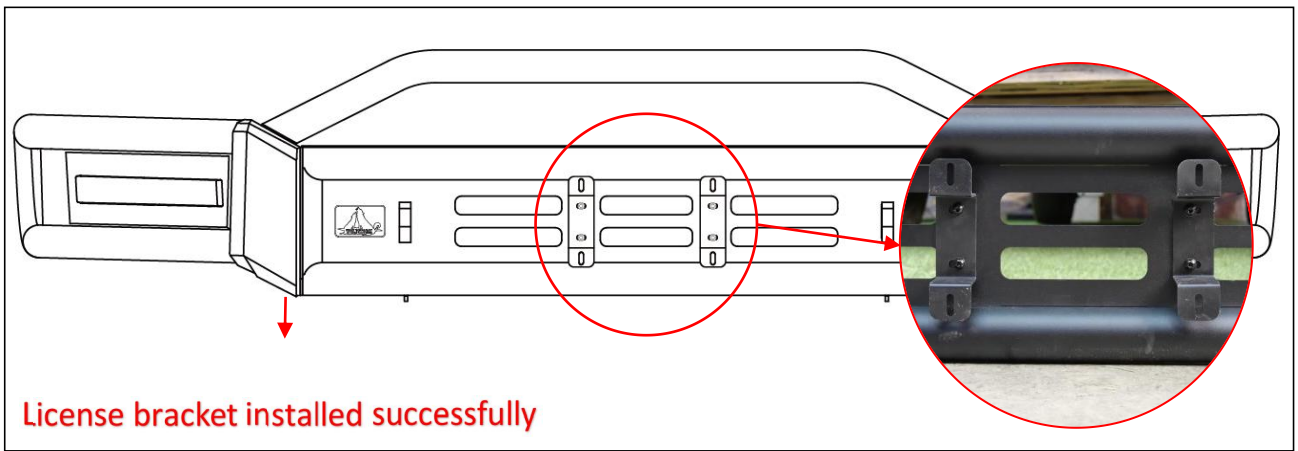
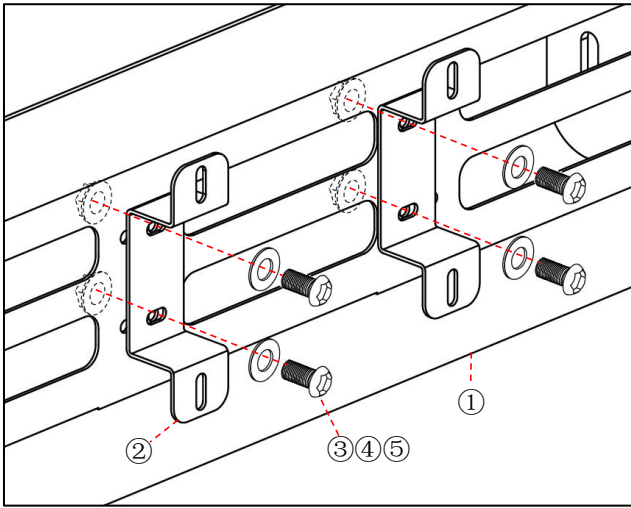

Step 6: Install the bracket, and tighten the bolts.

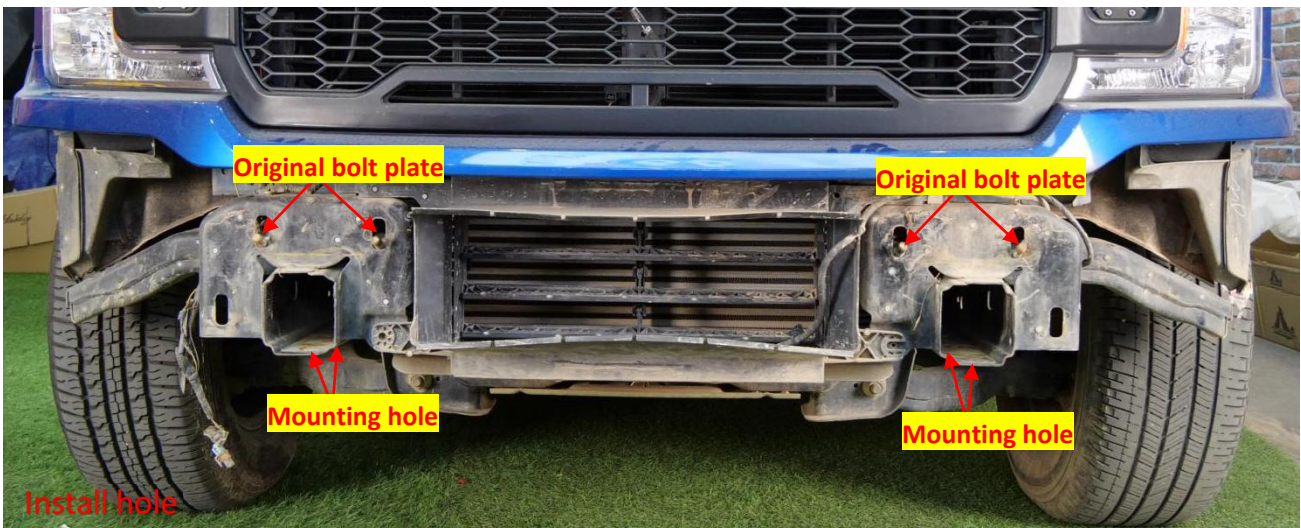
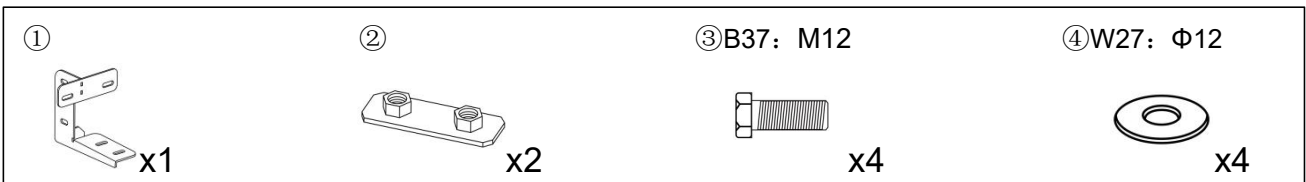

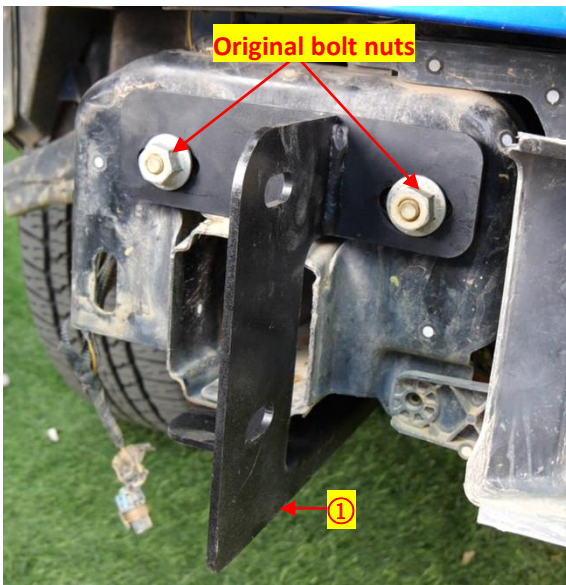
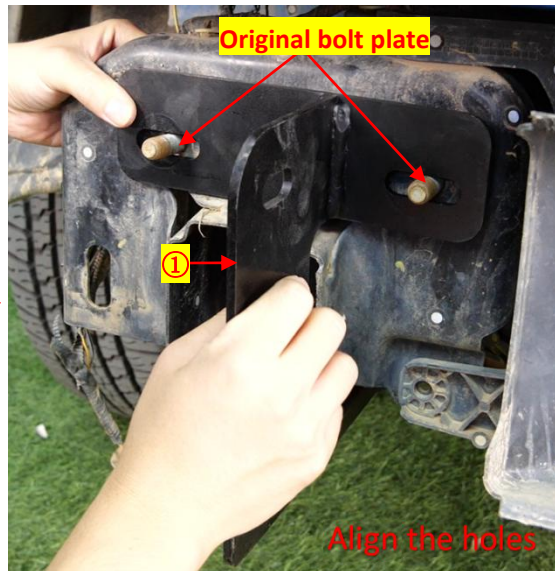
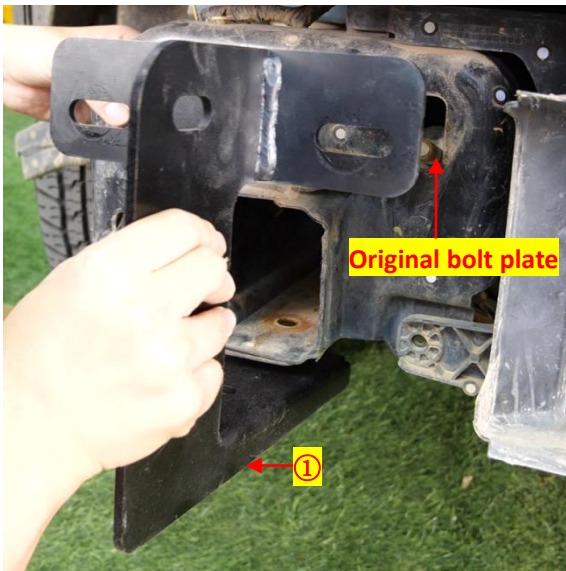

Note: Do not tighten the original bolt nuts in this step.

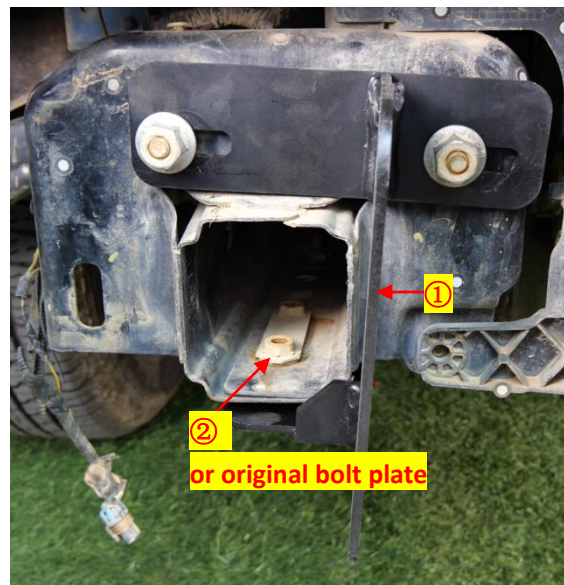
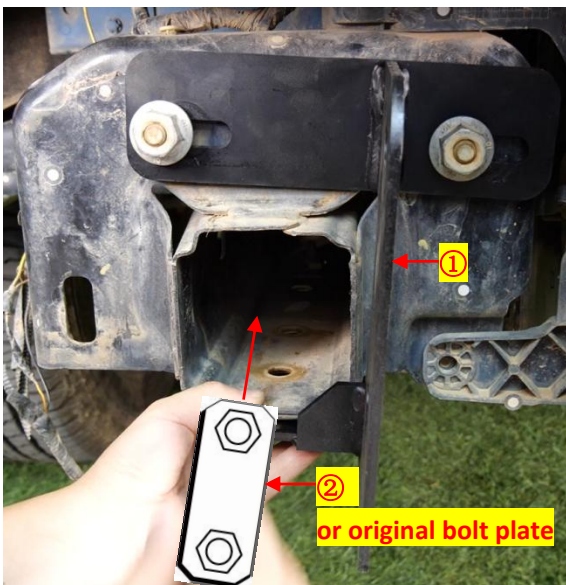

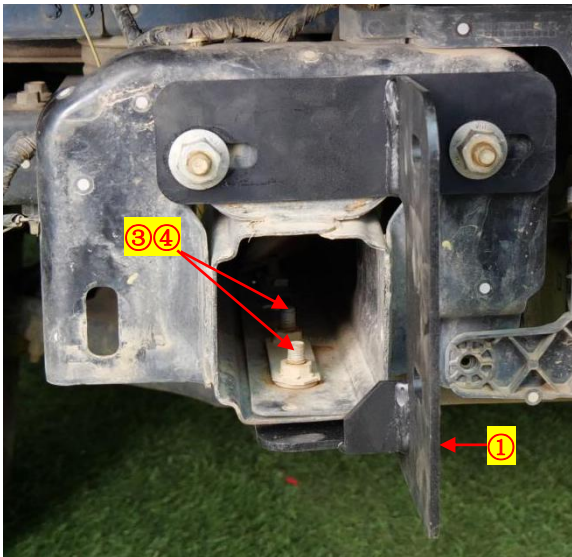





Note: Tighten all the bolts.

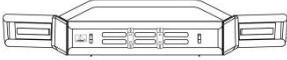

Step 7: Install the front bumper.

②	②B31: M10	③N17: M8	④W23: Φ10	⑤W19: Φ10
				
x1	x4	x4	x4	x4



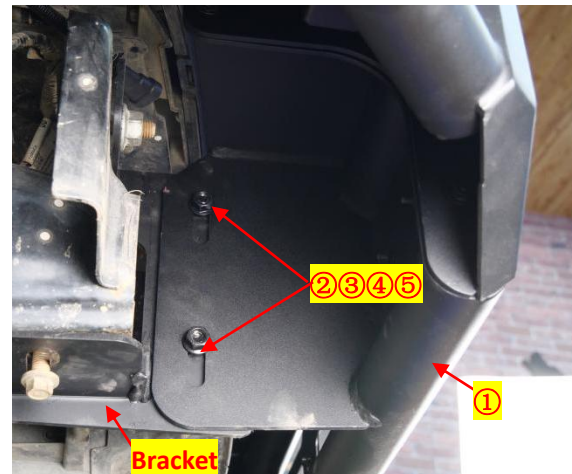
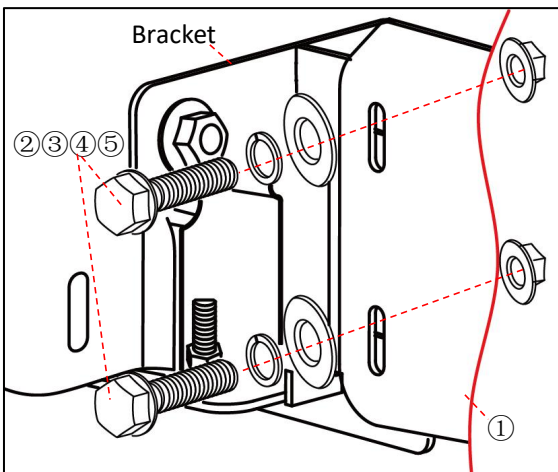
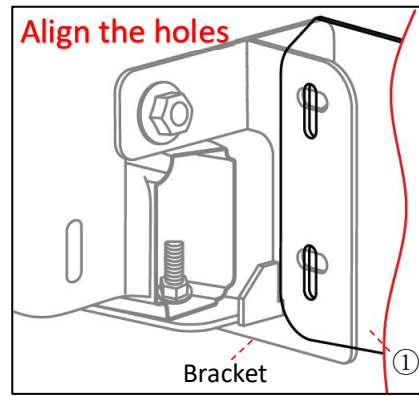
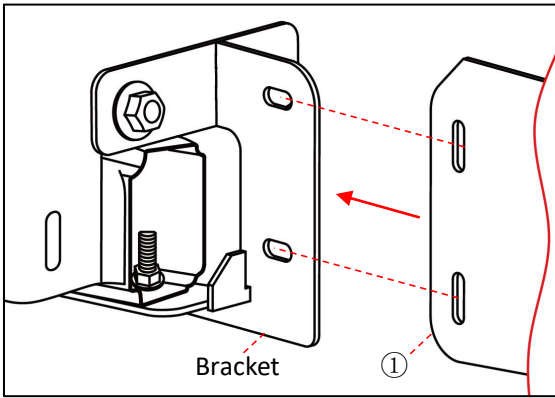

NOTICE: Do not tighten the screw in this step.

Step 8: Adjust the balance of the front bumper and the car side and tighten the bolts.



Step 9: Connect the fog light.
Plug the fog light plug to the original fog light plug.

