

OZARKÉ

INSTRUCTION MANUAL

OZARKÉ

ASSEMBLY INSTRUCTIONS

ASSEMBLY TIPS:

1. Simply remove the lamp from packaging.
2. Please check to see that all hardware and parts are present prior to start of assembly.
3. Please follow attached instructions in the same sequence as numbered to assure fast & easy assembly.

WARNING!



1. Don't attempt to repair or modify parts that are broken or defective. Please contact the store immediately
2. This product is for home use only and not intended for commercial establishments.

ASSEMBLY TIME

15 MINUTES

PARTS IDENTIFICATION

A LAMP BODY

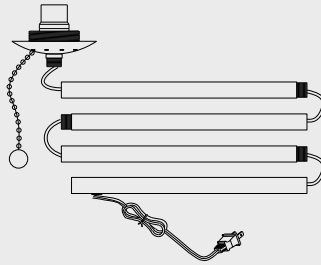

1PC

B GLASS SHADE

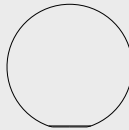

1PC

C LIGHT BULB



1PC

C LAMP BASE

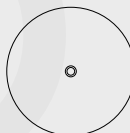

1PC

OZARKE

STEP 1

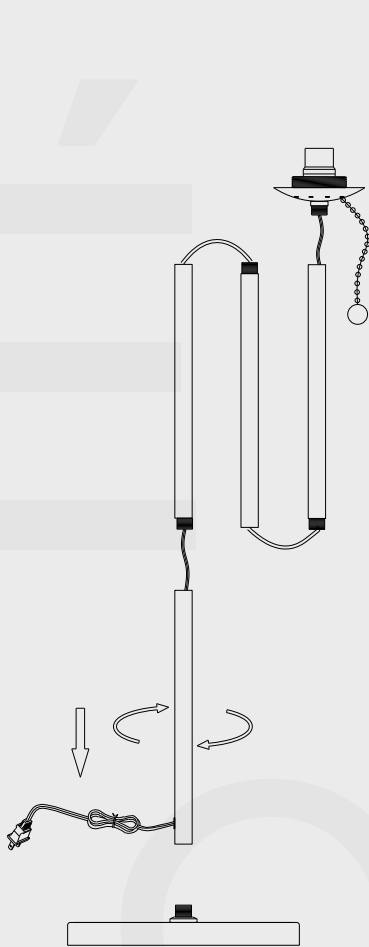

STEP 2

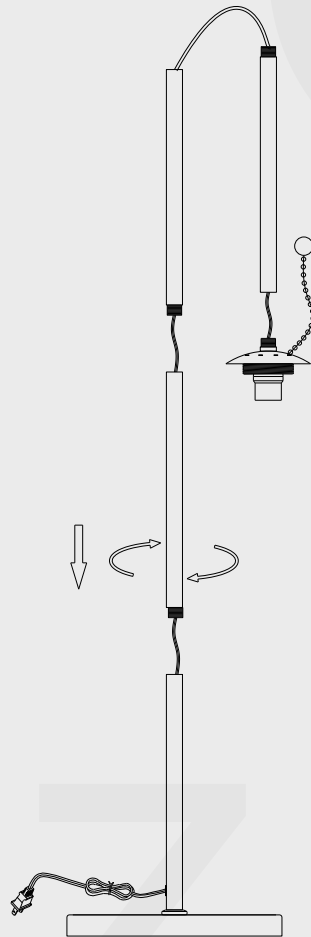

OZARKE

STEP3

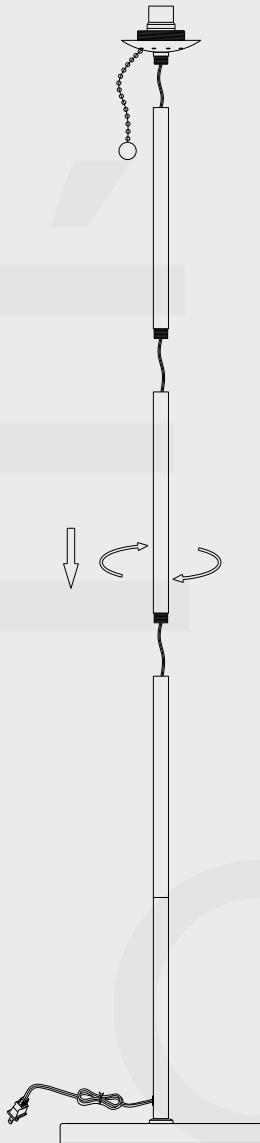

STEP4

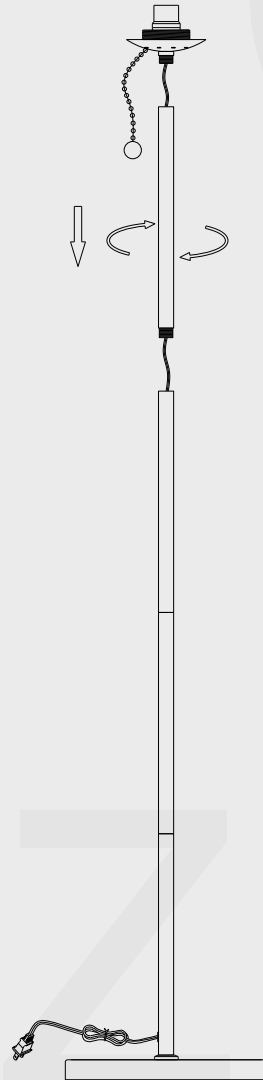

OZARKE

STEP5

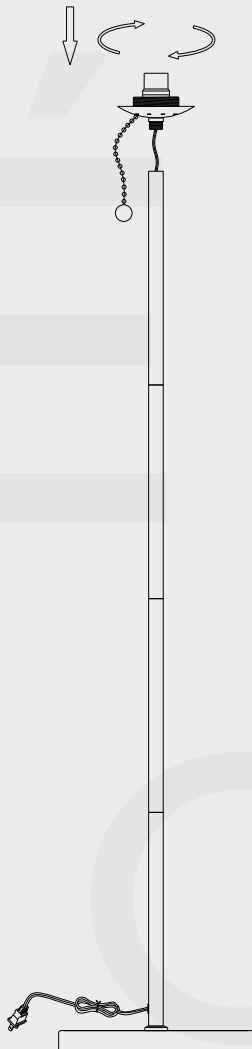

STEP6

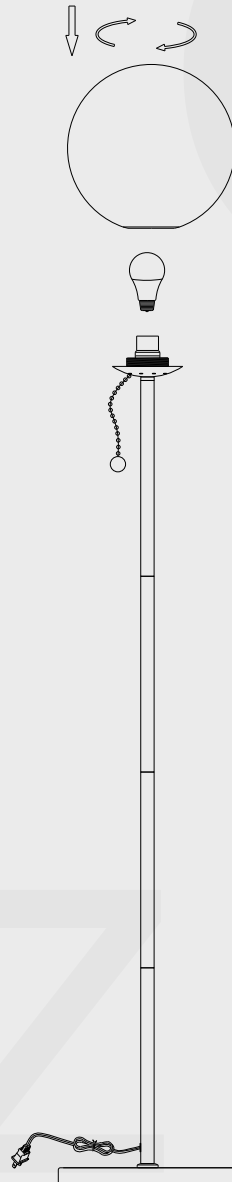

OZARKE

