



## Logitech Wireless Combo MK345



Setup Guide

English. . . . .	. 3
繁體中文 . . . . .	. 7
한국어 . . . . .	. 11

## Know your product

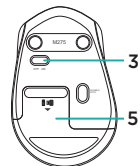
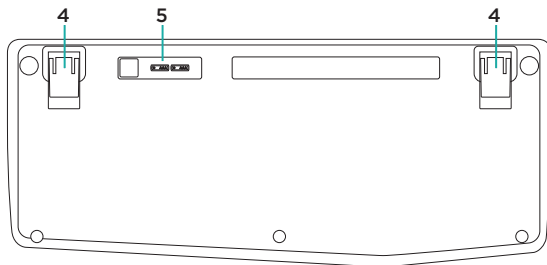
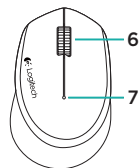
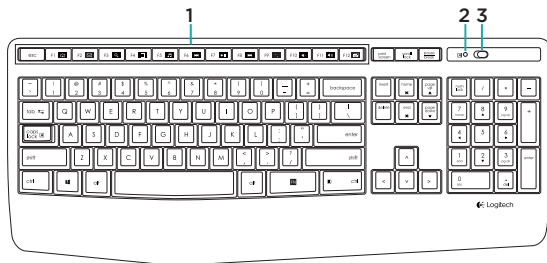

- |                        |                          |
|------------------------|--------------------------|
| 1. F-keys              | 6. Scroll wheel          |
| 2. Caps-lock LED       | 7. Battery indicator     |
| 3. On/off power switch | 8. Receiver              |
| 4. Tilt-legs           | 9. Product documentation |
| 5. Battery door        |                          |

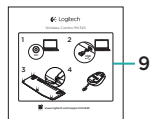

## Setting up your keyboard and mouse

1

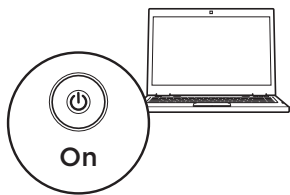

2

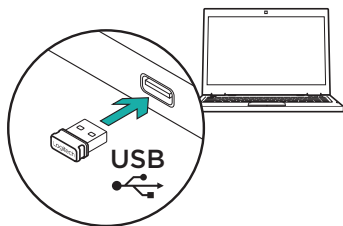

3

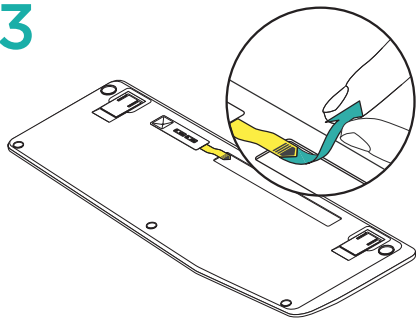

4

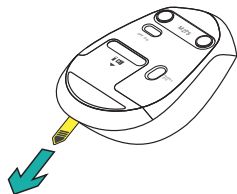

## Keyboard F-keys

User friendly enhanced F-keys let you launch applications easily. To use the enhanced functions, first press and hold the **FN** key, then press the F-key you want to use.

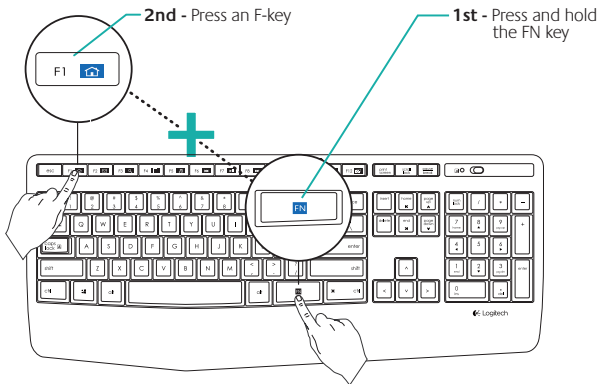

**FN** + **F1** = Launch Web browser

**FN** + **F2** = Launch Email application

**FN** + **F3** = Search

**FN** + **F4** = Launch calculator

**FN** + **F5** = Launch media player

**FN** + **F6** = Previous track

**FN** + **F7** = Play/pause track

**FN** + **F8** = Next track

**FN** + **F9** = Mute

**FN** + **F10** = Volume down

**FN** + **F11** = Volume up

**FN** + **F12** = Print screen

**Tip:** You can use the Logitech SetPoint™ software to reprogram **F1**, **F2**, and **F4** with your preferred features

## Visit Product Support

There's more information and support online for your product. Take a moment to visit Product Support to learn more about your new keyboard and mouse.

Browse online articles for setup help, usage tips, or information about additional features. If your keyboard has optional software, learn about its benefits and how it can help you customize your product.

Connect with other users in our Community Forums to get advice, ask questions, and share solutions.

At Product Support, you'll find a wide selection of content:

- Tutorials
- Troubleshooting
- Support community
- Software downloads
- Online documentation
- Warranty information
- Spare parts (when available)

Go to [www.logitech.com/support/mk345](http://www.logitech.com/support/mk345)

## Troubleshooting

### Keyboard and mouse not working

- Check your keyboard and mouse are powered on.
- Check that the receiver is securely plugged into a USB port on your computer.
- If the receiver is plugged into a USB hub, try plugging it directly into your computer.
- Try plugging the receiver into a different USB port closer to your keyboard and mouse.
- Remove any metallic objects between the receiver and your keyboard and mouse.
- Check that you pulled the battery tab out of your keyboard and mouse.
- Check the orientation of the batteries. The mouse uses one AA alkaline battery and the keyboard uses two AAA alkaline batteries.

## 認識產品

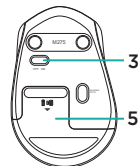
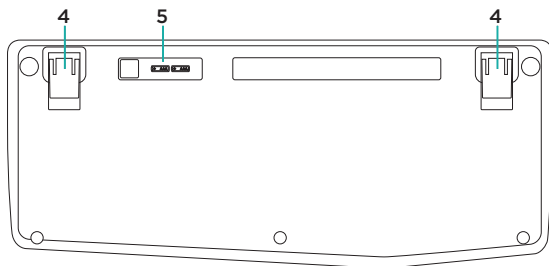
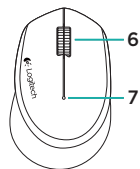
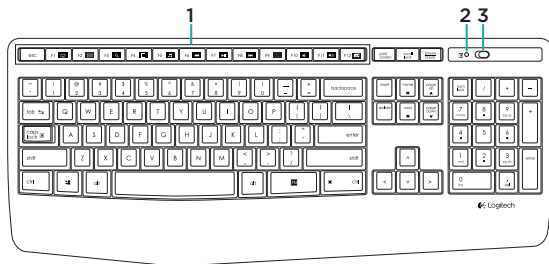

- |                      |            |
|----------------------|------------|
| 1. F 功能鍵             | 6. 滾輪      |
| 2. Caps-lock LED 指示燈 | 7. 電池狀態指示燈 |
| 3. 開啟/關閉電源開關         | 8. 接收器     |
| 4. 傾斜支腳              | 9. 產品文件    |
| 5. 電池蓋               |            |

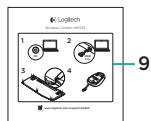

## 設定鍵盤與滑鼠

1

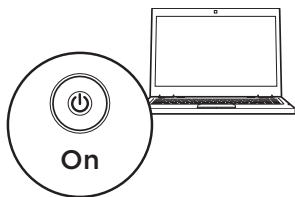

2

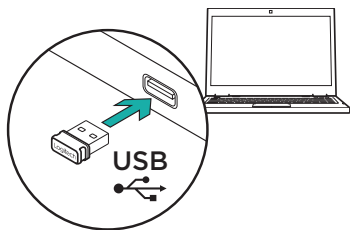

3

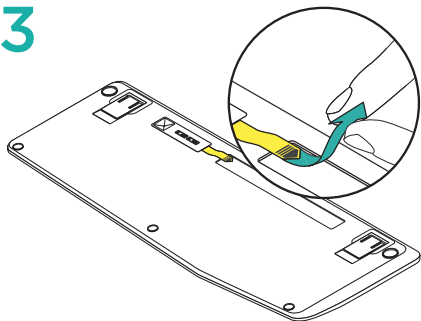

4

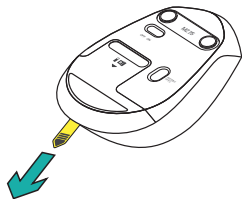



## 鍵盤 F 功能鍵

方便使用的加強 F 功能鍵，便於讓您啟動應用程式。若要使用增強功能，請按住 **FN** 鍵，然後按下要使用的 F 功能鍵。

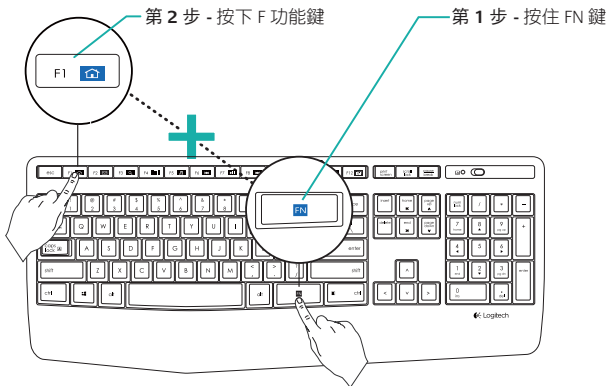

**FN** + **F1** = 啟動網頁瀏覽器

**FN** + **F2** = 啟動電子郵件應用程式

**FN** + **F3** = 搜尋

**FN** + **F4** = 啟動小算盤程式

**FN** + **F5** = 啟動媒體播放器

**FN** + **F6** = 上一首

**FN** + **F7** = 播放/暫停曲目

**FN** + **F8** = 下一首

**FN** + **F9** = 靜音

**FN** + **F10** = 音量減小

**FN** + **F11** = 音量增大

**FN** + **F12** = 列印螢幕

提醒：您可以使用羅技 SetPoint™ 軟體將 **F1**、**F2** 與 **F4** 鍵重新自訂為您偏好使用的功能

## 造訪「產品支援」頁面

您的產品在網路上還有更多的相關資訊與支援。請抽空造訪「產品支援」頁面，深入瞭解您的新鍵盤與滑鼠。

請瀏覽線上文章，瞭解設定說明、使用秘訣，或是其他功能的相關資訊。如果您的鍵盤隨附選用軟體，您可以深入瞭解軟體優點及該軟體如何協助您自訂產品。

您還可以和「社群論壇」中的其他使用者保持聯繫以獲得建議、提出問題，以及分享解決方案。

「產品支援」頁面提供各式各樣的精采內容：

- 教學課程
- 疑難排解
- 支援社群
- 軟體下載
- 線上文件
- 保固資訊
- 備用零件 (如有提供時)

請瀏覽 [www.logitech.com/support/mk345](http://www.logitech.com/support/mk345)

## 疑難排解

### 鍵盤和滑鼠無法正常運作

- 檢查您的鍵盤與滑鼠是否已開啟電源。
- 檢查接收器是否穩固地插入電腦上的 USB 連接埠。
- 若將接收器插入 USB 集線器，請嘗試將其直接插入電腦。
- 嘗試將接收器插入到較接近鍵盤與滑鼠的不同 USB 連接埠上。
- 將接收器與鍵盤和滑鼠之間的任何金屬物品移走。
- 檢查是否已將鍵盤和滑鼠的電池標籤貼紙拉出。
- 檢查電池的方向。滑鼠使用一個 3 號 AA 鹼性電池，鍵盤使用兩個 4 號 AAA 鹼性電池。

## 제품 설명

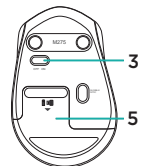
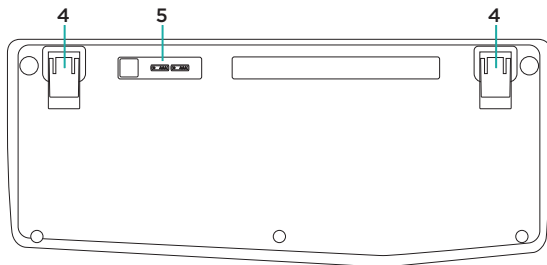
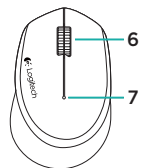
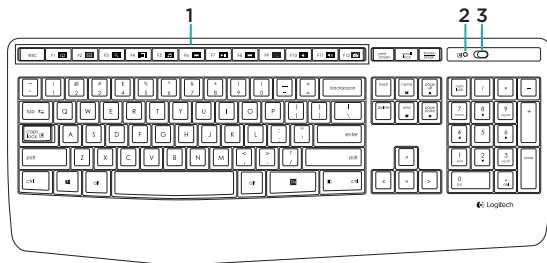

1. F 키
2. Caps Lock LED
3. 전원 켜기/끄기 스위치
4. 키보드 다리
5. 배터리 덮개

6. 스크롤 휠
7. 배터리 표시기
8. 수신기
9. 제품 설명서

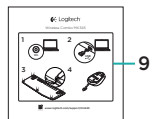

## 키보드 및 마우스 설정

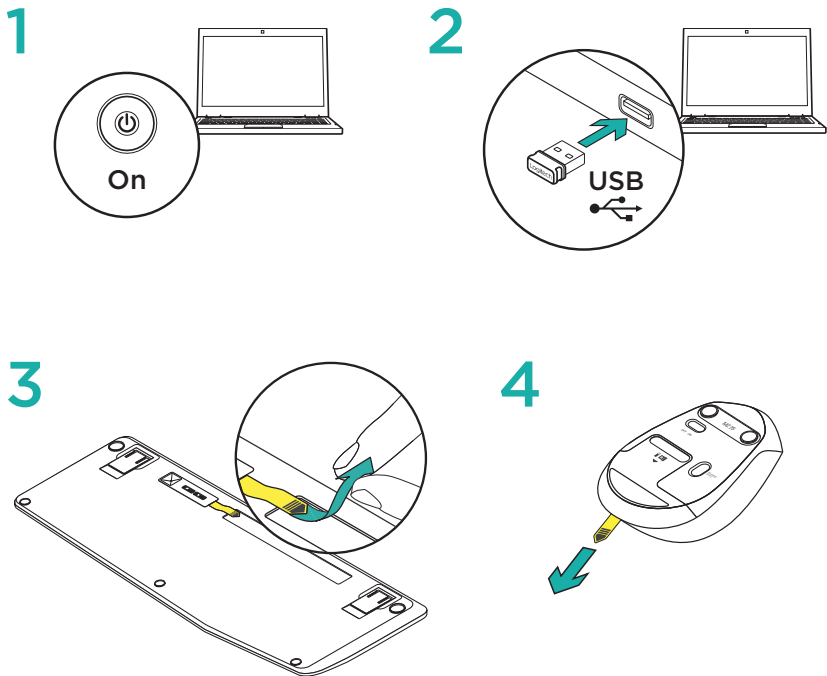

## 키보드 F 키

사용하기 간편한 항상된 F 키를 사용하여 응용 프로그램을 쉽게 실행할 수 있습니다. 고급 기능을 사용하려면 **FN** 키를 누른 상태로, 사용하려는 F 키를 누릅니다.

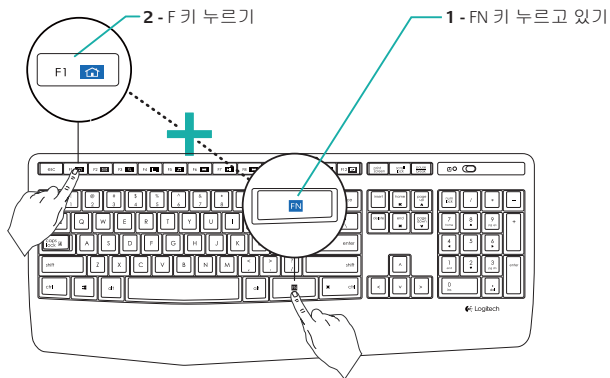

**FN** + **F1** = 웹 브라우저 실행

**FN** + **F2** = 이메일 응용 프로그램 실행

**FN** + **F3** = 검색

**FN** + **F4** = 계산기 실행

**FN** + **F5** = 미디어 플레이어 실행

**FN** + **F6** = 이전 트랙

**FN** + **F7** = 트랙 재생/일시 정지

**FN** + **F8** = 다음 트랙

**FN** + **F9** = 음소거

**FN** + **F10** = 볼륨 줄이기

**FN** + **F11** = 볼륨 높이기

**FN** + **F12** = 화면 인쇄

**참:** Logitech SetPoint™ 소프트웨어를 사용하여 원하는 기능으로 **F1**, **F2** 및 **F4**를 다시 프로그래밍할 수 있습니다.

## 제품 지원 방문

온라인상에서 제품에 대한 추가 정보와 지원을 확인할 수 있습니다. 제품 지원에는 새로운 키보드와 마우스에 관한 자세한 내용이 나와 있습니다.

설정 도움말, 사용 팁 또는 추가 기능에 관한 정보를 온라인으로 찾아 볼 수 있습니다. 사용 중인 키보드에 옵션 소프트웨어가 있는 경우, 해당 소프트웨어의 이점과 소프트웨어를 사용한 제품 커스터마이징 방법을 알아 보십시오.

Community Forums에서 다른 사용자들과 교류하면서 질문과 조언을 교환하고 솔루션을 공유할 수 있습니다.

제품 지원에서는 다음과 같은 폭넓은 내용을 선택할 수 있습니다.

- 사용 지침
- 문제 해결
- 지원 커뮤니티
- 소프트웨어 다운로드
- 온라인 문서
- 보증 정보
- 예비 부품(해당되는 경우)

참조: [www.logitech.com/support/mk345](http://www.logitech.com/support/mk345)

## 문제 해결

### 키보드 및 마우스가 작동하지 않음

- 키보드 및 마우스가 켜져 있는지 확인하십시오.
- 수신기가 컴퓨터의 USB 포트에 안정적으로 연결되어 있는지 확인하십시오.
- 수신기가 USB 허브에 연결되어 있는 경우 컴퓨터에 직접 연결해 보십시오.
- 수신기를 키보드 및 마우스와 더 가까운 다른 USB 포트에 연결해 보십시오.
- 수신기 및 키보드와 마우스 사이에 있는 금속 물체를 제거하십시오.
- 키보드와 마우스의 배터리 탭을 당겼는지 확인하십시오.
- 배터리 방향을 점검하십시오. 마우스는 AA 알카라인 배터리 한 개, 키보드는 AAA 알카라인 배터리 두 개가 필요합니다.





[www.logitech.com](http://www.logitech.com)

[www.logitech.com/support/mk345](http://www.logitech.com/support/mk345)

© 2014 Logitech. All rights reserved. Logitech, the Logitech logo, and other Logitech marks are owned by Logitech and may be registered. All other trademarks are the property of their respective owners. Logitech assumes no responsibility for any errors that may appear in this manual. Information contained herein is subject to change without notice.

621-000369.002