

# K375s MULTI-DEVICE

Setup Guide | 设置指南 | 設定指南 | 설치 가이드

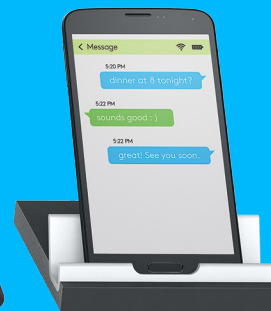

logitech®

- 3 ENGLISH
- 10 简体中文
- 18 繁體中文
- 25 한국어

# K375s MULTI-DEVICE AT A GLANCE

- 1 Easy-Switch keys with three channels
- 2 Separate smartphone/tablet stand
- 3 Dual-printed layout: Windows®/Android™ and Mac OS/iOS
- 4 Tilt legs for adjustable angle
- 5 Battery door
- 6 Dual connectivity: Unifying receiver and Bluetooth® Smart

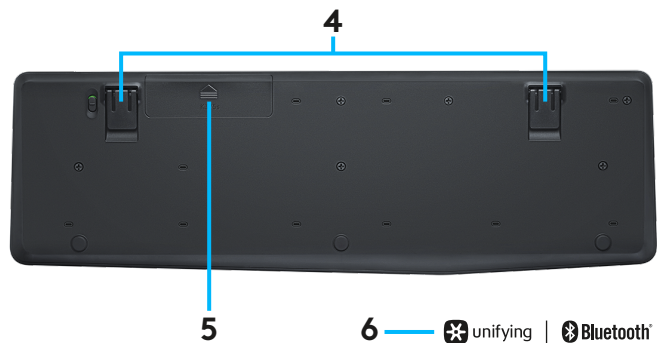
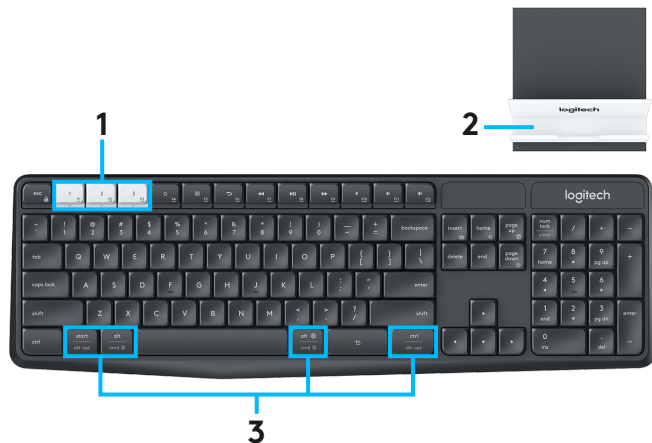

# GET CONNECTED

The K375s Multi-Device wireless keyboard and stand allows you to connect up to three devices either via *Bluetooth* Smart or via the included pre-paired Unifying USB receiver.

## Quick Setup

Follow these steps to easily connect to your computer, laptop, or tablet. For more information on how to connect with Unifying or *Bluetooth* Smart, go to the following sections.

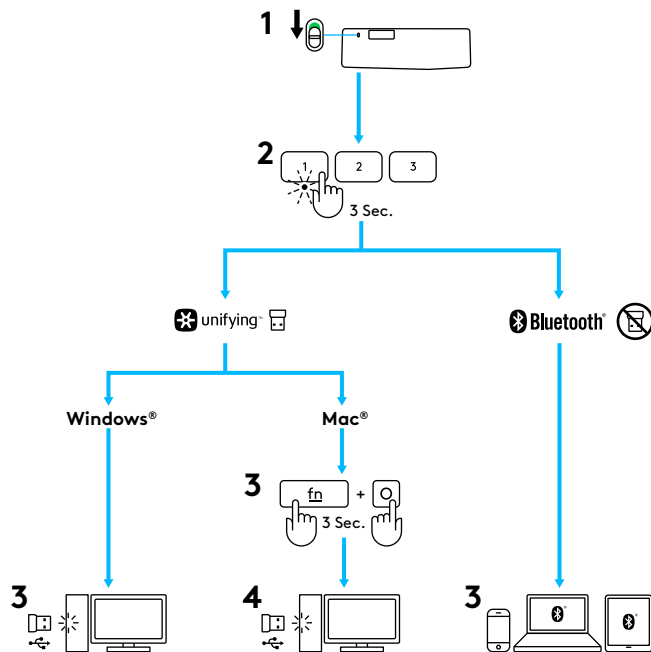

# CONNECT WITH UNIFYING

The K375s Multi-Device keyboard comes with a pre-paired receiver that provides a plug-and-play connection to your computer or laptop. If you want to pair a second time to the receiver in the box or pair to an existing Unifying receiver, follow these steps.

## Requirements

- USB port
- Unifying software
- Windows® 10 or later, Windows® 8, Windows® 7
- Mac OS X 10.10 or later
- Chrome OS™

## How to connect

- 1 Download Unifying software. You can download the software at [www.logitech.com/unifying](http://www.logitech.com/unifying).
- 2 Make sure your keyboard is turned on.
- 3 Press and hold one of the white Easy-Switch keys for three seconds. (The LED on the selected channel will blink rapidly.)
- 4 Configure your keyboard according to your operating system:
  - **For Mac OS/iOS:**  
Press and hold **fn + o** for three seconds. (The LED on selected channel will light up.)
  - **For Windows, Chrome, or Android:**  
Press and hold **fn + p** for three seconds (The LED on selected channel will light up.)
- 5 Plug in the Unifying receiver.
- 6 Open the Unifying software and follow the instructions on the screen.

## CONNECT WITH *BLUETOOTH SMART*

The K375s Multi-Device keyboard allows you to connect via *Bluetooth Smart*. Please ensure your device is *Bluetooth Smart* ready and runs one of the following operating systems:

### Requirements

- Windows® 10 or later, Windows® 8
- Android™ 5.0 or later
- Mac OS X 10.10 or later
- iOS 5 or later
- Chrome OS™

### How to connect



- 1 Make sure your K375s Multi-Device is turned on and *Bluetooth* is enabled on your computer, tablet, or phone.
- 2 Press and hold one of the white Easy-Switch keys for three seconds. (The LED on the selected channel will blink rapidly.)
- 3 Open *Bluetooth* settings on your device and pair with “Keyboard K375s.”
- 4 Type the on-screen password and press enter or return.

# ENHANCED FUNCTIONS

The K375s Multi-Device has a number of enhanced functions to get even more out of your new keyboard. The following enhanced functions and shortcuts are available.

## Hot keys and media keys







The table below shows hot keys and media keys available for Windows, Mac OS, Android, and iOS.

									
Windows 10	Task view	Contextual menu	Back in browser	Previous track	Play/pause	Next track	Mute	Volume down	Volume up
Windows 8 Windows 7	Browser home page	Contextual menu	Back in browser	Previous track	Play/pause	Next track	Mute	Volume down	Volume up
Android	Home	Menu	Back	Previous track	Play/pause	Next track	Mute	Volume down	Volume up
iOS	Home	Show/hide virtual keyboard	Home	Previous track	Play/pause	Next track	Mute	Volume down	Volume up
Mac OS	Mission Control	Dashboard/launchpad*	Back in browser*	Previous track	Play/pause	Next track	Mute	Volume down	Volume up

\*Requires installation of Logitech Options software

## Fn shortcuts

To perform a shortcut, hold down the **fn** (function) key while pressing the key associated with an action. The table below shows function key combinations for the different operating systems.

						
Windows 10	Lock F-functions	F-function	Print screen	Cortana search	Calculator	Switch language
Windows 8 Windows 7	Lock F-functions	F-function	Print screen	Search	Calculator	Switch language
Android	Lock F-functions	—	Print screen	Search	—	—
iOS	Lock F-functions	—	Screenshot	Search	—	Switch language
Mac OS	Lock F-functions	F-function	Print screen	Spotlight in Finder	—	Switch language



# DUAL LAYOUT

Unique dual-printed keys make the K375s Multi-Device compatible across different operating systems (e.g. Mac OS, iOS, Windows, Chrome OS, Android). Key label colors and split lines identify functions or symbols reserved for different operating systems.

## Key label color

Grey labels indicate functions valid on Apple devices running Mac OS or iOS.



White labels on grey circles identify symbols reserved for Alt GR on Windows computers.



## Split keys

Modifier keys on either side of the space bar display two sets of labels separated by split lines. The label above the split line shows the modifier sent to a Windows or Android device.

The label below the split line shows the modifier sent to an Apple computer, iPhone, or iPad. The keyboard automatically uses modifiers associated with the currently selected device.



## How to configure your keyboard

To configure the layout according to your operating system you need to press one of the following shortcuts for three seconds. (The LED on selected channel will light up to confirm when the layout has been configured.)

iOS: **fn + i**



Mac OS: **fn + o**



Windows: **fn + p**



If you connect via *Bluetooth* Smart this step is not necessary as OS detection will configure it automatically.

## K375s 多设备键盘一览

- 1 “易于切换”按键，带三条信道
- 2 独立智能手机/平板电脑支架
- 3 双排标识键盘布局： Windows®/Android™ 和 Mac OS/iOS
- 4 可调角度式倾斜支架
- 5 电池盖
- 6 双重连接技术： Unifying™ 优联接收器和蓝牙™ 智能

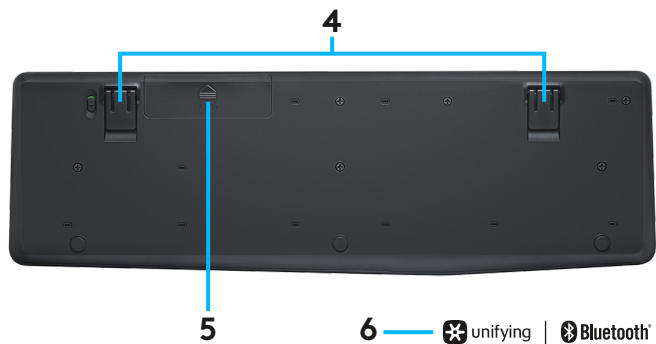
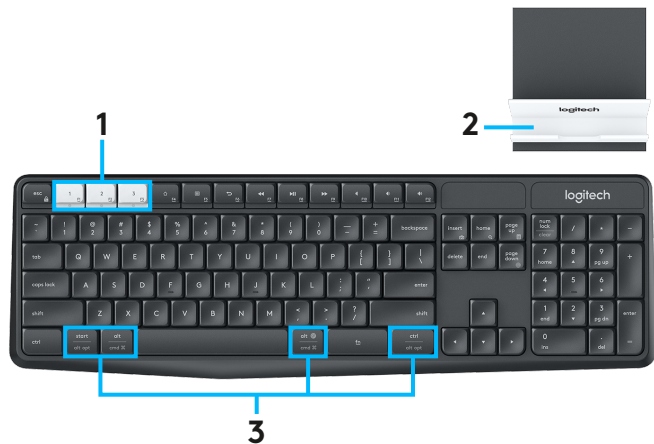

# 连接

借助蓝牙智能或预配对的 Unifying™ 优联 USB 接收器, K375s 多设备无线键盘和支架最多可连接三个设备。

## 快速安装

按照以下步骤快速连接至电脑、笔记本电脑或平板电脑。  
有关连接到 Unifying™ 优联或蓝牙智能的详细信息, 请参阅以下部分。

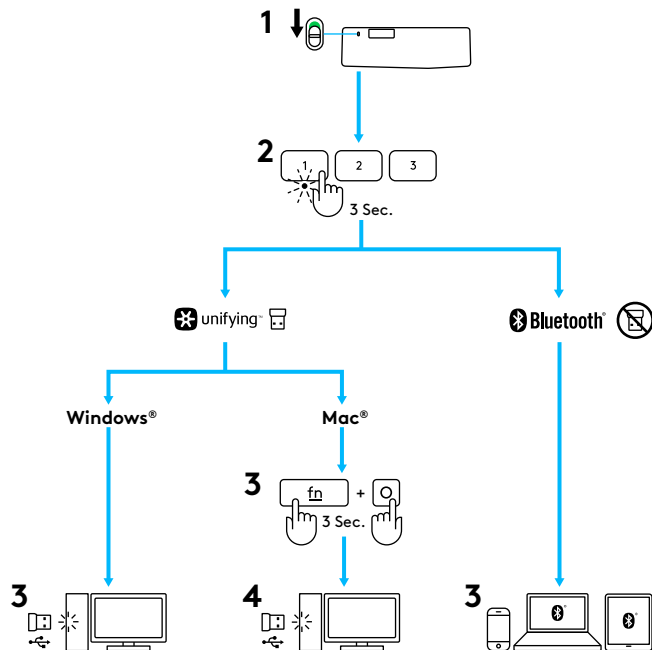

## 使用 UNIFYING™ 优联连接

K375s 多设备键盘随附提供预配对的接收器,可直接连接到您的计算机或笔记本上,即插即用。如要对盒中的接收器进行二次配对,或者要与已有的 Unifying™ 优联接收器配对,请按以下步骤操作。

### 要求

- USB 端口
- Unifying™ 优联软件
- Windows® 10 或更高版本、Windows® 8、Windows® 7
- Mac OS X® 10.10 或更高版本
- Chrome OS™

### 连接说明

- 1 下载 Unifying™ 优联软件。  
可在 [www.logitech.com/unifying](http://www.logitech.com/unifying) 下载软件。
- 2 确保键盘处于开启状态。
- 3 按住其中一个白色“易于切换”按键 3 秒钟。(所选通道的 LED 指示灯会快速闪烁。)
- 4 按照具体操作系统对键盘进行配置:
  - **对于 Mac OS /iOS:**  
按住 **fn + o** 并保持三秒钟  
(所选通道的 LED 指示灯会点亮。)
  - **对于 Windows、Chrome 或 Android:**  
按住 **fn + p** 并保持三秒钟  
(所选通道的 LED 将亮起)
- 5 插入 Unifying™ 优联接收器。
- 6 打开 Unifying™ 优联软件,按照屏幕上的说明进行操作。

## 通过蓝牙智能连接

K375s 多设备键盘支持通过蓝牙智能进行连接。请确保您设备的蓝牙智能已就绪且采用以下操作系统之一：

### 要求

- Windows® 10 或更高版本, Windows® 8
- Android™ 5.0 或更高版本
- Mac OS X 10.10 或更高版本
- iOS 5 或更高版本
- Chrome OS™

### 连接说明

- 1 请确保 K375s 多设备键盘已经打开, 并且您的电脑、平板电脑或智能手机已经启用蓝牙。
- 2 按住其中一个白色“易于切换”按键 3 秒钟。(所选通道的 LED 指示灯会快速闪烁。)
- 3 打开设备上的蓝牙设置, 然后将其与“K375s 键盘”配对。
- 4 在屏幕上键入密码并按下“确认”或“返回”。

## 增强功能

K375s 多设备键盘具有多种增强功能, 让您的新键盘能够发挥出更多作用。支持以下增强功能和快捷键。

### 热键和媒体键







下表列出了 Windows®、Mac OS、Android™ 和 iOS 可用的热键和媒体键。

									
Windows® 10	任务视图	上下文相关的菜单	在浏览器中后退	上一曲目	播放/暂停	下一曲目	静音	调低音量	调高音量
Windows® 8 Windows® 7	浏览器主页	上下文相关的菜单	在浏览器中后退	上一曲目	播放/暂停	下一曲目	静音	调低音量	调高音量
Android™	主页	菜单	后退	上一曲目	播放/暂停	下一曲目	静音	调低音量	调高音量
iOS	主页	显示/隐藏虚拟键盘	主页	上一曲目	播放/暂停	下一曲目	静音	调低音量	调高音量
Mac OS	任务控制	Dashboard/ launchpad*	返回浏览器*	上一曲目	播放/暂停	下一曲目	静音	调低音量	调高音量

\*需要安装 Logitech Options 软件

## Fn 快捷键

Fn 要执行快捷操作, 请按住 **fn** (功能) 键, 同时按下与动作相关的键。下表显示了不同操作系统的功能键组合。

						
Windows 10	锁定 F 功能键	F 功能键	全屏截图	Cortana 搜索	计算器	切换语言
Windows 8 Windows 7	锁定 F 功能键	F 功能键	全屏截图	搜索	计算器	切换语言
Android	锁定 F 功能键	—	全屏截图	搜索	—	—
iOS	锁定 F 功能键	—	屏幕截图	搜索	—	切换语言
Mac OS	锁定 F 功能键	F 功能键	全屏截图	在 Finder 中聚焦	—	切换语言

# 双重布局

借助特有的双排标识按键，K375s 多设备键盘可兼容多种不同的操作系统（例如，Mac OS、iOS、Windows、Chrome OS、Android）。按键标记颜色和分割线，可识别为不同操作系统预留的功能或符号。

## 按键标签颜色

灰色标记适用于采用 Mac OS 或 iOS 的 Apple 设备。



带灰色圆圈和白色标签的符号为预留符号，适用于 Windows 计算机上的 Alt GR。



## 共用按键

空格键左右两侧的各修改键都显示两套标记，由分割线隔开。分割线上方的标记面向 Windows 或 Android 设备。

分割线下方的标记面向 Apple 计算机、iPhone 或 iPad。键盘能够根据当前所选设备自动选取相应的辅助键。



## 键盘的配置

要按照具体操作系统进行键盘布局配置，须按住以下快捷键之一并保持三秒钟。（所选通道的 LED 将点亮，以确认键盘布局已经配置完毕。）

iOS: **fn + i**



Mac OS : **fn + o**



Windows: **fn + p**



如使用蓝牙智能进行连接，则无需执行此步骤，因为操作系统识别技术将进行自动配置。



# 产品中有害物质的名称及含量

根据中国<< 电子电气产品有害物质限制使用标识要求>>

有害物质 Hazardous Substances						
部件名称 Parts Name	铅 (Pb)	汞 (Hg)	镉 (Cd)	六价铬 (Cr(VI))	多溴联苯 (PBB)	多溴二苯醚 (PBDE)
电缆线/电源 Cable/Adaptor	X	O	O	O	O	O
电路板组件 PWAs	X	O	O	O	O	O
塑料/其它部件 Plastic/Others parts	O	O	O	O	O	O
玻璃部件 Glass parts	X	O	O	O	O	O
金属部件 Metal parts	X	O	O	O	O	O
电池 Battery	X	O	O	O	O	O

本表格依据 SJ/T 11364 的规定编制。

O = 表示该有害物质在该部件所有均质材料中的含量均在 GB/T 26572 规定的限量要求以下。

X = 表示该有害物质至少在该部件的某一均质材料中的含量超出 GB/T 26572 规定的限量要求。

表中标有 " X " 的所有部件均符合欧盟 RoHS Recast 法规 - 2011/65/EU 指令。

此表显示"罗技科技有限公司"的电子电气产品部件中何处存在这些有害物质。请注意，并非内装产品都包含上述所有部件。

注：环保使用期限的参考标准，取决于产品正常工作的温度和湿度等条件。



## K375s 多工鍵盤概覽

- 1 具有三個頻道的 Easy-Switch 按鍵
- 2 獨立的智慧型手機/平板電腦支架
- 3 兩種標示鍵盤配置：Windows®/Android™ 與 Mac OS /iOS
- 4 用於調整角度的傾斜支架
- 5 電池蓋
- 6 雙重連線技術：Unifying 接收器與 Bluetooth® Smart

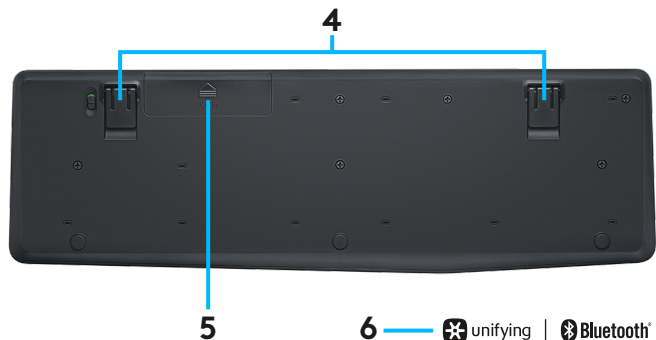
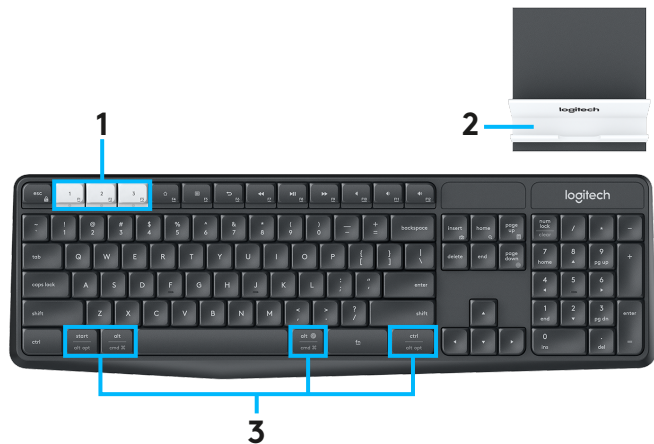

# 連線

K375s 多工鍵盤讓您可透過 *Bluetooth Smart* 或預先配對好的 Unifying USB 接收器，最多連線到三個裝置。

## 快速設定

請依照這些步驟輕鬆連線到您的電腦、筆記型電腦或平板電腦。  
關於如何透過 Unifying 或 *Bluetooth Smart* 連線的詳細資訊，請參閱下方章節。

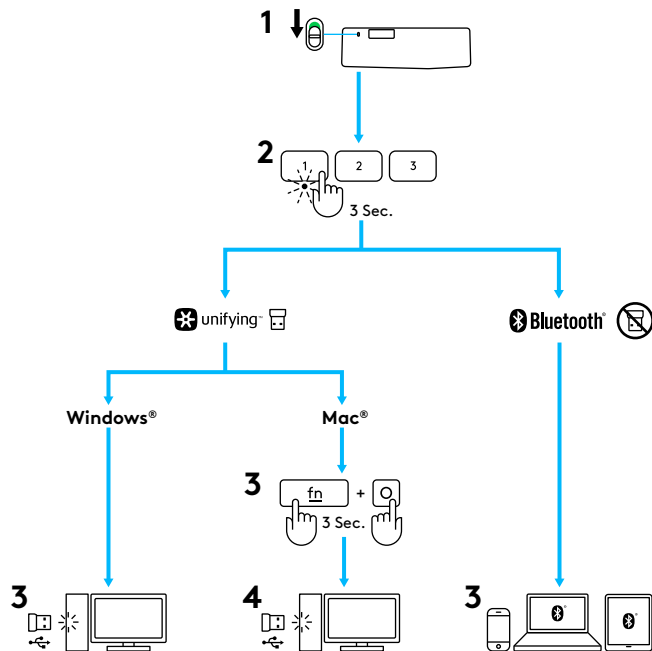

# 使用 UNIFYING 連線

K375s 多工鍵盤隨附有已預先配對的接收器，為您的電腦或筆記型電腦提供隨插即用的便利連線。如果您想要對包裝盒內的接收器進行第二次配對，或對現有的 Unifying 接收器進行配對，請遵循這些步驟。

## 需求條件

- USB 連接埠
- Unifying 軟體
- Windows® 10 或更新版本、Windows® 8、Windows® 7
- Mac OS X 10.10 或更新版本
- Chrome OS™

## 如何連線

- 1 下載 Unifying 軟體。您可以在 [www.logitech.com/unifying](http://www.logitech.com/unifying) 下載此軟體。
- 2 確認鍵盤電源已開啓。
- 3 按住白色 Easy-Switch 按鍵之一三秒鐘。(所選頻道上的 LED 指示燈會快速閃爍。)
- 4 依照您的作業系統設定鍵盤：
  - 對於 Mac OS /iOS：  
按住 **fn + o** 三秒鐘。  
(所選頻道上的 LED 指示燈會亮起。)
  - 對於 Windows、Chrome 或 Android：  
按住 **fn + p** 三秒鐘  
(所選頻道上的 LED 指示燈會亮起。)
- 5 插入 Unifying 接收器。
- 6 開啓 Unifying 軟體，然後遵循螢幕上的指示。

## 使用 *BLUETOOTH SMART* 連線

K375s 多工鍵盤讓您可透過 *Bluetooth Smart* 連線。請確認您的裝置可使用 *Bluetooth Smart*，並執行下列作業系統之一：

### 需求條件

- Windows® 10 或更新版本、Windows® 8
- Android™ 5.0 或更新版本
- Mac OS X 10.10 或更新版本
- iOS 5 或更新版本
- Chrome OS™

### 如何連線

- 1 確認 K375s 多工鍵盤已開啓電源，且您的電腦、平板電腦或手機上已開啓藍牙。
- 2 按住白色 Easy-Switch 按鍵之一三秒鐘。(所選頻道上的 LED 指示燈會快速閃爍。)
- 3 在您的裝置上開啓藍牙設定，然後與「鍵盤 K375s」配對。
- 4 在螢幕上鍵入密碼，然後按下 enter 或 return 鍵。

## 增強功能

K375s 多工鍵盤擁有多種增強功能，讓您可從您的新鍵盤獲得更多。可使用下列增強功能與快捷鍵。

### 熱鍵和媒體鍵







下表顯示 Windows®、Mac OS、Android™ 和 iOS 可用的熱鍵和媒體鍵。

									
Windows® 10	任務檢視	右鍵功能表	在瀏覽器中後退	上一曲目	播放/暫停	下一曲目	靜音	調低音量	調高音量
Windows® 8 Windows® 7	瀏覽器的首頁	右鍵功能表	在瀏覽器中後退	上一曲目	播放/暫停	下一曲目	靜音	調低音量	調高音量
Android™	首頁	功能表	後退	上一曲目	播放/暫停	下一曲目	靜音	調低音量	調高音量
iOS	首頁	顯示/隱藏 虛擬鍵盤	首頁	上一曲目	播放/暫停	下一曲目	靜音	調低音量	調高音量
Mac OS	任務控制	Dashboard/ launchpad*	在瀏覽器中 後退*	上一曲目	播放/暫停	下一曲目	靜音	調低音量	調高音量

\*需要安裝 Logitech Options 軟體

## Fn 快捷鍵

若要執行快捷鍵，請在按住 **fn** (功能) 鍵的同時按下與動作關聯的按鍵。下表顯示不同作業系統的功能鍵組合。

						
Windows® 10	鎖定 F 功能鍵	F 功能鍵	螢幕截圖	Cortana 搜尋	小算盤	切換語言
Windows® 8 Windows® 7	鎖定 F 功能鍵	F 功能鍵	螢幕截圖	搜尋	小算盤	切換語言
Android™	鎖定 F 功能鍵	—	螢幕截圖	搜尋	—	—
iOS	鎖定 F 功能鍵	—	螢幕截圖	搜尋	—	切換語言
Mac OS	鎖定 F 功能鍵	F 功能鍵	螢幕截圖	Finder 中聚焦	—	切換語言

## 兩種鍵盤配置

獨特的兩種標示按鍵讓 K375s 多工鍵盤與不同的作業系統 (例如 Mac OS、iOS、Windows、Chrome OS、Android) 相容。按鍵透過標籤顏色和分割線區分針對不同作業系統保留的功能或符號。

### 按鍵標籤顏色

灰色標籤指示的功能在執行 OSX 或 iOS 的 Apple 裝置上有效。



帶灰色圓圈和白色標籤的符號是保留供 Windows® 電腦上的 Alt GR 使用的符號。



### 分列按鍵

空白鍵任一側的輔助按鍵會顯示兩組標籤，由分割線隔開。分割線上方的標籤用以指明會傳送至 Windows 或 Android 裝置的輔助鍵符。

分割線下方的標籤用以指明會傳送至 Apple 電腦、iPhone 或 iPad 的輔助鍵符。鍵盤將自動使用與目前所選裝置相關的輔助鍵符。



### 如何設定您的鍵盤

若要根據您的作業系統設定配置，您必須按住下列快捷鍵之一 3 秒鐘。(在配置已設定後，所選頻道上的 LED 指示燈會亮起以表示確認。)

iOS: **fn + i**



Mac OS : **fn + o**



Windows: **fn + p**



如果使用 Bluetooth Smart 連線，則不需要此步驟，因為作業系統偵測會自動完成設定。



# K375S 멀티 디바이스 무선 키보드

- 1 3개 채널의 이지 스위치 키
- 2 스마트폰/태블릿 거치대
- 3 듀얼 프린트 레이아웃: Windows®/Android™ 및 Mac OS /iOS
- 4 높이 조절 받침대
- 5 배터리 도어
- 6 이중 연결: Unifying 수신기 및 Bluetooth® Smart

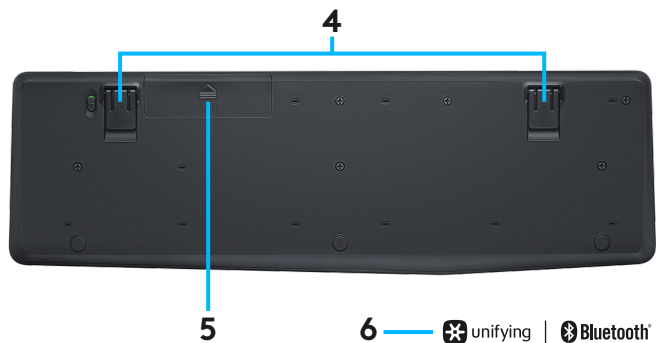
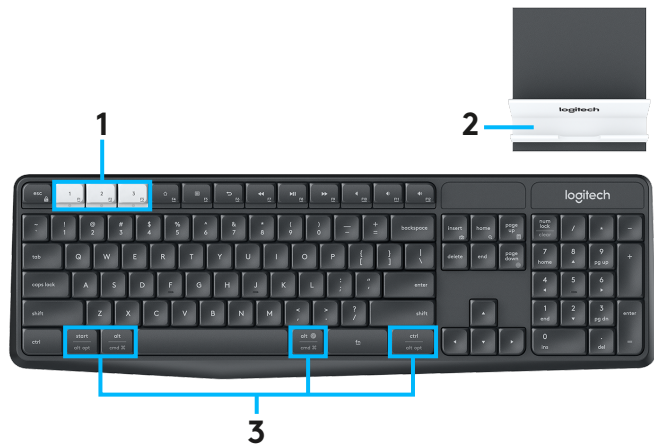

# 연결하기

K375s 멀티 디바이스 무선 키보드 및 스탠드를 이용하면 Bluetooth Smart 또는 사전 페어링되어 포함된 Unifying USB 수신기를 통해 최대 3대의 장치를 연결할 수 있습니다.

## 빠른 설치

컴퓨터, 노트북 또는 태블릿에 빠르게 연결하려면 다음의 단계를 따르십시오. Unifying 또는 Bluetooth Smart 연결 방법에 대한 자세한 내용은 다음 섹션으로 이동하십시오.

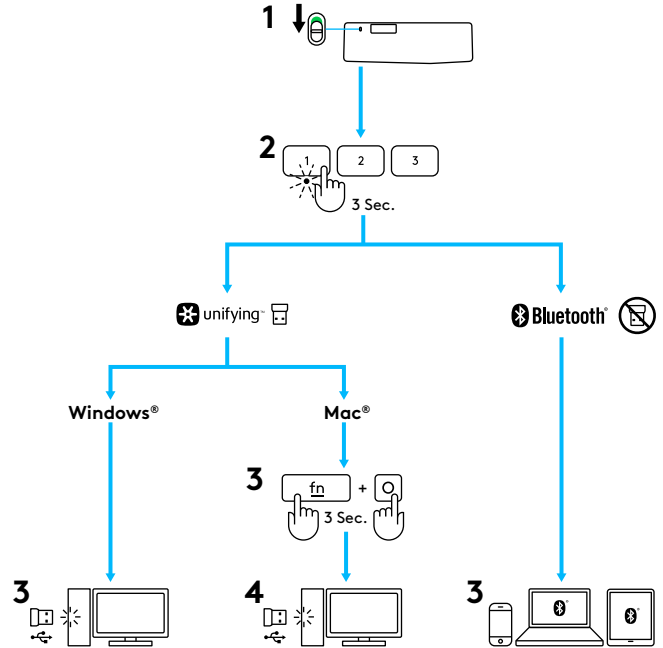

# UNIFYING을 사용한 연결

K375s 멀티 디바이스 무선 키보드는 컴퓨터 또는 노트북에 대해 플러그 앤 플레이 연결을 제공하는 사전 페어링된 수신기가 함께 제공됩니다. 기본 제공되는 수신기에 다시 페어링을 해야 하거나 기존에 보유하고 계신 다른 Unifying 수신기에 페어링할 경우, 다음의 단계를 따르십시오.

## 요구 사항

- USB 포트
- Unifying 소프트웨어
- Windows® 10 이상, Windows® 8, Windows® 7
- Mac OS X 10.10 이상
- Chrome OS™

## 연결 방법

- 1 Unifying 소프트웨어를 다운로드합니다. [www.logitech.com/unifying](http://www.logitech.com/unifying)에서 소프트웨어를 다운로드할 수 있습니다.
- 2 키보드가 켜져 있는지 확인합니다.
- 3 흰색 이지 스위치 키 중 하나를 3초 동안 누릅니다. (선택한 채널의 LED가 빠르게 깜박입니다.)
- 4 운영 체제에 따라 키보드를 구성합니다.
  - Mac OS /iOS:  
**fn + o**를 3초 동안 누릅니다.  
(선택한 채널의 LED에 불이 켜집니다.)
  - Windows, Chrome 또는 Android:  
**fn + p**를 3초 동안 누릅니다  
(선택한 채널의 LED가 점등됨).
- 5 Unifying 수신기에 연결합니다.
- 6 Unifying 소프트웨어를 열고 화면에 나타나는 지침을 따릅니다.

## BLUETOOTH SMART를 사용한 연결

K375s 멀티 디바이스 무선 키보드는 Bluetooth Smart를 통해 연결할 수 있습니다. 사용 중인 장치가 Bluetooth Smart를 지원하는지, 다음 운영 체제 중 하나를 실행 중인지 확인하십시오.

### 요구 사항

- Windows® 10 이상, Windows® 8
- Android™ 5.0 이상
- Mac OS X 10.10 이상
- iOS 5 이상
- Chrome OS™

### 연결 방법

- 1 K375s 멀티 디바이스 무선 키보드가 켜져 있는지, 컴퓨터, 태블릿 또는 전화기에서 Bluetooth가 활성화되었는지 확인합니다.
- 2 흰색 이지 스위치 키 중 하나를 3초 동안 누릅니다. (선택한 채널의 LED가 빠르게 깜박입니다.)
- 3 장치에서 Bluetooth 설정을 열고 "키보드 K375s"와 페어링합니다.
- 4 화면상 비밀번호를 입력하고 Enter 또는 Return 키를 누릅니다.

# 향상된 기능

K375s 멀티 디바이스 무선 키보드는 다양한 기능을 제공합니다. 아래 내용을 참조하시면 좀 더 효과적으로 활용하실 수 있습니다.

## 단축키 및 미디어 키













아래 표는 Windows®, Mac OS, Android™ 및 iOS에서 사용 가능한 단축키와 미디어 키를 보여줍니다.

									
Windows® 10	작업 보기	상황별 메뉴	브라우저 뒤로 가기	이전 트랙	재생/일시 정지	다음 트랙	음소거	볼륨 줄이기	볼륨 높이기
Windows® 8 Windows® 7	브라우저 홈 페이지	상황별 메뉴	브라우저 뒤로 가기	이전 트랙	재생/일시 정지	다음 트랙	음소거	볼륨 줄이기	볼륨 높이기
Android™	Home	메뉴	뒤로 가기	이전 트랙	재생/일시 정지	다음 트랙	음소거	볼륨 줄이기	볼륨 높이기
iOS	Home	가상 키보드 표시/숨기기	홈	이전 트랙	재생/일시 정지	다음 트랙	음소거	볼륨 줄이기	볼륨 높이기
Mac OS	미션 컨트롤	대시보드/ 런치패드*	브라우저 뒤로 가기*	이전 트랙	재생/일시 정지	다음 트랙	음소거	볼륨 줄이기	볼륨 높이기

\*Logitech Options 소프트웨어 설치 필요

## Fn 바로가기

바로가기를 수행하려면 동작과 연결된 키를 누른 상태로 **fn** (기능) 키를 누릅니다. 아래 표는 운영 체제별 특수 키 조합을 보여줍니다.

	 + 	 + 	 + 	 + 	 + 	 + 
Windows® 10	F-기능 잠금	F-기능	Print Screen	Cortana 검색	계산기	언어 전환
Windows® 8 Windows® 7	F-기능 잠금	F-기능	Print Screen	검색	계산기	언어 전환
Android™	F-기능 잠금	—	화면 인쇄	검색	—	—
iOS	F-기능 잠금	—	스크린샷	검색	—	언어 전환
Mac OS	F-기능 잠금	F-기능	화면 인쇄	파인더의 소프트라이트	—	언어 전환

# 듀얼 레이아웃

독특한 듀얼 프린트 키 덕분에 여러 운영 체제(예: Mac OS, iOS, Windows, Chrome OS, Android)에서 K375s 멀티-디바이스가 원활히 호환됩니다. 키 라벨 색상과 구분 선이 각 운영 체제의 기능이나 기호를 표시합니다.

## 키 라벨 색상

회색 라벨은 Mac OS 또는 iOS 방식의 Apple 장치에서 이용 가능한 기능을 나타냅니다.



회색 바탕의 흰색 라벨은 Windows 컴퓨터에서 Alt GR과의 조합으로 입력되는 기호를 나타냅니다.



## 구분된 키

스페이스바 양쪽에 위치한 기능키에는 구분선으로 나뉜 두 라벨이 표기되어 있습니다.

구분선 위의 라벨은 Windows 또는 Android 장치에 할당된 기능을 나타냅니다.

구분선 아래의 라벨은 Apple 컴퓨터, iPhone 또는 iPad에 할당된 기능을 나타냅니다. 키보드는 현재 페어링된 장치에 할당된 기능을 자동으로 선택합니다.



## 키보드 구성 방법

운영 체제에 따라 레이아웃을 구성하려면 다음의 바로가기 중 하나를 3초 동안 눌러야 합니다. (레이아웃이 구성되었을 때를 확인하기 위해 선택한 채널의 LED가 점등됩니다.)

iOS: **fn + i**



Mac OS : **fn + o**



Windows: **fn + p**



Bluetooth Smart에 연결한 경우 OS 검색이 자동으로 구성되므로 이 단계가 필요하지 않습니다.

© 2016 Logitech. Logitech, Logi, and other Logitech marks are owned by Logitech and may be registered. The *Bluetooth*® word mark and logos are registered trademarks owned by Bluetooth SIG, Inc. and any use of such marks by Logitech is under license. All other trademarks are the property of their respective owners.

版權所有 © 2016 年羅技。羅技、Logi 和其他羅技商標均歸羅技所有，並或已註冊。藍牙™ 文字商標和標志為 Bluetooth SIG, Inc. 所有的註冊商標。所有其它商標均是其各自所有者的財產。

版權所有 © 2016 年羅技。羅技、Logi 和其他羅技商標均歸羅技所有，並或已註冊。藍牙文字商標和標誌是 Bluetooth SIG, Inc. 的註冊商標。所有其他商標均是其各自所有人的財產。

© 2016 Logitech. All rights reserved. Logitech, Logi 및 기타 Logitech 상표는 Logitech의 소유이며 등록 상표일 수 있습니다. *Bluetooth*® 마크와 로고는 Bluetooth SIG, Inc.가 소유한 등록 상표입니다. 그 밖의 모든 상표는 해당 소유자의 자산입니다.