



- RE418 -

Logistics Thermal Label Printer

User Guide





Wram Tips

Our new item RE418 with retro style and good quality, can works with any thermal direct label including express waybill, logistics labels, commodity price tags, barcode and so on. Help save time and money on label cost. For the convenience of using the printer, please read the following user guide carefully. Operate with a incorrect way may damage to the printer.

There are video guide and drivers in the attached USB flash drive. Please view the files in the u-disk to download the driver, or download the latest driver in our website: <https://www.kcomer.com/>. If you have any questions or technical failures during the installation, please contact our technician at any time:

Email: service1@kcomer.com

Skype: [service1@kcomer.com](https://www.kcomer.com/)

Package contents



1 Standard Accessories:

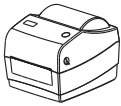

Printer

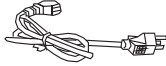

Power Cable

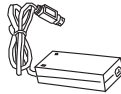

Adapter



USB Line



Quick Installation Guide

☺ The pictures are for reference only, please subject to practicality

2 Appearance and Components

■ Front View

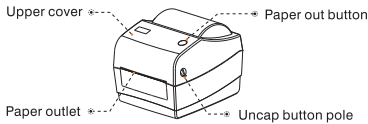

■ Rear View

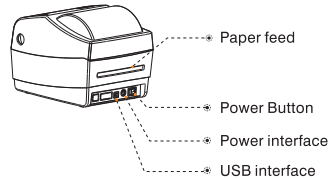

■ Inner View



Quick Printer Installation

 COMER / RE418

1

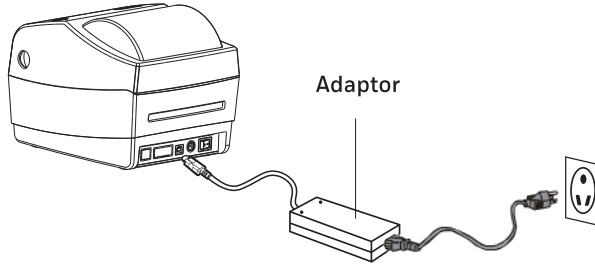

Power Connection

1. Confirm the printer is Power-off (0);
2. Connect the adapter to the printer;
3. Connect the adapter to one end of the power line;
4. Connect the other end of Power line to the socket.

2

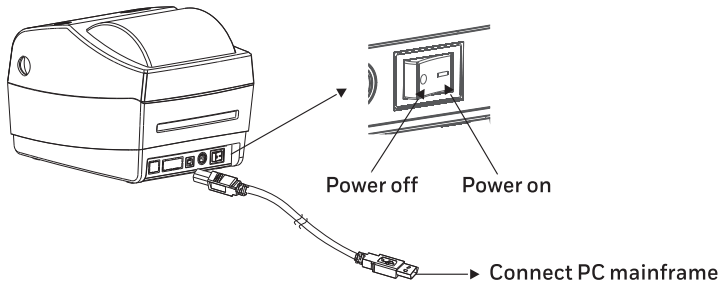

USB Connection

1. Connect USB to the printer;
2. Connect USB to the PC mainframe;
3. Turn on the printer power to be Power- on (I).

Consumables Installation

 COMER / RE418

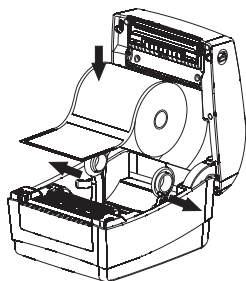

1. Open fixing seat, put in paper roll with printed face above.

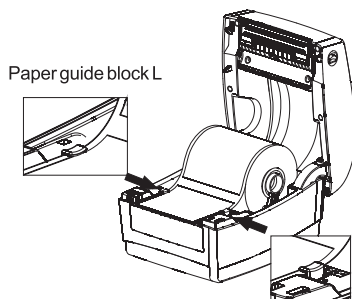

Paper guide block L

Paper guide block R

2. Make paper front through paper guide, pull paper exceed rubber roller, adjust paper guide to fix the paper according to the paper width.

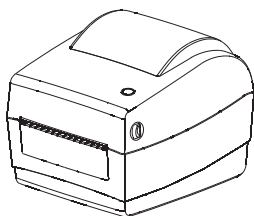

3. Close printer cover, press down to hear “ka” to lock

Outside-scroll Installation

 COMER / RE418

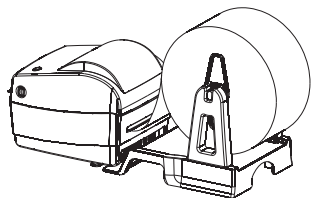

1. Make paper front through paper-feeding slot on the back of printer, confirm the printed face on above.

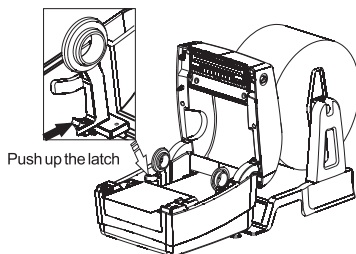

2. Open fixing seat, push up the L seat to lock.

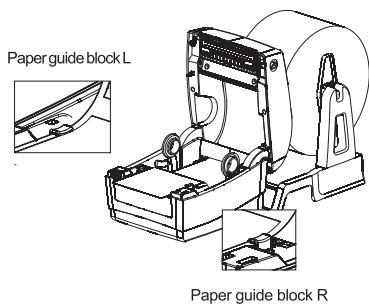

3. Make paper front through paper guide, pull paper exceed rubber roller, adjust paper guide to fix the paper according to the paper width.

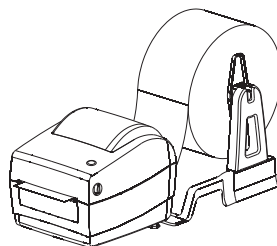

4. Close printer cover, press down to hear "ka" to lock.

Driver Installation&Print Test



Note:

1. Please download the driver from website(<https://kcomer.com>) or u-disk.
2. The driver file is safe, please rest assured to install.
3. There are detailed guide and video for your reference, if you still have problems or questions, please contact us for help, Email:service1@kcomer.com



1. Please contact the printer to computer and ensure the printer is on, download the windows driver and run it.
For safety and file size considerations, the driver file is placed within zip file in website. Please use unzip tool to unzip the driver (As the pic shows)

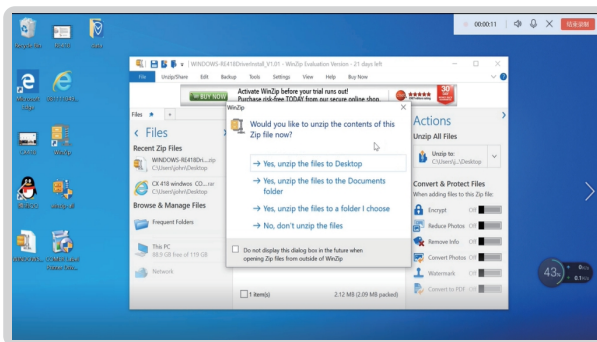

2. Find the driver and prompt to install.

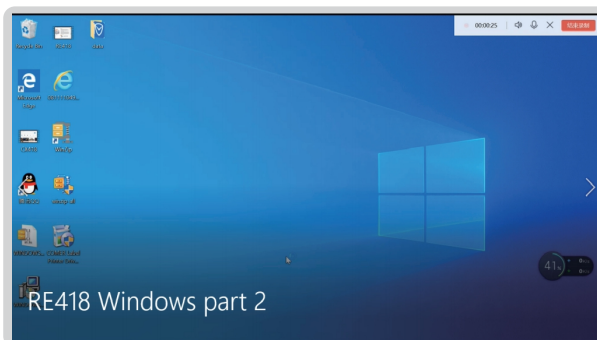

3. Installed successfully.

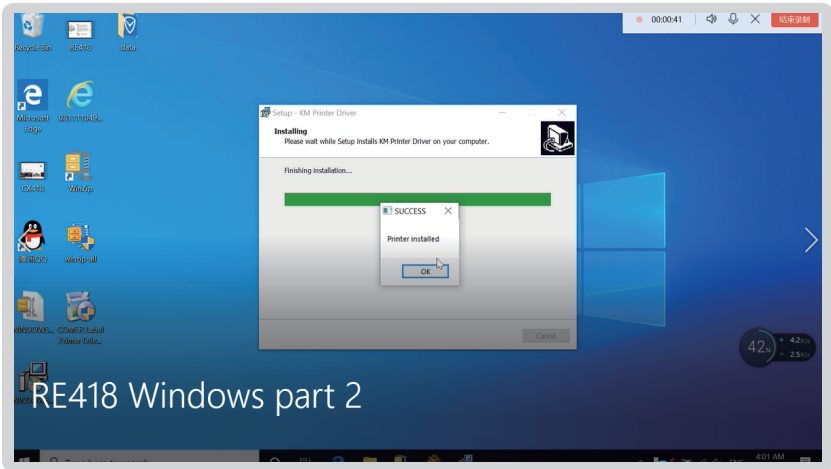

4. After installation, place direct thermal label, then start to print a test page and set print parameter.

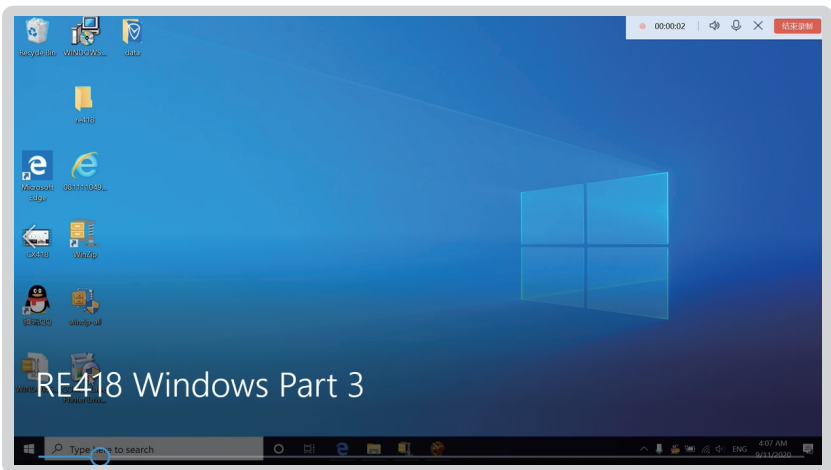

- Find the installed printer(RE418). Click **Setting** - **Devices** - **Printer and Scanners** for windows 10 (as the pic shows), or click **Control Panel** - **Devices and Printers** for windows 7.

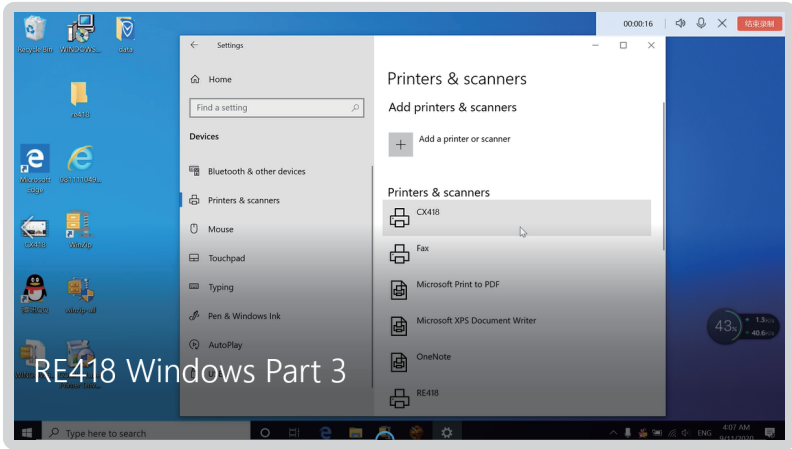

- Click "print a test page" and the test page will show the detailed information of the printer. Click "Printer Properties" to set print density, print speed and so on.

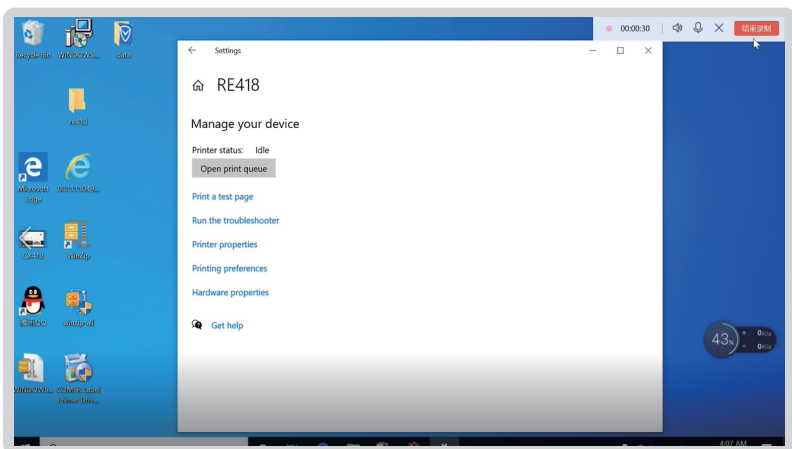

1. Please contact the printer to computer and ensure the printer on, download the windows driver from website or u-disk.

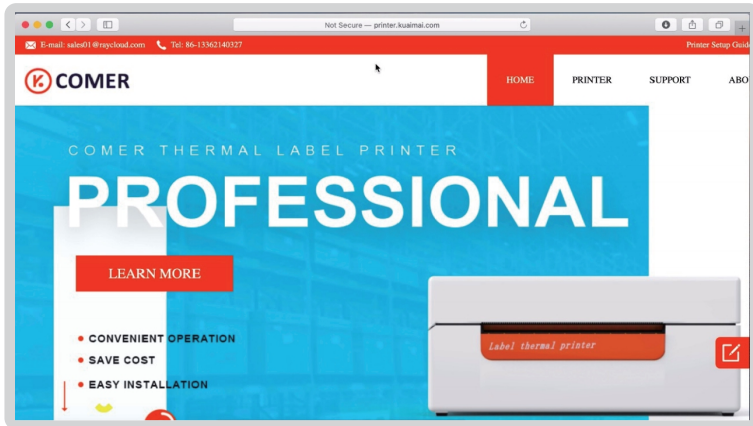

2. Note: If there is a error “the pkg file can’t be opened because it is from unidentified developer” when installing the MAC driver, please allow the macOS to finish the installation :

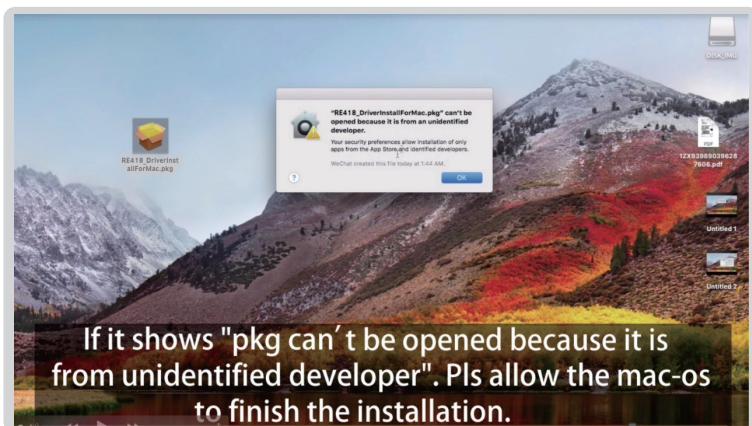

3. Go to the "Security & Privacy", to allow the driver open (As the picture shows)

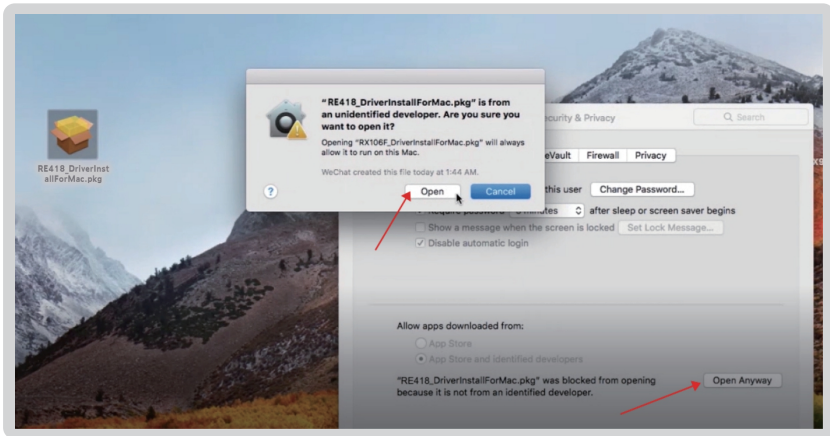

4. Continue to install the driver.

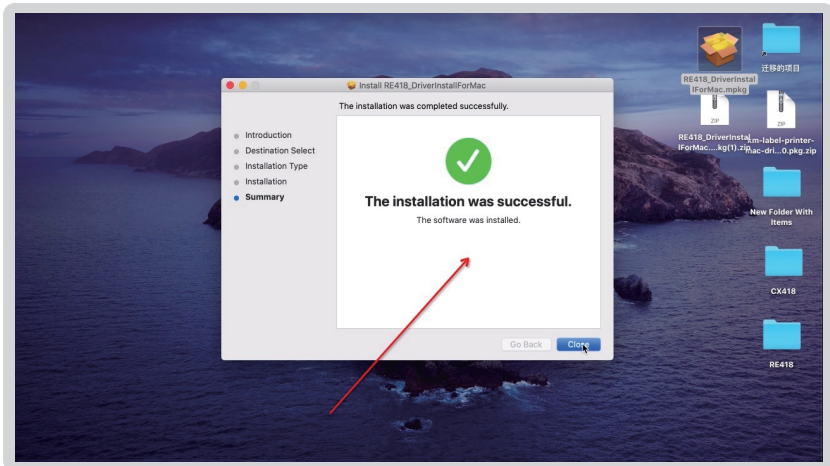

Next how to find the RE418 printer in your Mac?

1. Pls find the installed printer driver in the launchpad of your Mac.

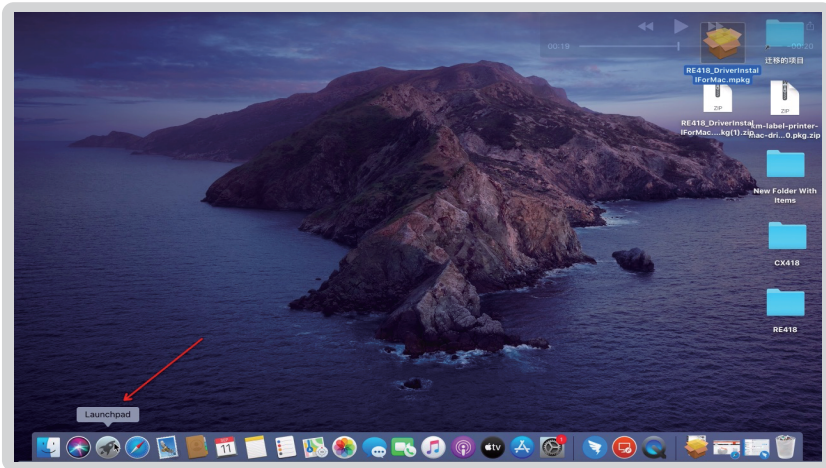

2. Pls click the system preference.



3. Select **【Setting&Scanners】**

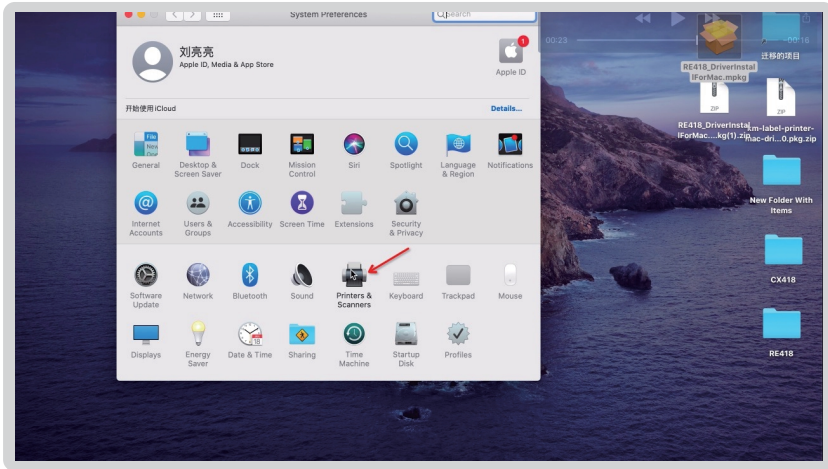

4. Add the RE 418 printer.

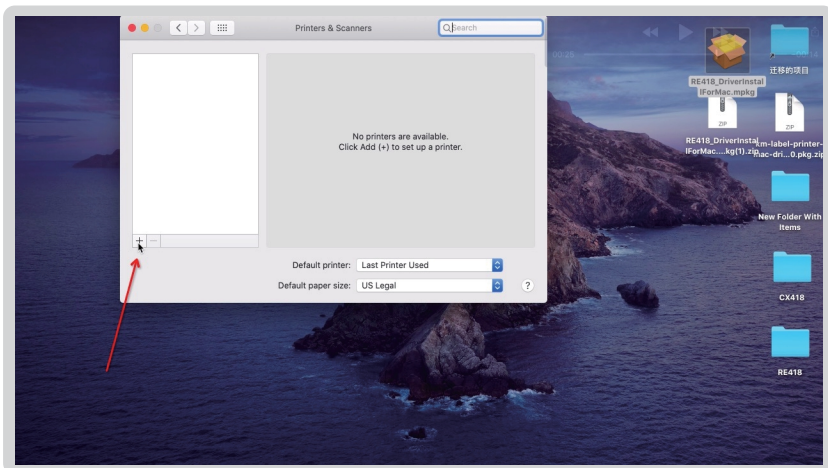

3. If the pages display your printer information, the installation succeeds.

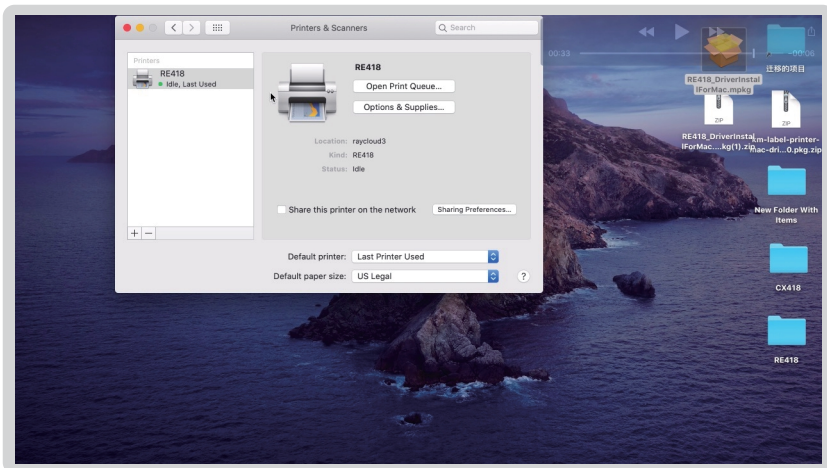
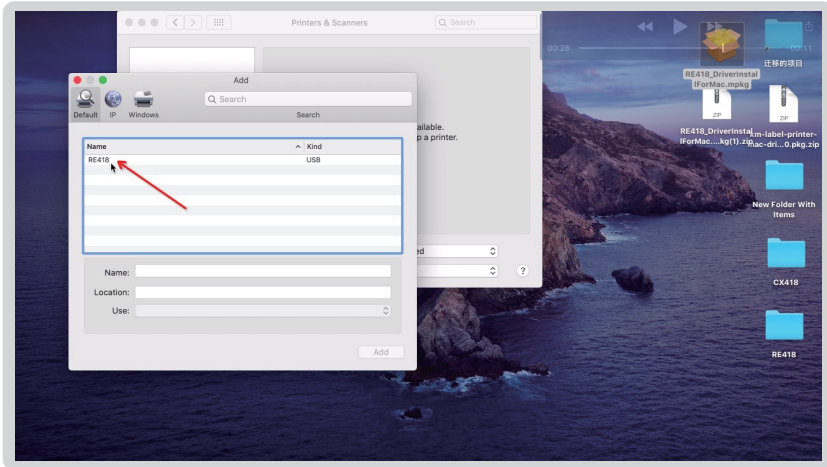

5. Set the print size according to your needs.

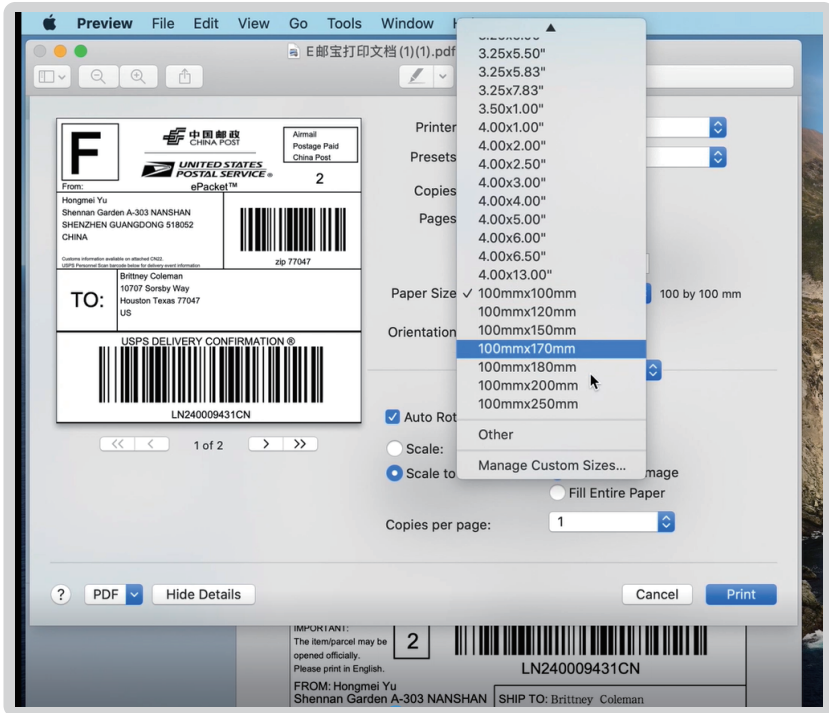

Button "FEED" Instruction

Printer Status	Operation of FEED	Function
Standby	Press	Feed in a blank paper automatically
Standby	Press(3 seconds)	Enter into the learn mode of cover sheet
Power off	Hold(release after power on)	Print out self test page
Open the cover	Press 10 seconds	Factory Reset
Continuous printingPrint	Press	Print pause
Print pause	Press	Resume Printing

Indicator Light Instruction

Indicator Light Status	Printer Status	
Indicator Light ON	Standby	
Indicator Light Flashing	Buzzer Warning	
Buzzer Warning	Twice	Movement error
	Three times	Lack paper error
	Five times	Overheating
	Six times	Uncover error
	Seven times	Seam standard error



The printer uses Tips:

Note:

1. To ensure the optimal print quality, please use the original factory power adapter.
2. Please avoid to use the poor quality label which wear the printer and cause damage to the printer.
3. Please clean the print head regularly to ensure the high-quality print effect.
4. When replacing the label specification (including the label thickness, size and quality) , please do “Automatic label identification”.
5. If the label quality is good and printer head has been cleaned, print effect still can't meet the requirement, please adjust the print density, the range from 0 to 15 levels.
6. The printer has paper absorption function, please load label directly from the paper inlet. If open the cover to place the label, the label should be over the paper outlet a little (length less than one label) to avoid waste.



Printer Data Sheet

 **COMER / RE418**

Brand	Comer
Method	Direct Thermal
Resolution	203 dpi
Max Printing Speed	150 mm/s
Interface	USB
Printing Width	104mm
Paper Width	48-108 mm
Power Adapter	24 V / 2A

The Comer thermal printer is covered by one-year warranty.

For any questions or suggestions,
please email to service1@kcomer.com

For any further information,
please visit our website:

<https://kcomer.com>

