

# FDFAAP INSTALLATION INSTRUCTIONS

DOUBLE FOLDAWAY UNIVERSAL PLATE MOUNT INSATLLATION

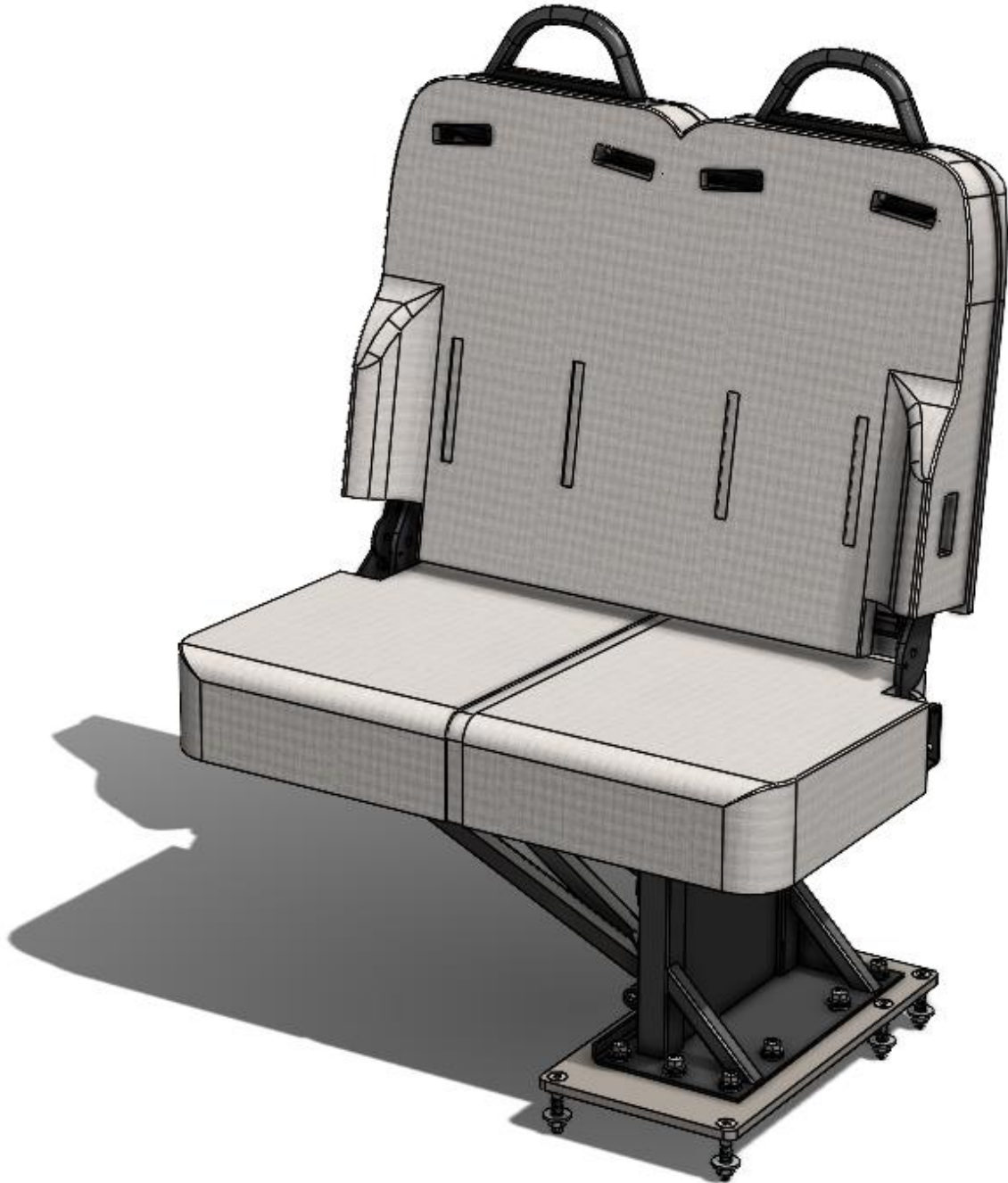



# FDFAAP INSTALLATION INSTRUCTIONS





DOUBLE FOLDAWAY UNIVERSAL PLATE MOUNT INSATLLATION

## READ BEFORE INSTALLATION

- Professional Installation with proper training is recommended. It is up to the installer to check for under floor obstructions (i.e., fuel tanks, fuel lines, brake lines, modules, wiring and etc.) or any other item that can be damaged by the installation of the flooring system. Clearances are the responsibility of the installer.
- Use of a stop collar on drill bits is strongly recommended.
- Lower or remove the fuel tank before beginning installation if the pod is to be installed anywhere in the vicinity of the tank. **DANGER** – NO UNPROTECTED BOLTS SHOULD POINT IN THE DIRECTION OF ANY PART OF THE FUEL SYSTEM. THE ENDS OF THESE BOLTS MUST BE PERMANENTLY CAPPED OR SHIELDED IN SOME MANNER TO AVOID PUNCTURING THE FUEL SYSTEM IN THE EVENT OF AN ACCIDENT
- If necessary, lower or remove the spare tire before beginning installation.
- Use only hardware supplied with kit (If a longer bolt is needed see the table for equivalent hardware and specifications.)
- Do not over tighten hardware (maximum 30 ft-lb).
- Do not under tighten hardware.
- Use rust inhibiting treatments on all raw edges.
- Thoroughly seal all holes to prevent moisture, dust and fume infiltration.
- OEM or custom floor should be cut to fit around the pod. The seat pod must *NOT* be installed over carpet, padding, or any other flexible flooring material. It must be placed flat against solid, structural flooring surface. This seat pod is designed to be bolted in only and *NOT* to be welded or fastened in any other manner.

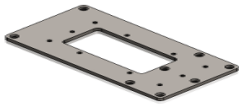
## Bill Of Materials

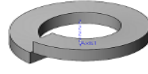
(Your kit should include the following components)

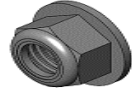
DOCUMENT PREVIEW	PART NUMBER	DESCRIPTION	QTY.
	FDFAAP	DOUBLE FOLDAWAY ADAPTOR PLATE	1
	90409A160	HSS 1/2-20 X 1" GRD. 8	10
	90850A300	1/2" GRD. 9 FLAT WASHER (ZINC PLATED)	10
	91104A033	1/2" SPLIT LOCK WAHER (ZINC PLATED)	10
	91253A724	FHS 1/2"-13 X 3"	7
	98026A033	1.375 O.D FLAT WASHER GRD 8	7
	92018A540	HSS FLANGE LOCKNUT 1/2-13	7



# FDFAAP INSTALLATION INSTRUCTIONS

DOUBLE FOLDAWAY UNIVERSAL PLATE MOUNT INSATLLATION

## Specifications for longer hardware

The following are the specifications of the hardware used during testing only use hardware the meets or exceeds these specifications.

<b>Thread Size</b>	1/2"-13
<b>Length</b>	3"
<b>Threading</b>	Partially Threaded
<b>Countersink Angle</b>	82°
<b>Material</b>	Black-Oxide Alloy Steel
<b>Hardness</b>	Rockwell C32
<b>Tensile Strength</b>	130,000 psi
<b>Thread Type</b>	UNC
<b>Thread Spacing</b>	Coarse
<b>Thread Fit</b>	Class 3A
<b>Thread Direction</b>	Right Hand
<b>Specifications Met</b>	ASME B18.3;ASTM F835
<b>RoHS</b>	RoHS 3 (2015/863/EU) Compliant
<b>REACH</b>	(EC 1907/2006) (01/16/2020, 205 SVHC) Compliant
<b>DFARS</b>	Specialty Metals Compliant (252.225-7009)
<b>USMCA Qualifying</b>	No
<b>Schedule B</b>	731815.9000
<b>ECCN</b>	EAR99

## Recommended McMaster Carr Hardware



**91253A726** - Black-Oxide Alloy Steel Hex Drive Flat Head Screw 1/2"-13 Thread Size, 3-1/2" Long



**91253A728** - Black-Oxide Alloy Steel Hex Drive Flat Head Screw 1/2"-13 Thread Size, 4" Long



**91253A730** - Black-Oxide Alloy Steel Hex Drive Flat Head Screw 1/2"-13 Thread Size, 4-1/2" Long



**91253A732** - Black-Oxide Alloy Steel Hex Drive Flat Head Screw 1/2"-13 Thread Size, 5" Long



**91253A734** - Black-Oxide Alloy Steel Hex Drive Flat Head Screw 1/2"-13 Thread Size, 5-1/2" Long



**91253A740** - Black-Oxide Alloy Steel Hex Drive Flat Head Screw 1/2"-13 Thread Size, 6" Long



**91253A746** - Black-Oxide Alloy Steel Hex Drive Flat Head Screw 1/2"-13 Thread Size, 6-1/2" Long



**91253A750** - Black-Oxide Alloy Steel Hex Drive Flat Head Screw 1/2"-13 Thread Size, 7" Long



# FDFAAP INSTALLATION INSTRUCTIONS

DOUBLE FOLDAWAY UNIVERSAL PLATE MOUNT INSATLLATION

## Recommended Installation Tools

- Drill
- Stop Collar
- 9/16 x 12 long Drill Bit
- Small-diameter Drill bit (for pilot hole)
- Ratchet
- 5/16" hex driver or Allen key
- 3/4" Socket
- 3/4" Open end wrench
- 3/8" Impact

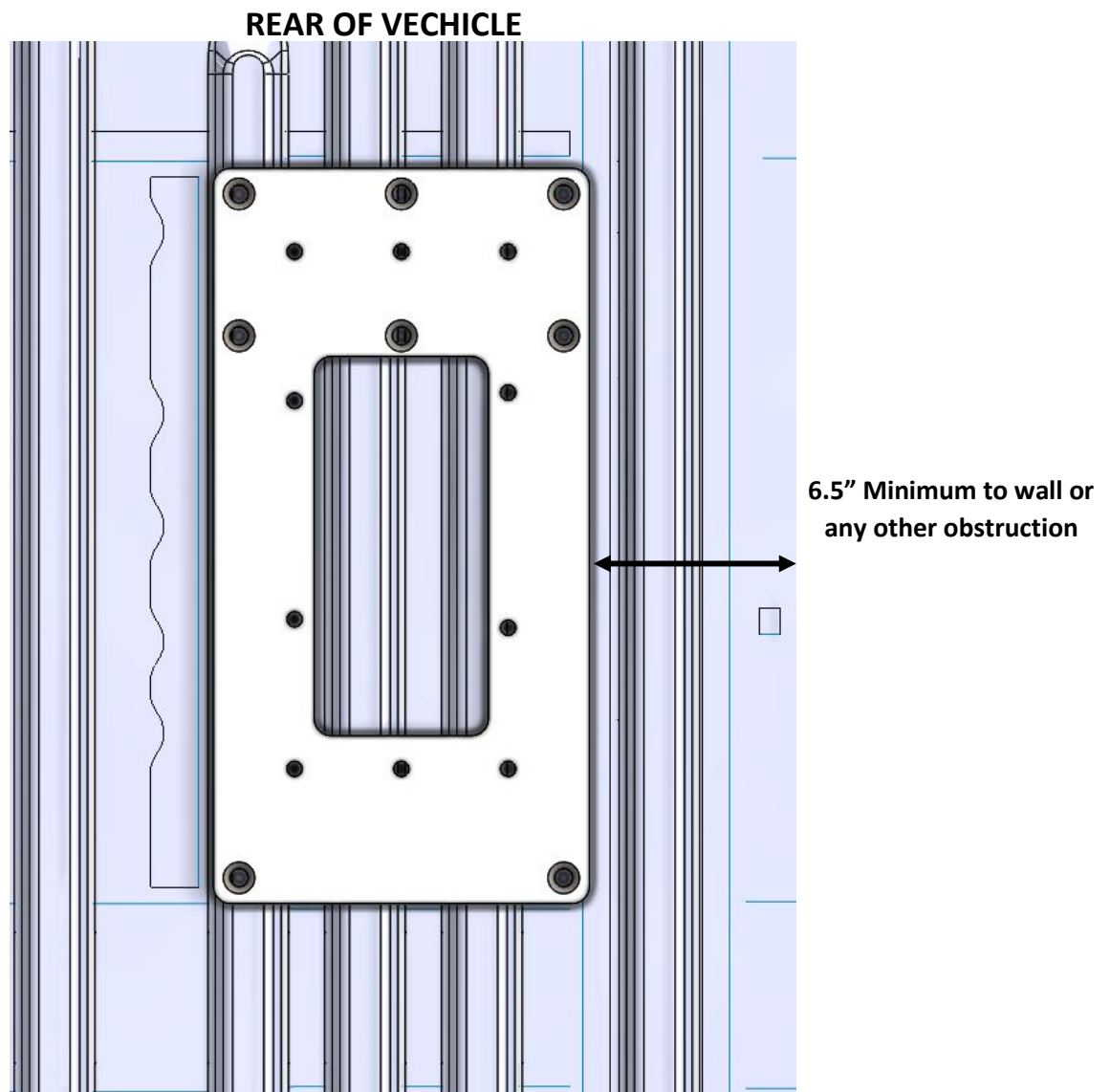

## Installation Instructions

- Begin by placing the Pod on the vehicle floor in the desired location making sure the pod is at minimum six and a half inches from the side wall panels as this will cause inference with opening the double foldaway seat if closer. Note the six countersunk holes must be towards the rear of the vehicle see below for reference.



## FDFAAP INSTALLATION INSTRUCTIONS

DOUBLE FOLDAWAY UNIVERSAL PLATE MOUNT INSATLLATION

- Now Carefully measure to determine if there are any hazards or obstructions under the floor that must be avoided or temporarily moved.
- Next mark the centers of the seven holes that are to be used. The six holes indicated with red rings  The area indicated with yellow rings  at least one of three holes must be used. Once the holes to be used have been determined and marked move the Pod and drill the seven holes.

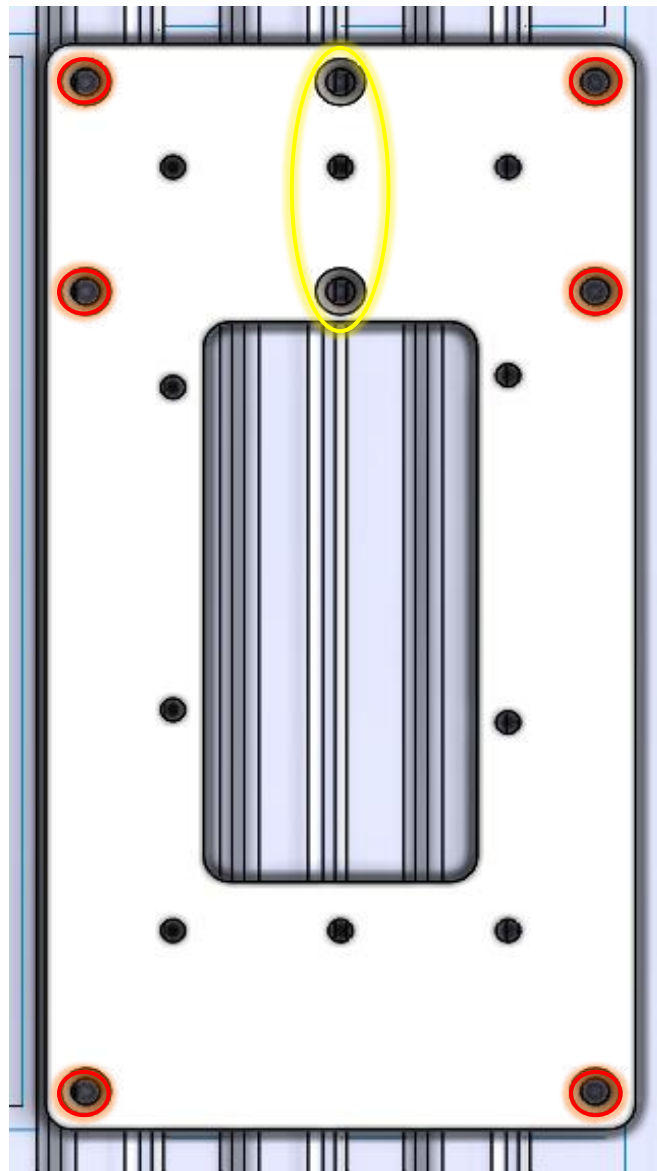



## FDFAAP INSTALLATION INSTRUCTIONS

DOUBLE FOLDAWAY UNIVERSAL PLATE MOUNT INSATLLATION

- Next deburr the edges of the holes drilled and apply some sort of rust inhibiting treatment to prevent corrosion of the exposed metal.
- Now place the Pod back in the location and place seven 91253A724 (FHS 1/2"-13 X 3" ) through the pod and the holes previously drilled as shown below.

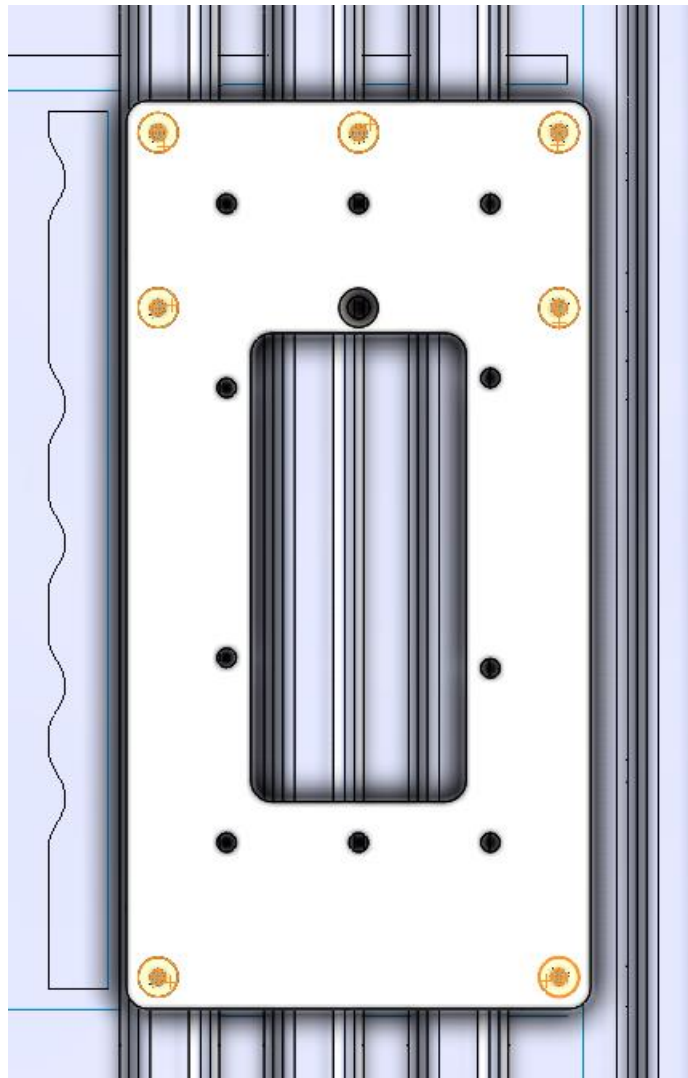

## FDFAAP INSTALLATION INSTRUCTIONS

DOUBLE FOLDAWAY UNIVERSAL PLATE MOUNT INSATLLATION

- Next from the underside of the vehicle seal around all seven bolts with something to prevents moisture and or debris from entering the vehicle. Then install seven 98026A033 ( 1.375 O.D FLAT WASHER GRD 8) and 92018A540 (HSS FLANGE LOCKNUT 1/2-13) and tighten to a maximum of 30-foot pounds and must have full flange nut engagement. Do not exceed 1/8" of sheet metal deformation. (NOTE: washers may clipped or ground to achieve clearance if necessary). See below for reference.

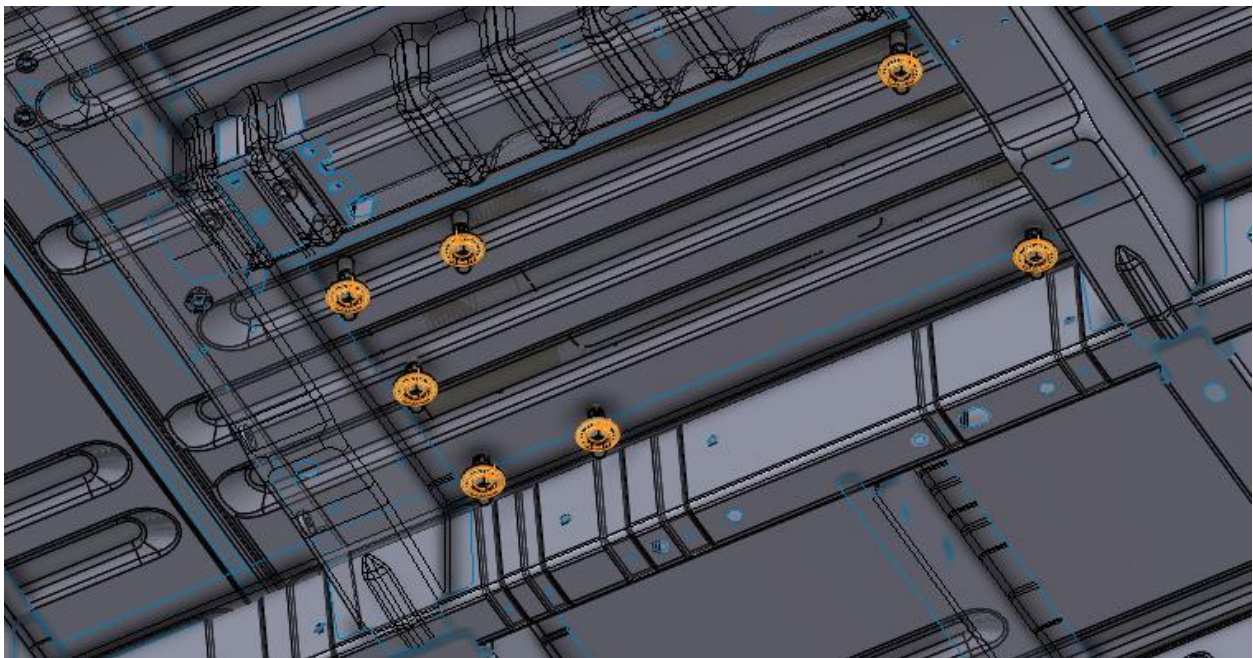

## FDFAAP INSTALLATION INSTRUCTIONS

DOUBLE FOLDAWAY UNIVERSAL PLATE MOUNT INSATLLATION

- Now set the double foldaway seat onto the plate and install ten 90409A160 (HHS 1/2-20 X 1" GRD. 8), ten 91104A033 (1/2" SPLIT LOCK WAHER (ZINC PLATED), and ten 90850A300 (1/2" GRD. 9 FLAT WASHER (ZINC PLATED)). Then tighten all until the lock washers is fully compressed. See below for reference.

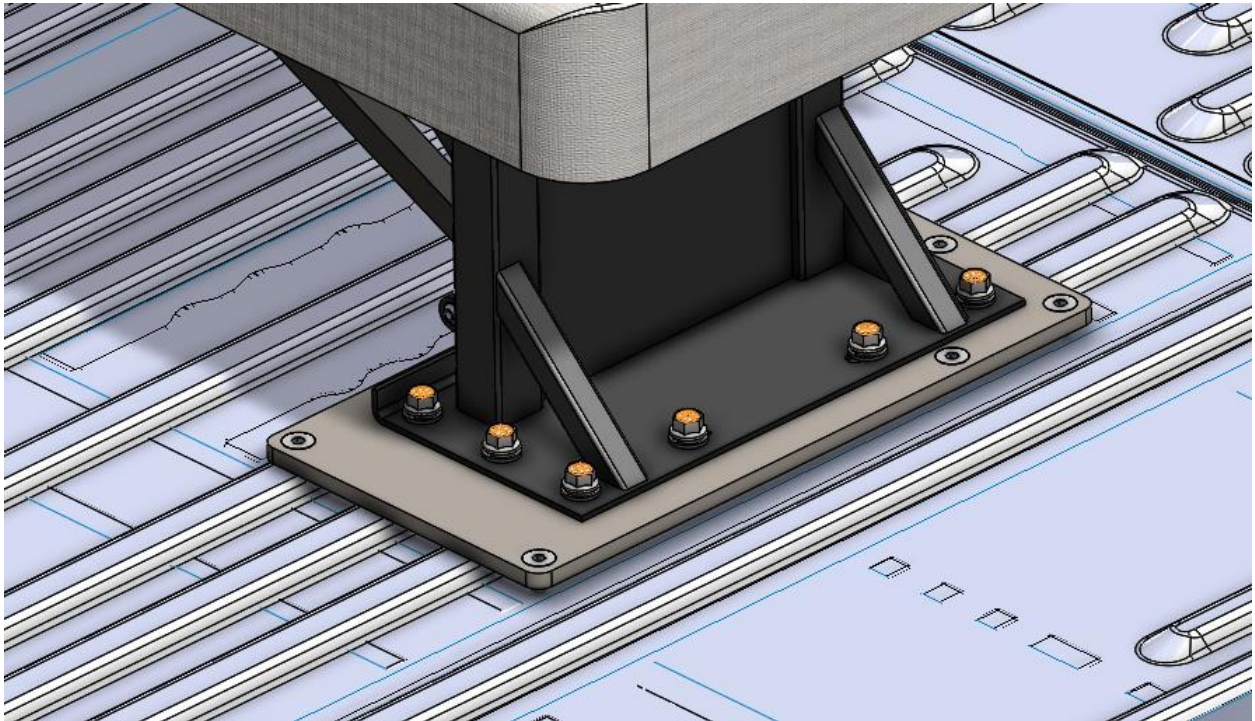

**FENTON**

**Always know,  
we are here to  
help**

Feel free to reach out  
with any questions or further  
assistance you may need

**Contact: [info@fentonmobility.com](mailto:info@fentonmobility.com) / (800) 500-6181 ext. 901**

 [fentonmobility.com](http://fentonmobility.com)