

ASSEMBLY INSTRUCTION
MONTERINGSANVISNING
MONTAGEANLEITUNG

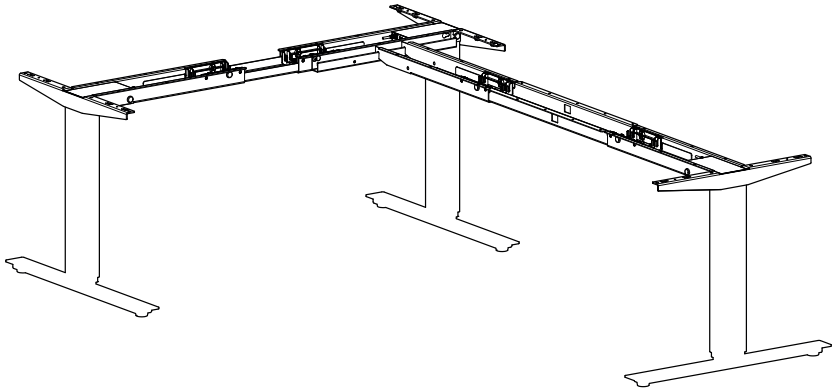

M132-141

V-02

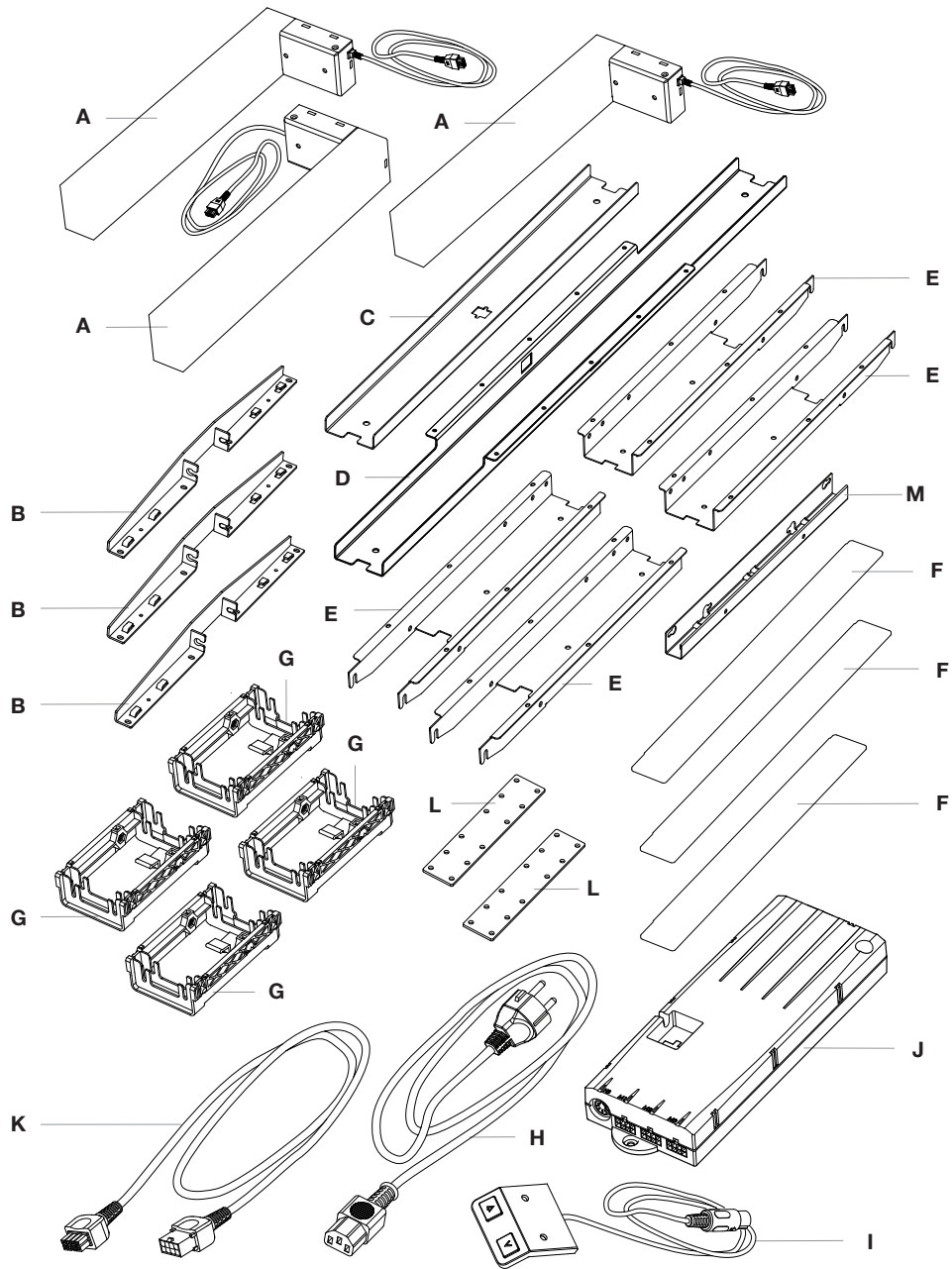

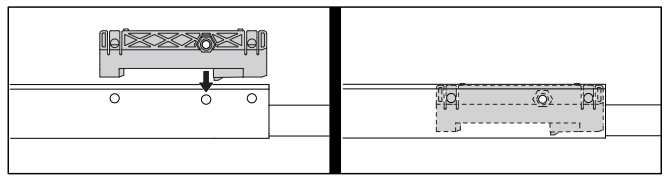
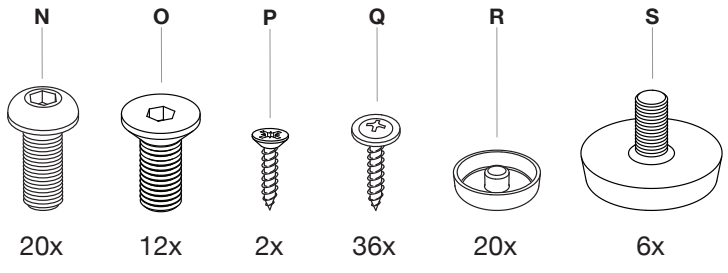

1:

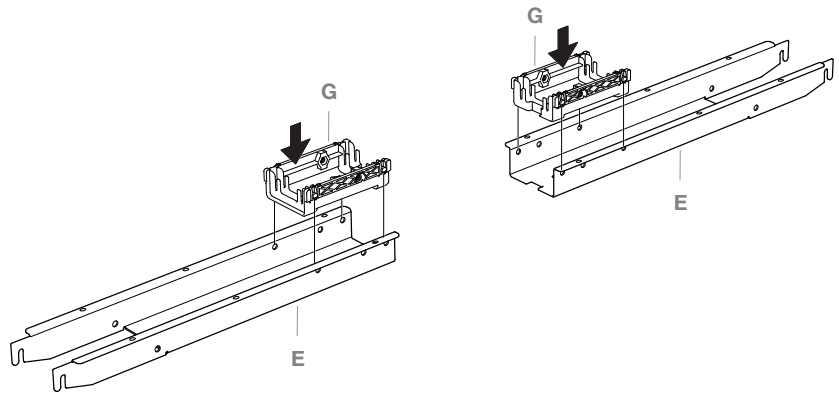

4:

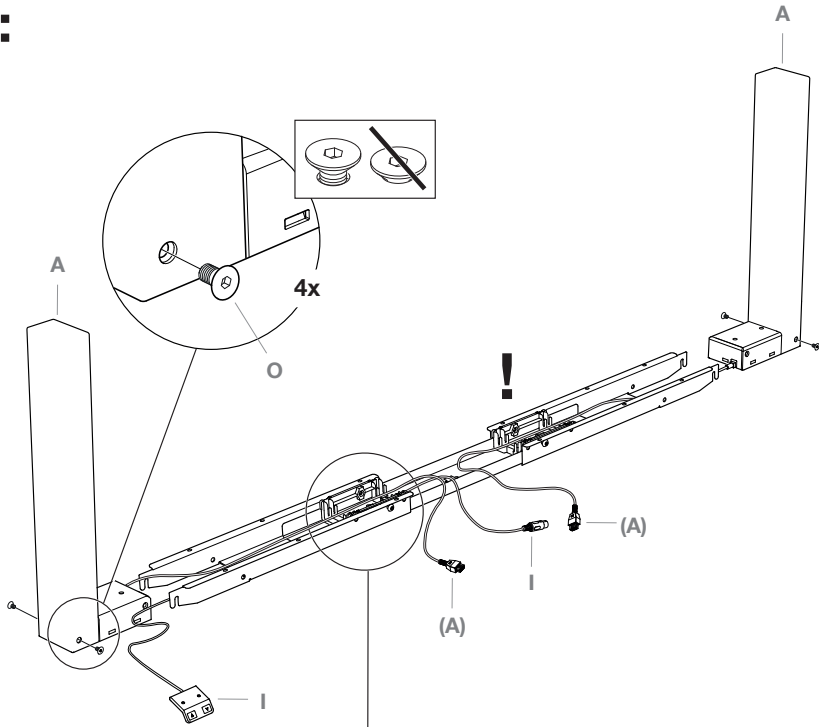

5:

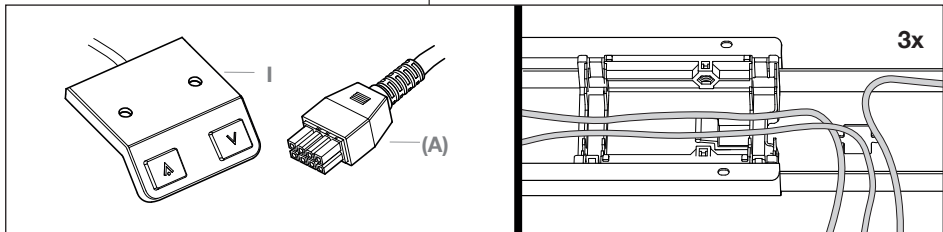

6:

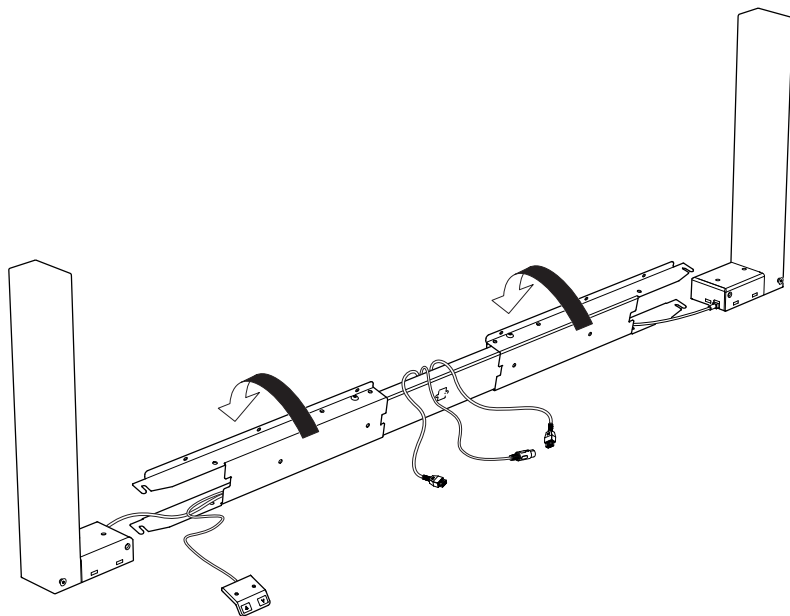

7:

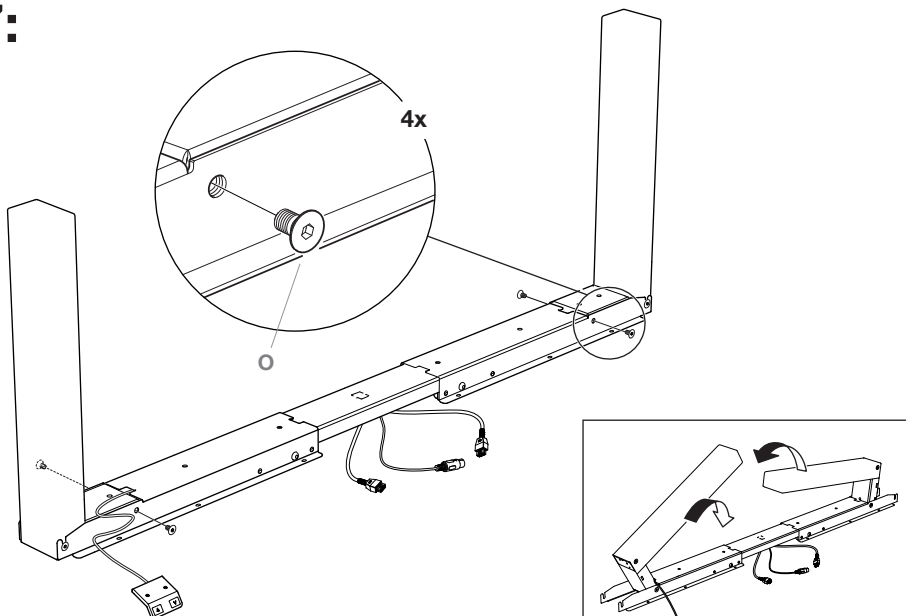

8:

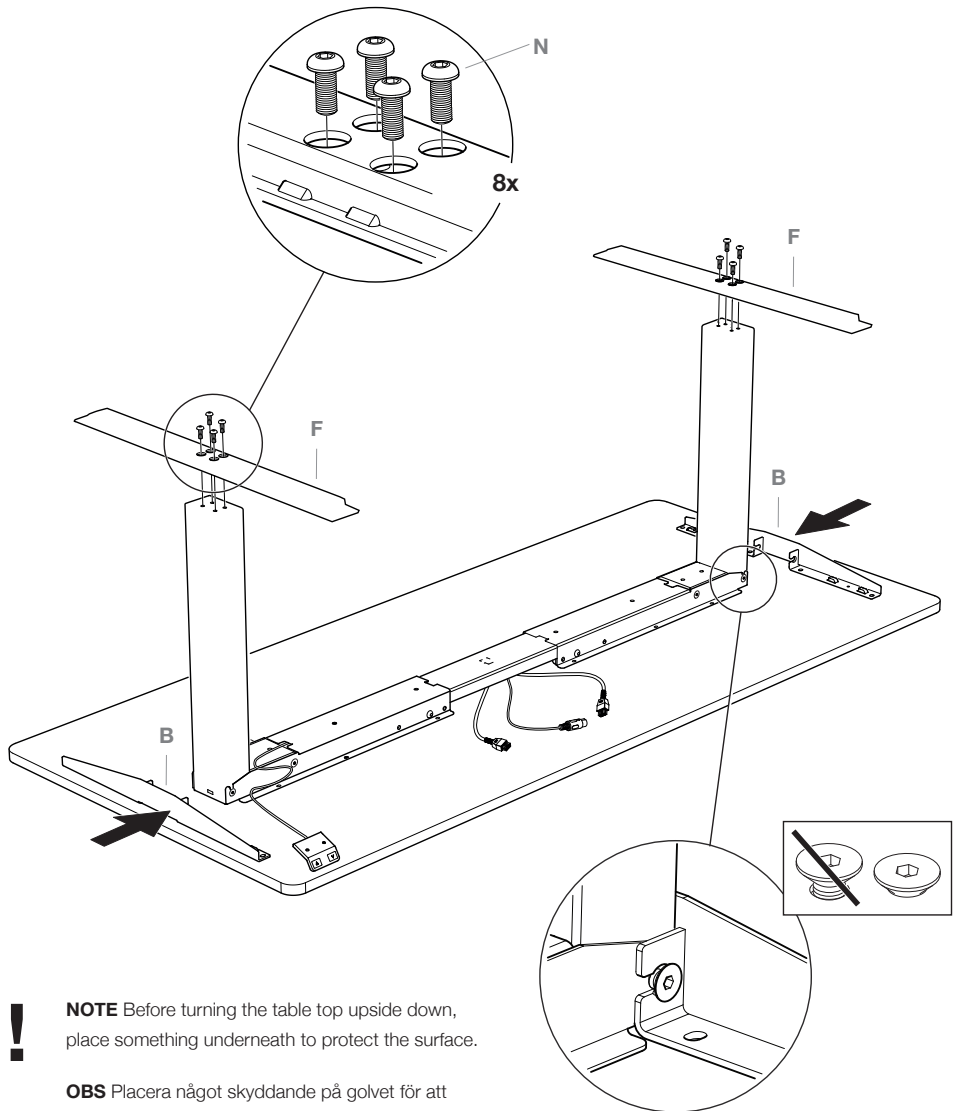

! **NOTE** Before turning the table top upside down, place something underneath to protect the surface.

OBS Placera något skyddande på golvet för att undvika skador på bordsskivan vid montering av stativ.

ACHTUNG Legen Sie zum Schutz der Tischplatte etwas unter bevor Sie diese zur Montage des Gestelles positionieren!

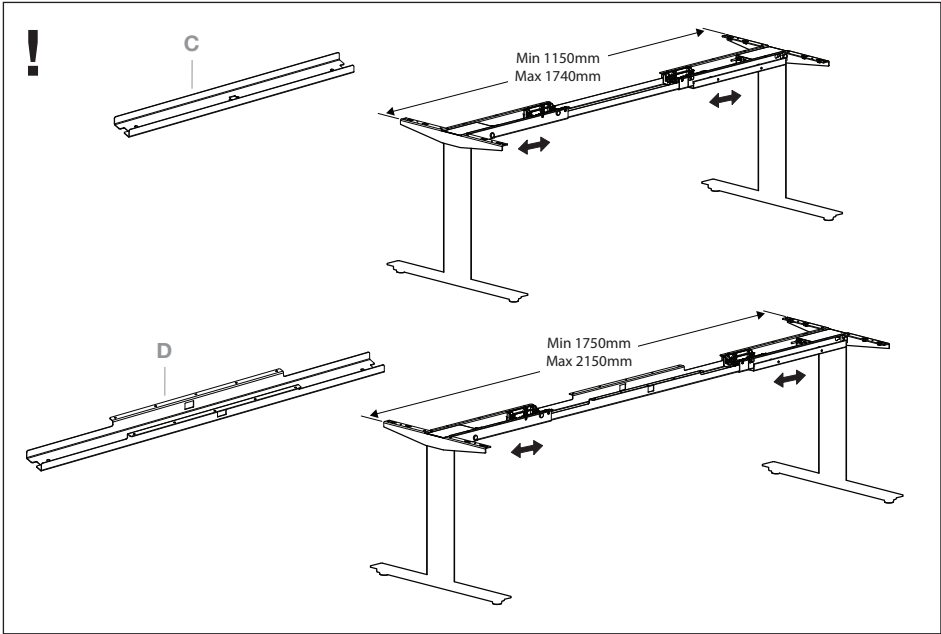

9:

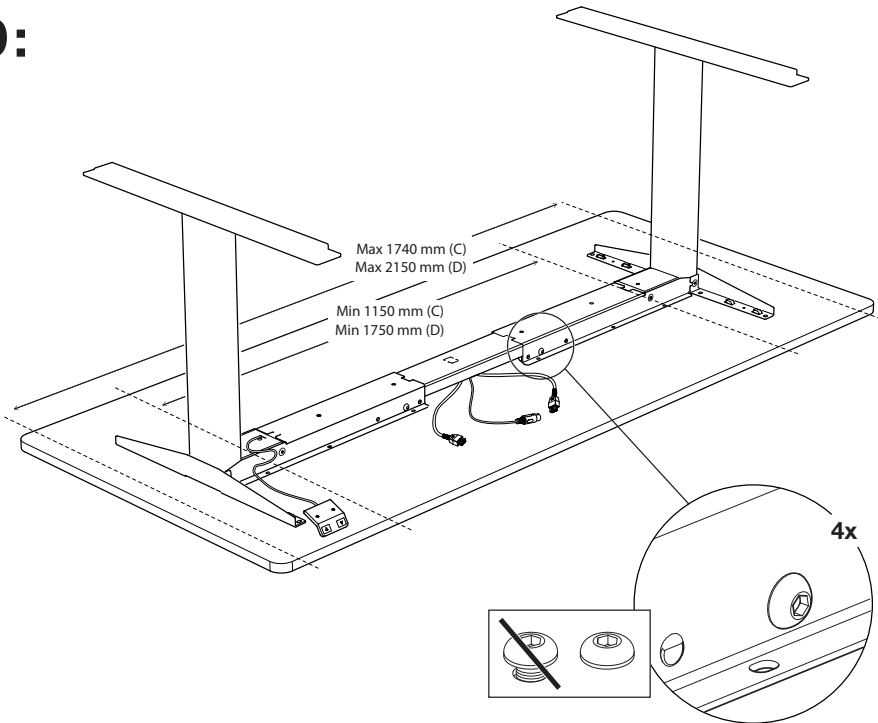

10:

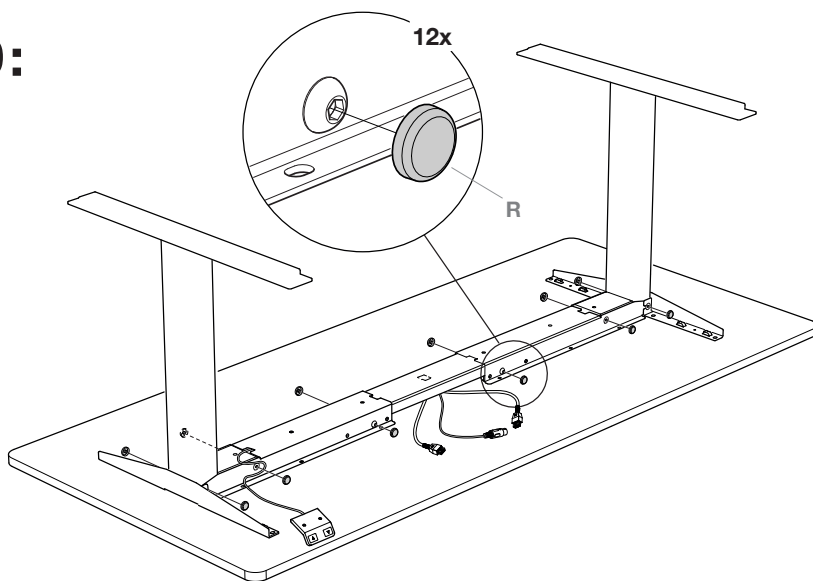

11:

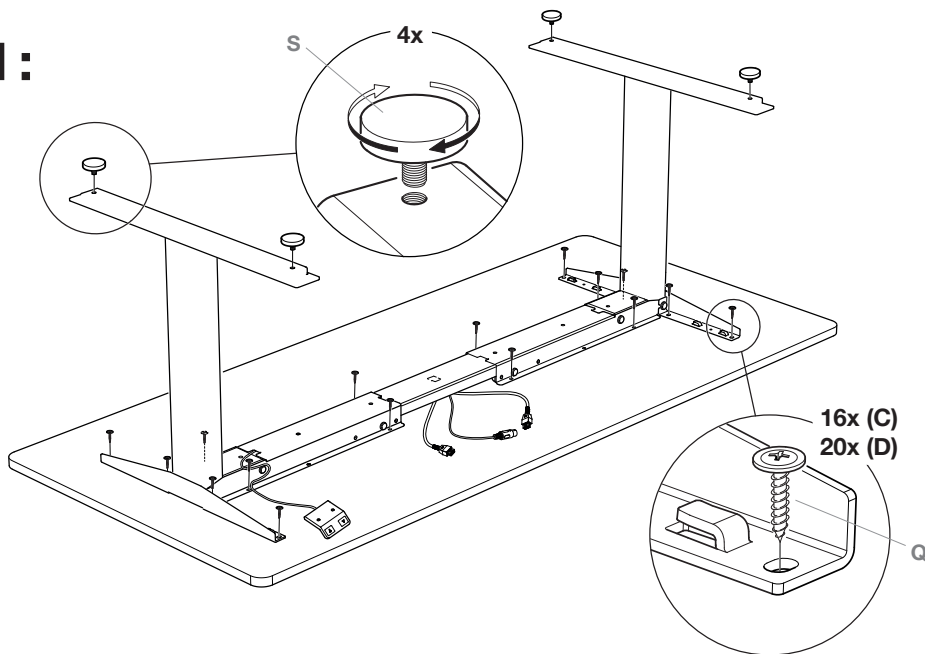

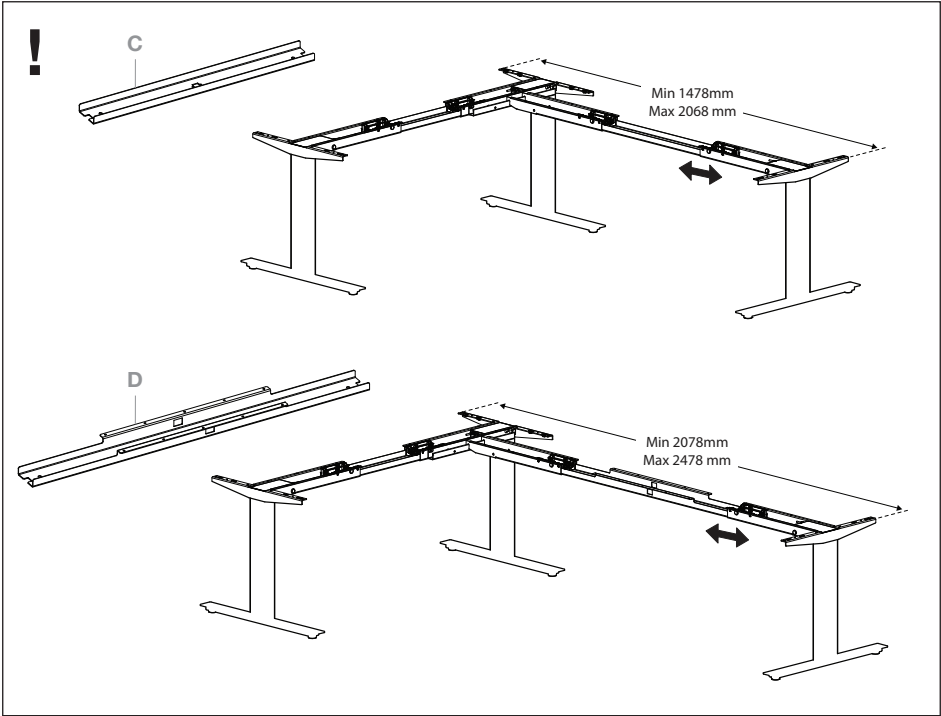

12:

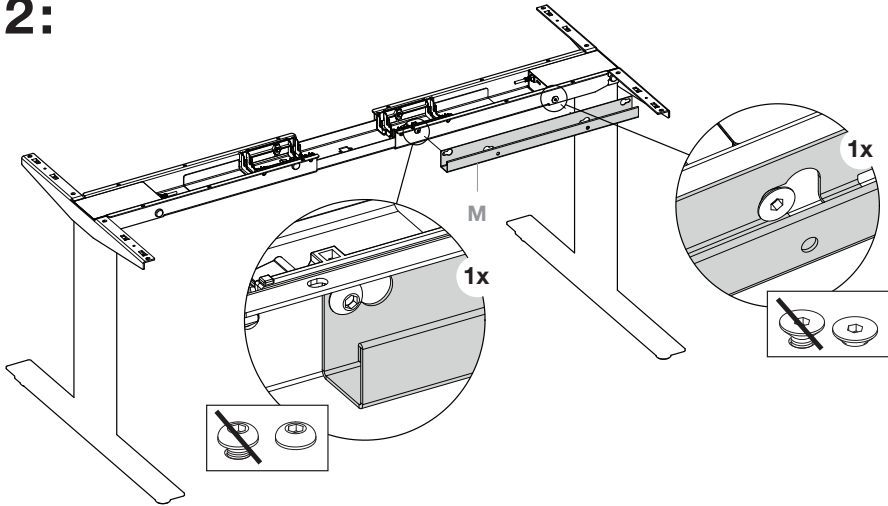

13:

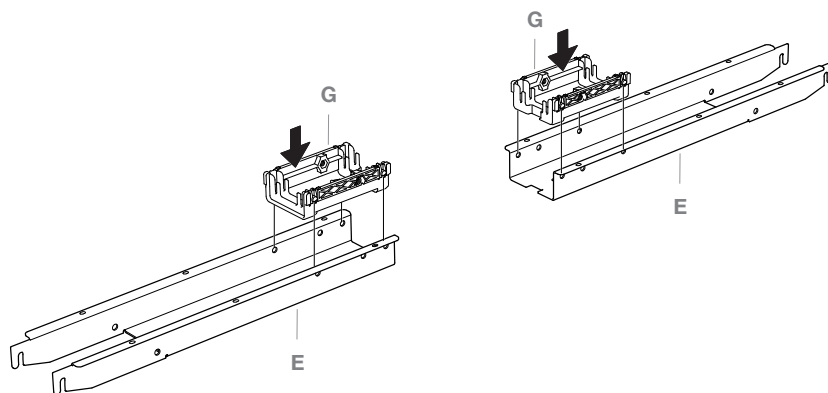
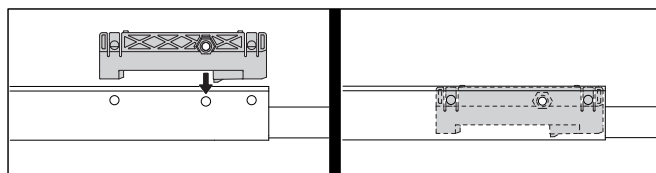

14:

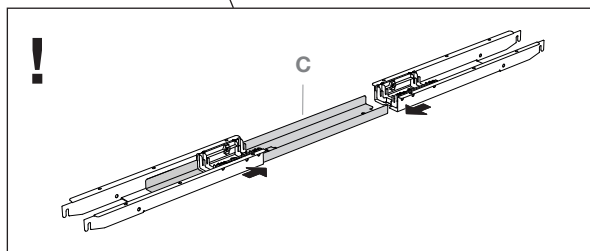
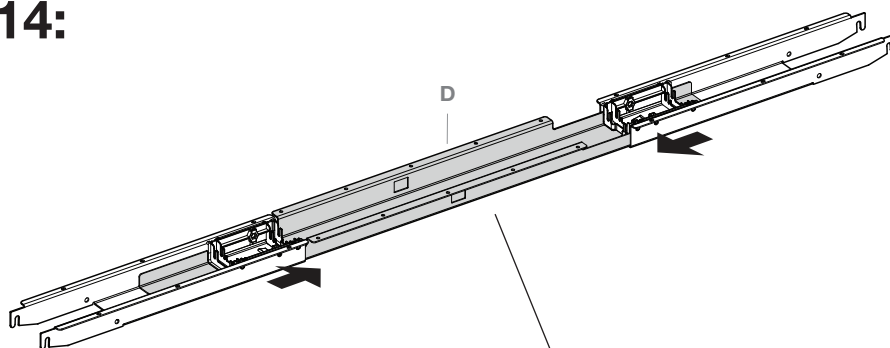

15:

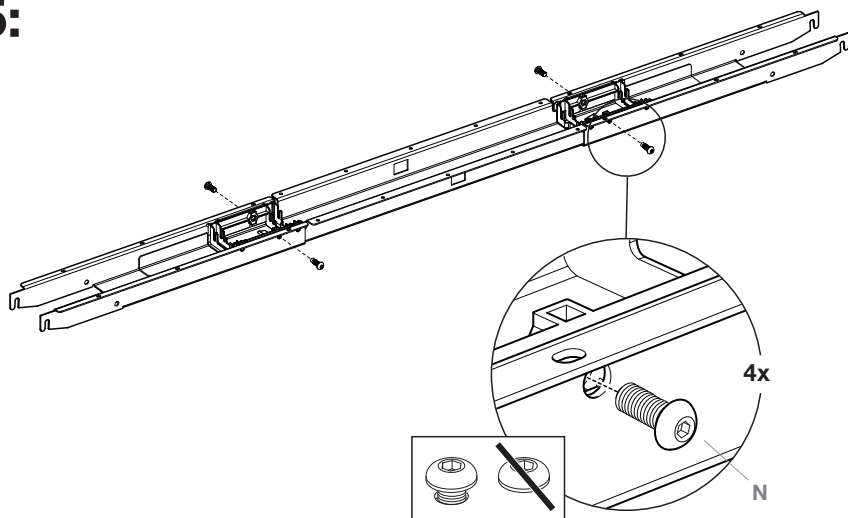

16:

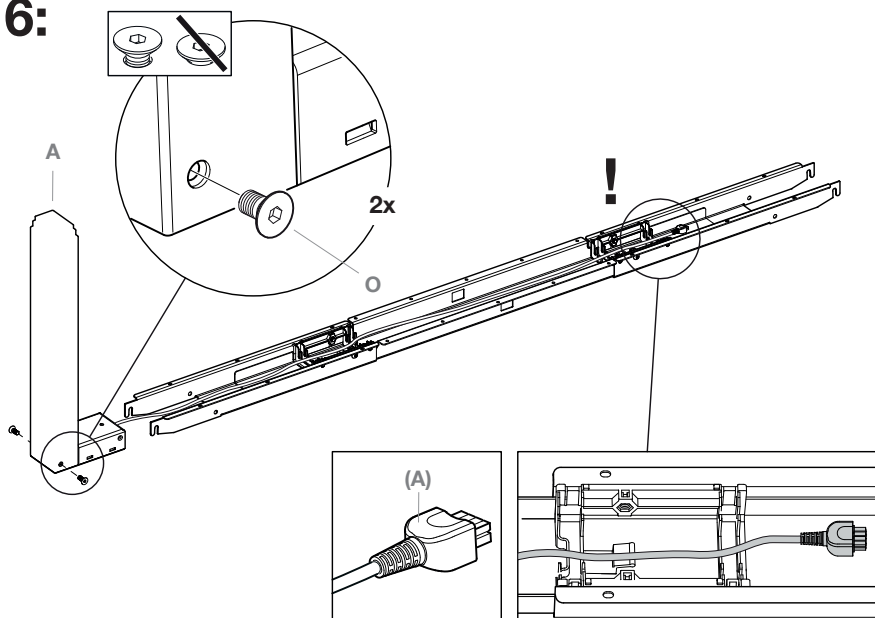

17:

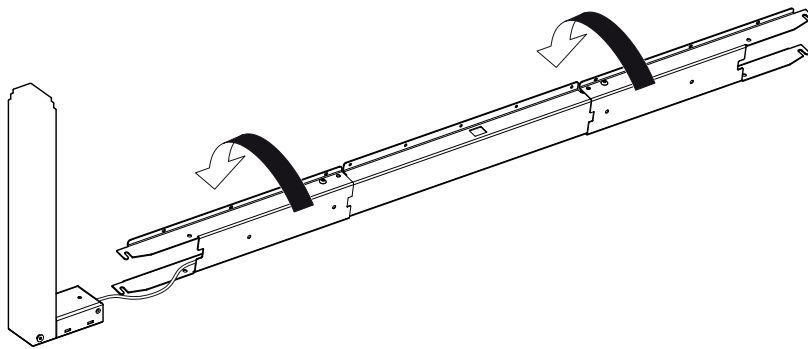

18:

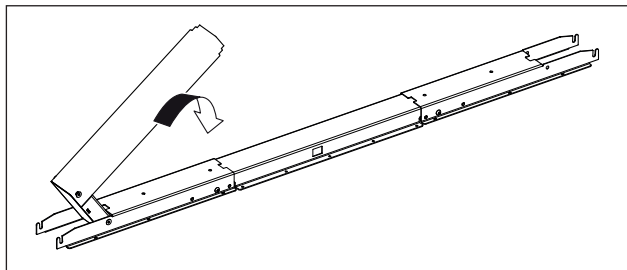
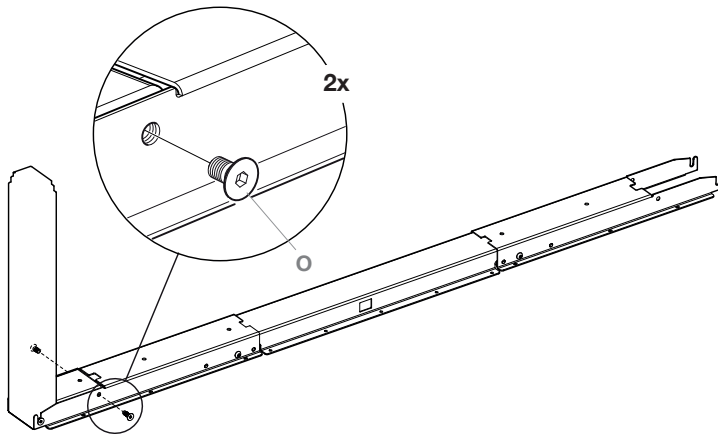

19:

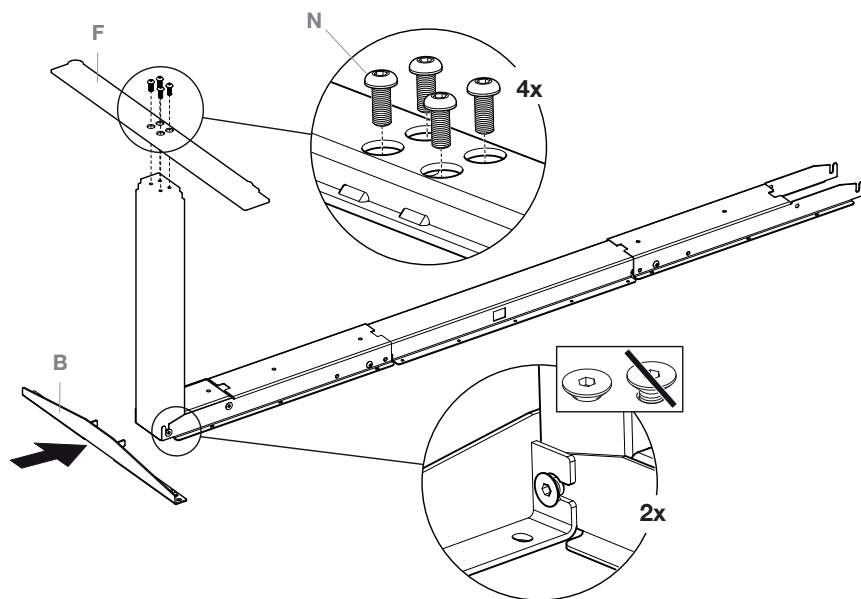

20:

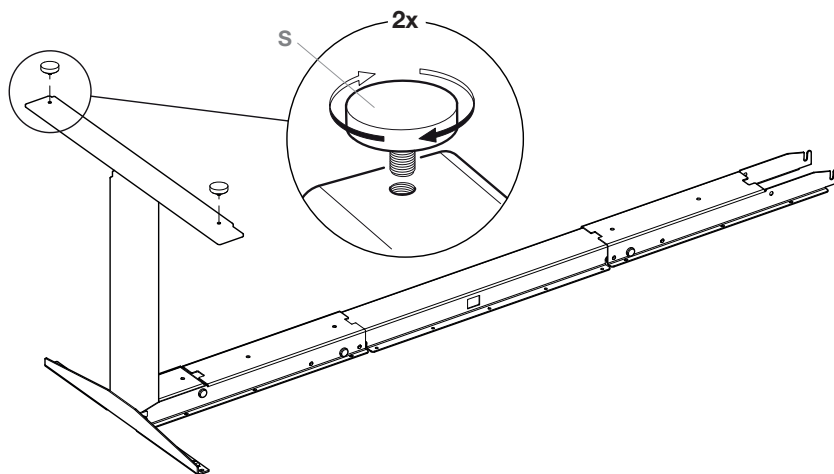

21:

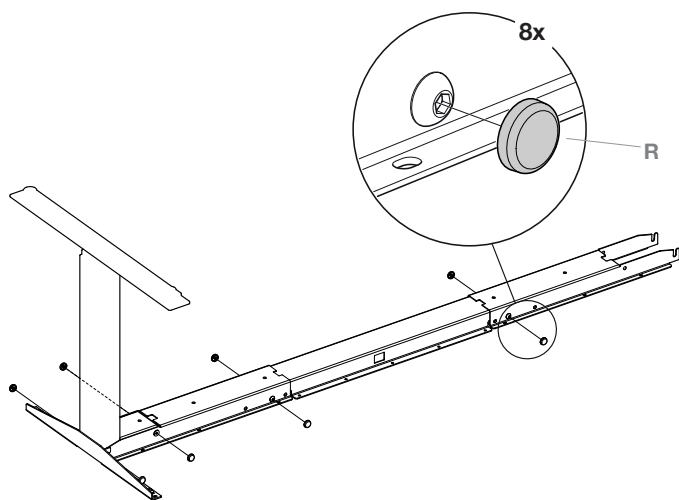

22:

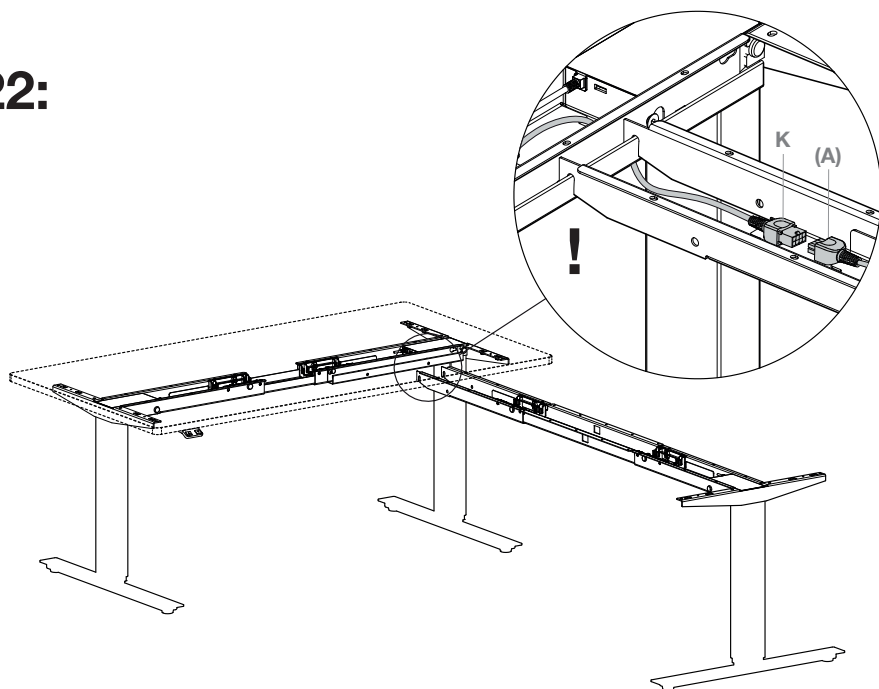

23:

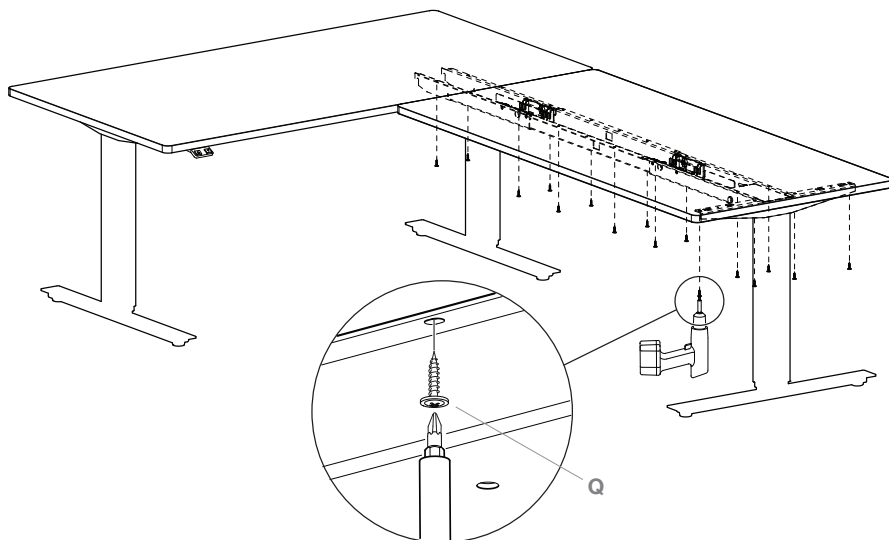

24:

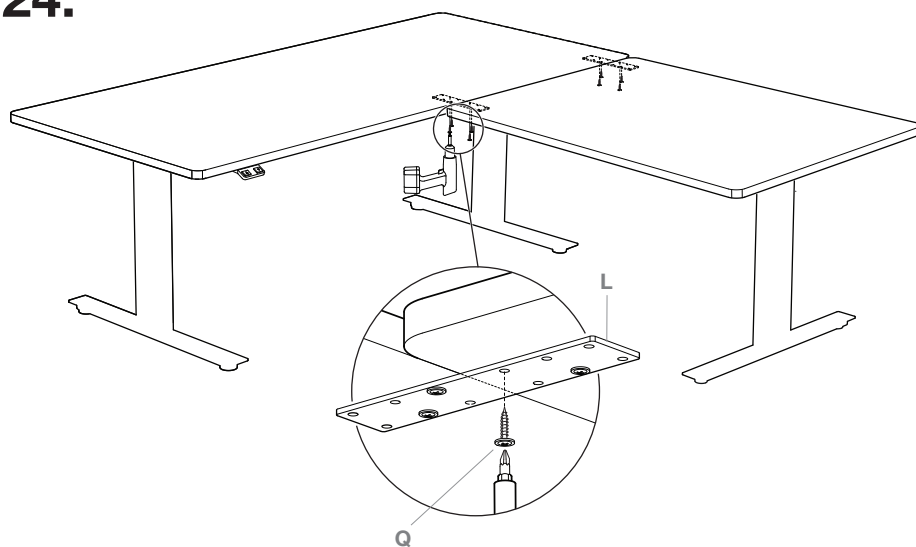

25:

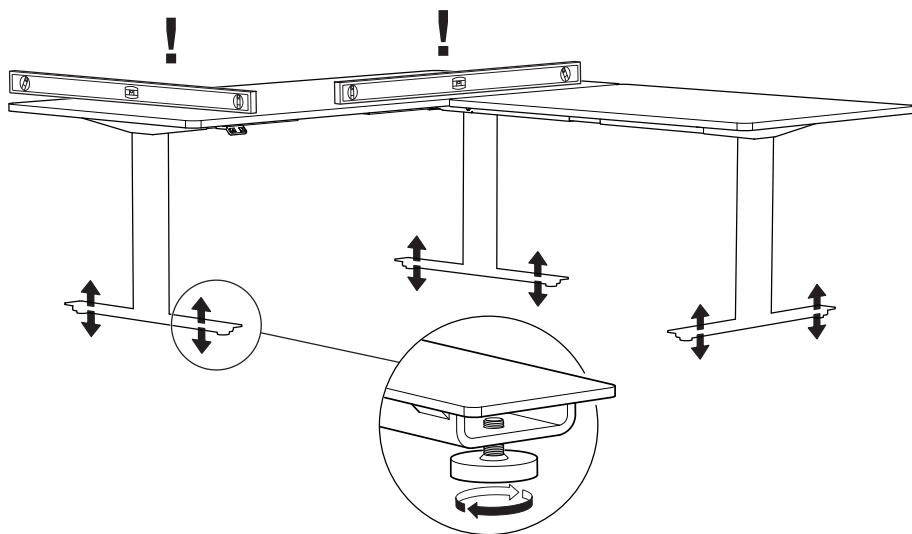

26:

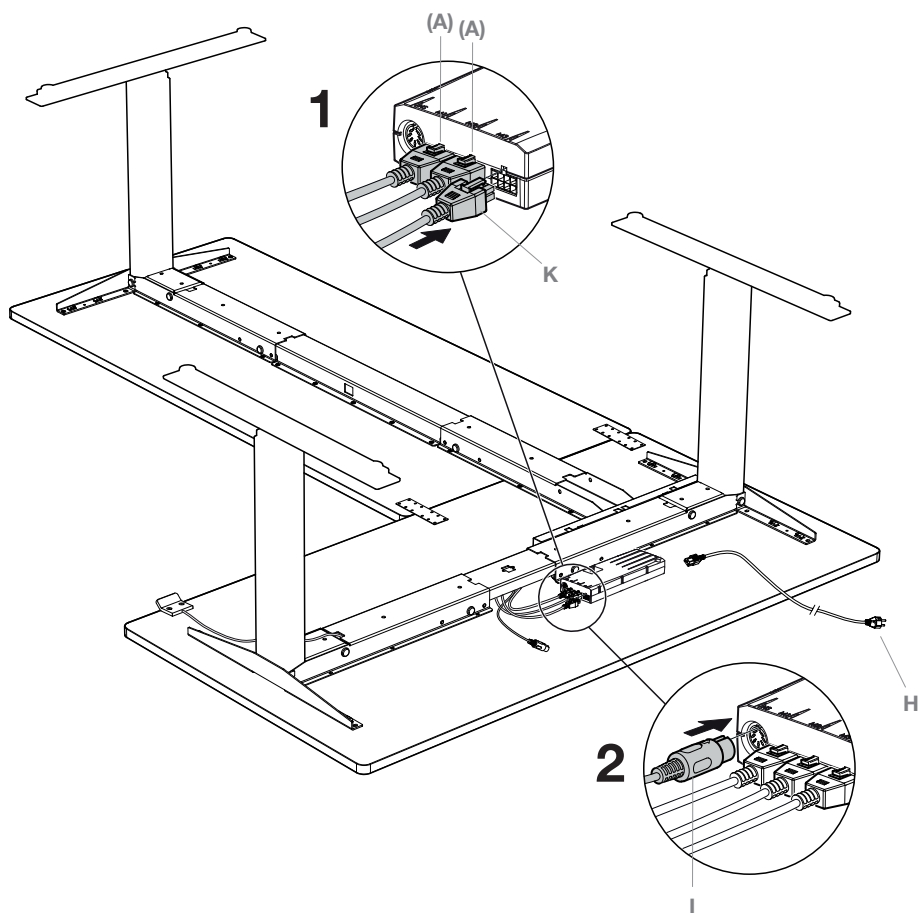

RESET PROCEDURE / NOLLSTÄLLNING / RESETTEN

EN

Lower the frame to its lowest position by pressing the down arrow on the hand control. Release the button. Press the button again and keep it pressed for 10 seconds, the reset is now carried out and the frame is ready to use.

SE

Kör bordet till stativets bottenläge genom att trycka på knappen "pil ned", när stativet nått lägsta läget så släpp knappen. Tryck sedan in den på nytt och håll inne ytterligare 10 sek. Stativet är nu nollställt och redo att användas.

DE

Fahren Sie die Tischplatte mit der Taste "Pfeil nach unten" zum tiefsten Punkt! Die Taste loslassen. Die Taste noch einmal herunterdrücken und sie ca. 10 Sekunden halten bis Sie eine kleine Bewegung der Tischplatte bemerken.

