



vango

VANGO DRUM THRONE *Instruction Manual*

Adjustable Height
Easy to Assemble

Padded Seat Cushion
Double-braced Legs



Content

Constructions of Drum Throne.....	1
Dimensions of Product.....	2
Installation Steps.....	3
Height Adjustment.....	4
Vangoa Drum Throne Bedienungsanleitung.....	5-8
Vangoa Drum Throne Instruction Manual.....	9-12
Vangoa Drum Throne Manual de instrucciones.....	13-16
Vangoa Drum Throne Manuale di istruzioni.....	17-20

Constructions of Drum Throne

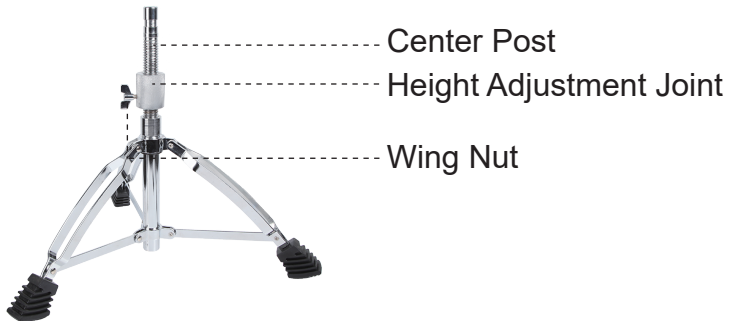
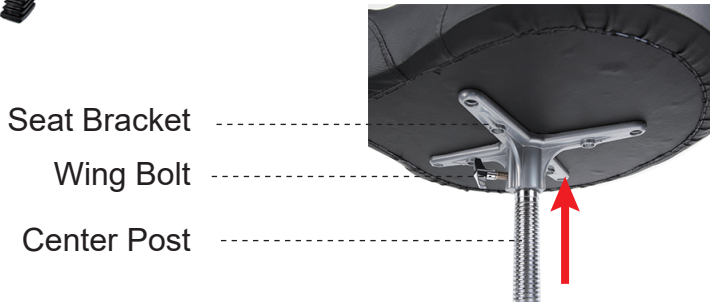

Dimensions of Product

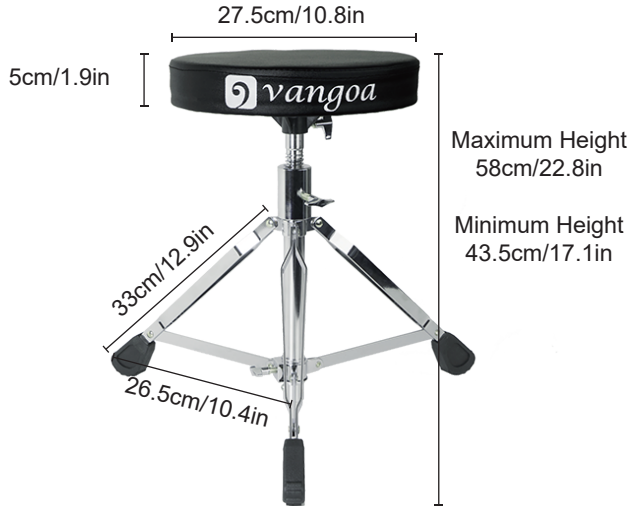

Installation Steps



※ Installation steps of two drum thrones are same.

Height Adjustment

Height Adjustment

1. Loosen the wing nut on the height adjustment joint.
2. Spin the center post until desired height is achieved.
3. Tighten the wing nut securely.



Note:

- When making adjustments to the adjustment knobs, be careful not to pinch your hands or fingers.
- Do not adjust the position of the bracket when seated as this may require twisting and reaching that can cause injury to your body. To prevent injury, make adjustments before sitting.

CAUTION

- Use caution when setting your Throne on uneven or slanted floors to prevent the Throne from tipping and causing possible injury to the user.
- The drum throne is intended for seating while playing drums and is not designed as a ladder, footstool or any other appliance other than its intended use.
- When folding the tripod legs, be careful not to pinch your fingers between the legs and stand.

Aufbauten des Trommelthrons

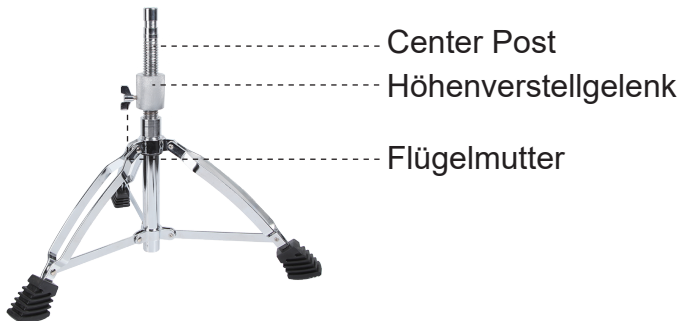
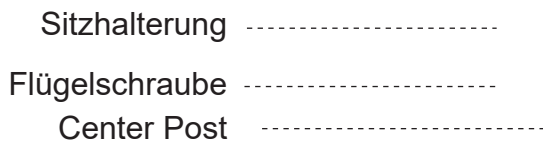
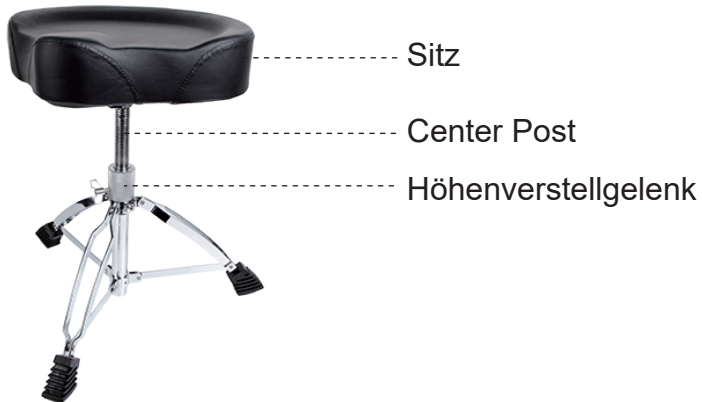

Produktabmessungen

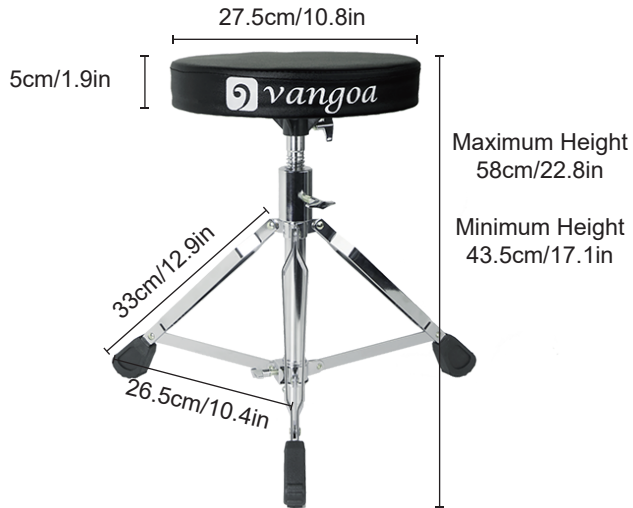

Installationsschritte



※ Installationsschritte von zwei Trommelthronen sind gleich

Höhenverstellung

Höhenverstellung

1. Lösen Sie den Flügel, der sich nicht am Gelenk zur Höhenverstellung befindet.
2. Drehen Sie den Mittelpfosten, bis die gewünschte Höhe erreicht ist.
3. Ziehen Sie die Flügelmutter fest an.



Hinweis:

- Achten Sie beim Einstellen der Einstellknöpfe darauf, sich nicht die Hände oder Finger einzuklemmen.
- Passen Sie die Position der Halterung nicht im Sitzen an, da dies ein Verdrehen und Erreichen erfordern kann, was zu Verletzungen Ihres Körpers führen kann. Nehmen Sie vor dem Sitzen Einstellungen vor, um Verletzungen zu vermeiden.

Vorsicht

- Gehen Sie vorsichtig vor, wenn Sie Ihren Throne auf unebenen oder schrägen Böden aufstellen, damit der Throne nicht umkippt und der Benutzer möglicherweise verletzt wird.
- Der Trommelthron ist zum Sitzen während des Schlagzeugspiels bestimmt und nicht als Leiter, Fußhocker oder Ameise für andere als die vorgesehene Verwendung bestimmt.
- Achten Sie beim Zusammenklappen der Stativbeine darauf, dass Sie nicht die Finger zwischen den Beinen einklemmen und stehen.

Constructions du trône du tambour



Support de siège -----
Boulon à oreilles -----
Poteau central -----

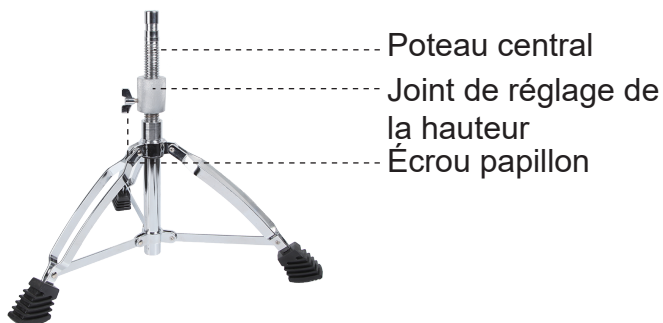

Dimensions du produit

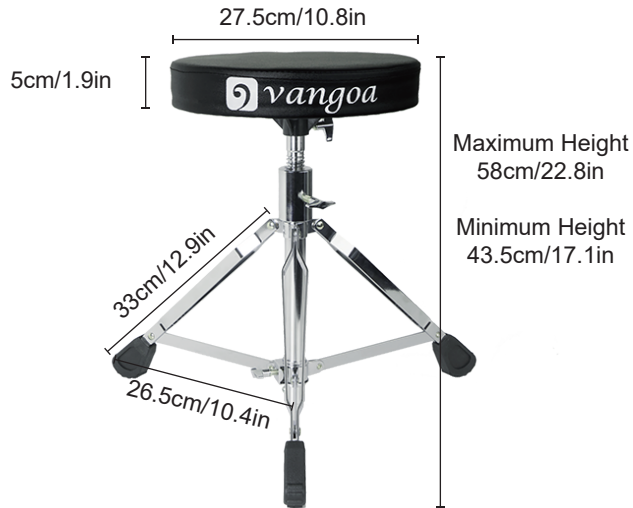

Étapes d'installation



✘ Les étapes d'installation de deux trônes de tambour sont les mêmes

Réglage de la hauteur

Réglage de la hauteur

1. Desserrez l'aile qui n'est pas sur le joint de réglage de la hauteur.
2. Faites pivoter le montant central jusqu'à ce que la hauteur souhaitée soit atteinte.
3. Serrez fermement l'écrou à oreilles.



Remarque:

- Lorsque vous ajustez les boutons de réglage, veillez à ne pas vous pincer les mains ou les doigts.
- Ne réglez pas la position du support lorsqu'il est assis, car cela pourrait nécessiter une torsion et une atteinte qui pourraient blesser votre corps. Pour éviter les blessures, effectuez les réglages avant de vous asseoir.

Mise en garde

- Soyez prudent lorsque vous installez votre Trône sur des sols inégaux ou inclinés pour empêcher le Trône de basculer et de blesser l'utilisateur.
- Le trône à tambour est conçu pour être assis pendant que vous jouez de la batterie et n'est pas conçu comme une échelle, un tabouret ou un autre appareil autre que son utilisation prévue.
- Lorsque vous pliez les pieds du trépied, veillez à ne pas vous pincer les doigts entre les pieds et le support.

Construcciones de trono de tambor



Asiento

Poste central

Junta de ajuste de altura

Soporte del asiento

Perno de ala

Poste central



Poste central

Junta de ajuste de altura

Tuerca de mariposa

Dimensiones del producto

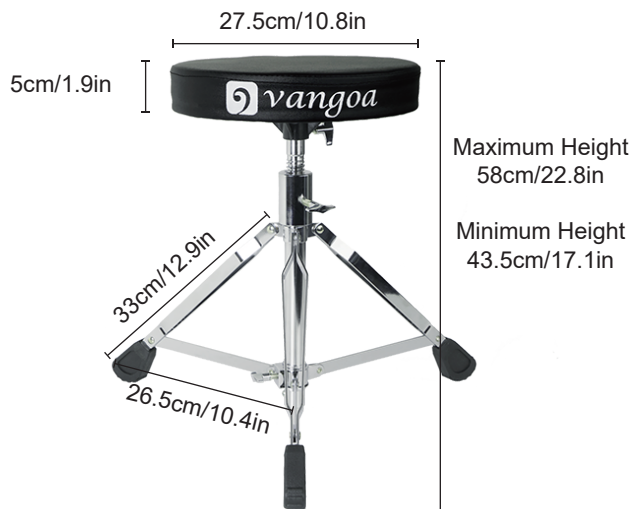

Pasos de instalación



✧ Los pasos de instalación de dos tronos de tambor son iguales

Ajuste de altura

Ajuste de altura

1. Afloje el ala que no está en la junta de ajuste de altura.
2. Gire el poste central hasta alcanzar la altura deseada.
3. Apriete la tuerca de mariposa de forma segura.



Nota:

- Al realizar ajustes en las perillas de ajuste, tenga cuidado de no pillarse las manos o los dedos.
- No ajuste la posición del soporte cuando esté sentado, ya que esto puede requerir torsiones y alcances que pueden causar lesiones a su cuerpo. Para evitar lesiones, haga ajustes antes de sentarse.

Precaución

- Tenga cuidado al colocar su Trono en pisos irregulares o inclinados para evitar que el Trono se vuelque y cause posibles lesiones al usuario.
- El trono del tambor está diseñado para sentarse mientras toca la batería y no está diseñado como una escalera, taburete u otro aparato que no sea su uso previsto.
- Al doblar las patas del trípode, tenga cuidado de no pillarse los dedos entre las patas y ponerse de pie.

Costruzioni di Drum Throne



Posto a sedere

Center Post

Giunto di regolazione
altezza

Staffa del sedile

Bullone ad alette

Center Post



Center Post

Giunto di regolazione
altezza

Dado ad alette

Dimensioni del prodotto

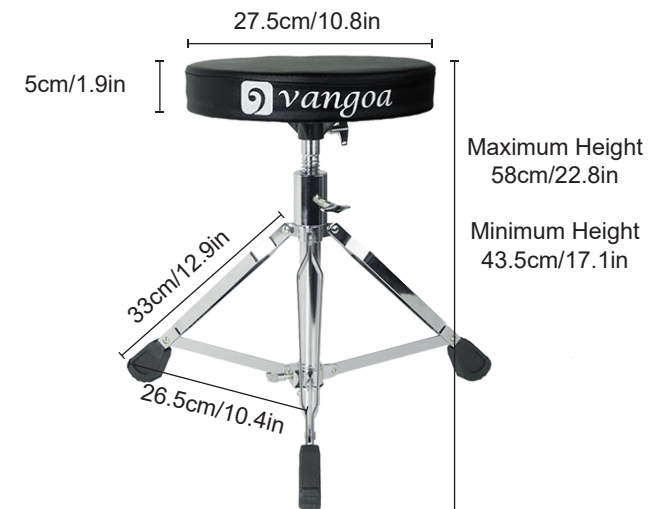

Passaggi di installazione



✘ Le fasi di installazione di due troni di batteria sono uguali

Regolazione altezza

Regolazione altezza

1. Allentare l'ala non sul giunto di regolazione dell'altezza.
2. Ruotare il perno centrale fino a raggiungere l'altezza desiderata.
3. Stringere saldamente il dado ad alette.



Nota:

- Quando si eseguono regolazioni alle manopole di regolazione, fare attenzione a non pizzicare le mani o le dita.
- Non regolare la posizione della staffa quando è seduto in quanto ciò potrebbe richiedere torsioni e allungamenti che potrebbero causare lesioni al corpo. Per evitare lesioni, effettuare le regolazioni prima di sedersi.

Attenzione

- Prestare attenzione quando si imposta il Trono su pavimenti irregolari o inclinati per evitare che il Trono si ribalti e causi possibili lesioni all'utente.
- Il trono di tamburi è progettato per sedersi mentre si suona la batteria e non è progettato come scala, poggiatesta o altri apparecchi diversi dall'uso previsto.
- Quando si piegano le gambe del treppiede, fare attenzione a non pizzicare le dita tra le gambe e il supporto.



INSTRUCTION

Manual

If you have any questions about the product, please feel free to contact us:

Website: www.vangoa.com

Customer Support Email: cs@vangoa.com

Made in China

Join us!

Facebook: [@vangoaofficial](https://www.facebook.com/vangoaofficial)

Instagram: [@vangoa_music](https://www.instagram.com/vangoa_music)

YouTube: [Vangoa Music](https://www.youtube.com/VangoaMusic)



@vangoaofficial



Vangoa Music User Group