

TIME & STYLE

Assembly instructions

Tourou 1

Tourou 2

Components

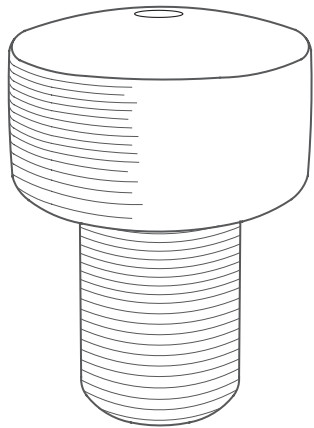

Shade

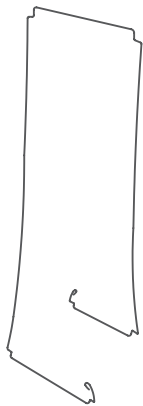

Lamp harp

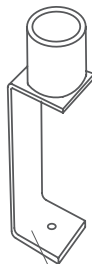

U-Shape mounting bracket

Socket



Wrench



Screw

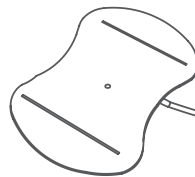

Base

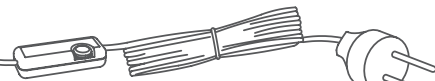

Power cord
with dimmer switch

1 Install the U-Shape mounting bracket to the base

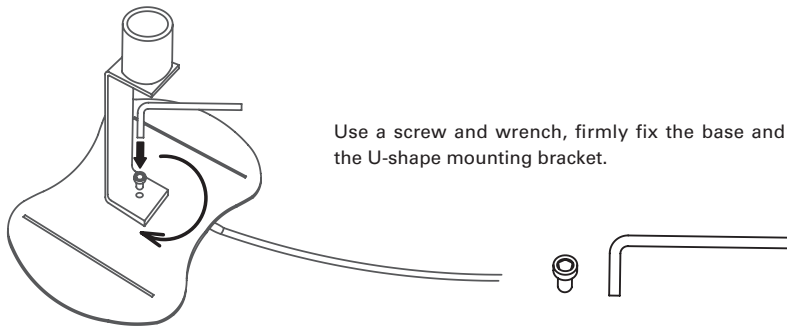

2 Install the lamp harp to the base

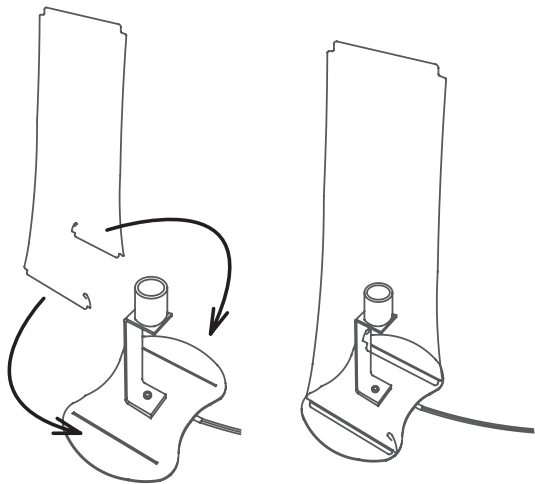

While pressing the lower part of the harp from the side, insert it into the groove of the base plate.



When the bottom of the harp is closed, insert the harp.

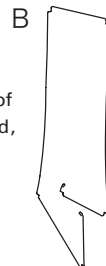

If the bottom of the harp is open, cross the harp and bend it to A state, then insert the harp.

Attention: please make sure the shape is correct as shown in A below. Otherwise it may be less durable.

3 Install the bulb (not included)

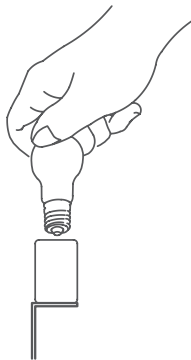
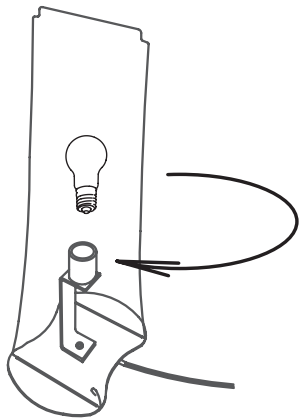

Place the light bulb into the socket and screw it in firmly.

4 Install the shade

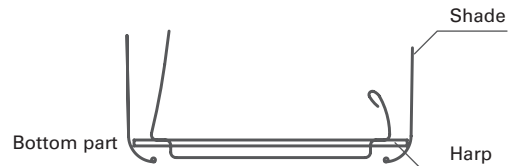
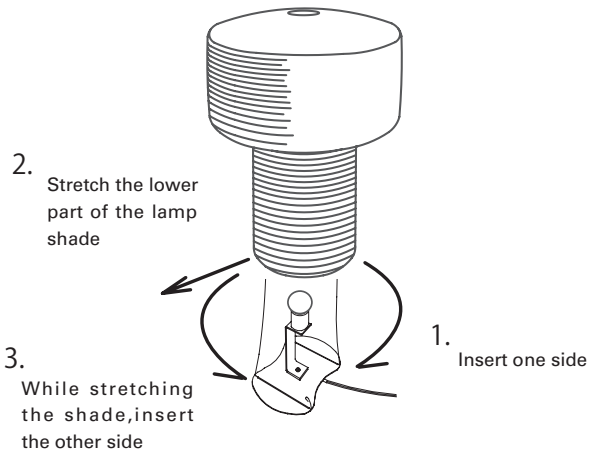

Insert the harp into the opening on the top of the shade, attach the bottom by hooking it onto the base plate.

*Hook the shade on one side of the base plate, and stretch the other bottom part of the shade. Then insert the other side.

5 Using dimmer switch

Finish

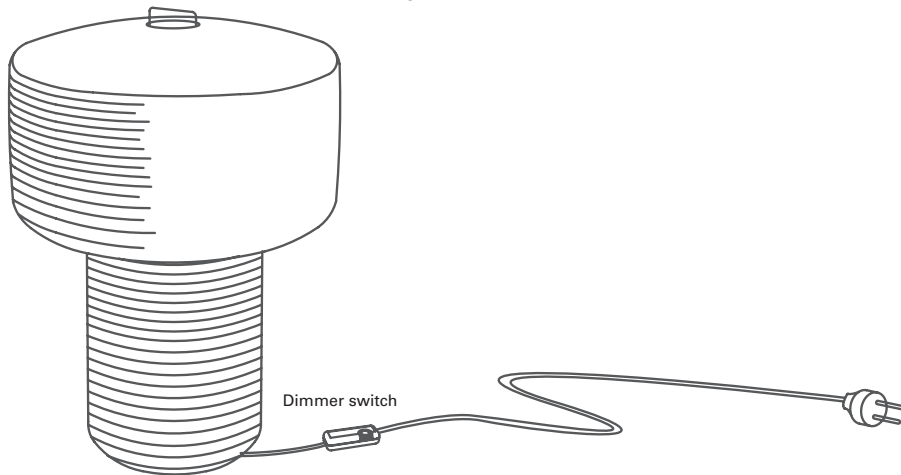

By sliding the dimmer button, you can control the amount of light.

Note: Please handle the shade carefully.

Attention

- If you do not install the equipment properly according to the instructions, there is a risk of injury due to fire, electric shock, or damage.
- If you feel any abnormality, turn off the power immediately. After confirming that the abnormality has subsided, contact an electrical contractor / dealer or customer service.
- If you use a lamp with a specified wattage (W) or more, there is a risk of fire or malfunction.
- Do not improve the equipment or replace parts. There is a risk of fire, electric shock, malfunction, etc.

Prestige Japan Inc. / Customer service

Tel +81 (0)3 5464 3208

E-mail int-info@timeandstyle.com