

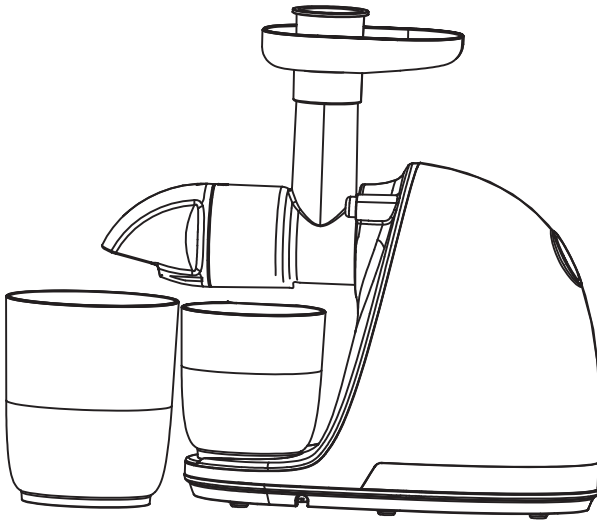

Instruction Manual
Slow Juicer
ZM1501



**PLEASE READ INSTRUCTIONS CAREFULLY BEFORE ASSEMBLY
RETAIN THIS MANUAL FOR FUTURE REFERENCE**

Content

Section I. Precautions for Safety Use.....	4
Section II. Parts and Functions.....	6
Section III. Method of Operation.....	8
Section IV. How to assemble.....	9
Section V. Tips for Ingredients Selection.....	13
Section VI. Maintenance.....	15
Section VII. Safety Index.....	17
Section VIII. Trouble Shooting.....	17
Section IX. Warranty.....	19

Parts and Functions

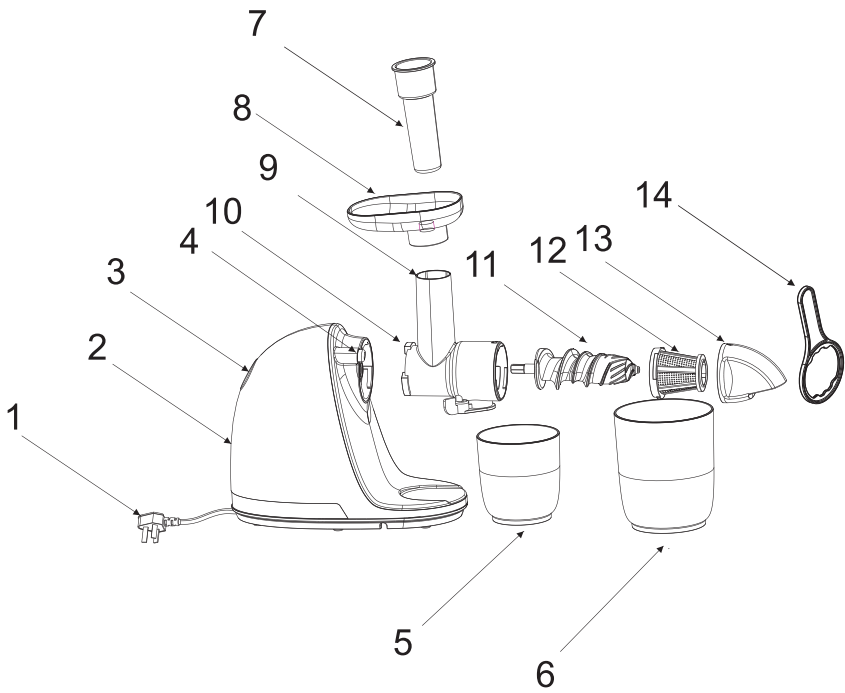

Section I. Precautions for Safety Use

When using electrical appliances, basic safety precautions should always be followed, including the following:

1. Power of 120V~60Hz shall be supplied to this product. Please confirm your power supply before use.
2. Be sure to disconnect the power supply before dis-assembly/re-assembly or adjustment to this product.
3. In case of any damage to the flexible wire, to avoid any hazard, contact our customer service or send it to our authorized service center for replacement, and do not try to disassemble it without our authorization.
4. Prior to use, please check the power cable, plug, juice filter, Auger, chopper body, meat grinder and other parts, and in case of any damage, stop using this product and contact our customer service immediately without unauthorized dis-assembly or repair to avoid any potential hazard.
5. For need of any repair during use, return appliance to our authorized service facility for examination, repair or electrical adjustment.
6. Before connecting with power supply, make sure that any such removable parts as extractor body, auger, juice filter and extractor cover have been mounted in place.
7. DO NOT put your fingers or other objects into the juicer opening while it is in operation. If food becomes lodged in the opening, use the plunger or another piece of fruit to push it down. When this method is not possible, turn the motor off and disassemble juicer to remove the remaining food.

8. The food material needs to be cut into proper pieces so as to pass through the inlet to extractor/chopper/grind. Any fruit/vegetable shall have any hard core, seed, skin or shell removed before processing.
9. Proper amount of force shall be used to push the food material in, not excessive but sufficient to have it cut off exactly.
10. The juice filter, extractor cover, or auger may be dyed by the juice during operation, which is a normal phenomenon and has no effect on edibility and does no harm to health.
11. This product is equipped with intelligent protection chips, making it stop automatically for every 20 minutes' operation. And in such case, rest it for 20-30 minutes before restarting it, so as to cool the motor down and prolong product servicelife.
12. This product is designed to limit the flow rate. During processing of any hard material, the motor will be locked and the current will rise up. When the current goes higher than 1.3A, the equipment will beep and the motor will stop operation for over-current protection and extension of life span.
13. In case that current limit protection is triggered or the motor is locked and stops automatically, disconnect the power supply and keep the switch in position "0", and press Rotate Backwards button on the power switch, and then discharge the food material and then press Rotate Forwards to restart the machine. If the problem continues, it is recommended to remove any food material inside auger before restart so as to protect the motor.
14. After the completion of operation, remove any removable part only after the motor/auger/shredder/slicer/grinder screw has stopped rotating and the power has been disconnected.
15. Any part in contact with food material is clean, safe and reliable in compliance with related food hygiene codes.
16. To protect against risk of electrical shock, do not put the motor base in water or other liquid.

17. Do not use any steel wool, abrasive cleaning agent or corrosive liquid such as gasoline or acetone to clean this product.
18. This product should be stored in a place that children can't reach. Not allow persons with unsound extremities and sensation or mental disorders and persons who are short of related experience and knowledge(including children) to use or play with this product.
19. This product is used for individual or family only.
20. This product is of Class-I protection grade, and the socket used for it must be grounded properly.

Section II. Parts and Functions

No.	Component Name	Function Description
①	Power Cable	For connection to power supply.
②	Housing	The main unit containing motor and other components, providing power output.
③	On-Off Switch	For control of product operation, such as forward/backward rotation and close-down.
④	Locking Button	For locking of extractor to prevent unexpected release out of the housing. To unload the extractor off the housing, press down and hold this button.

⑤	Juice Container	To hold and collect the juice extracted by the extractor.
⑥	Pulp Container	To hold and collect any Pulps separated by the extractor.
⑦	Plunger	To squeeze and make the load food material contact completely with the auger so as to maximize extracting efficiency.
⑧	Tray	For interim storage of food material to process.
⑨	Feed chute	Feeding food and load down to Drum
⑩	Drum	One of the main components to extract juice, where the food material is loaded from the Feed chute at the top, while the juice and Pulps are discharged from the outlet.
⑪	Auger	One of the main components to extract juice, where the food material is transferred and ground against juice filter or extruder.
⑫	Juicing screen	Work with Auger to grind food material and filter the juice. (applicable to fruits, vegetables and beans)
⑬	End cap	Coupled with extractor to provide protection.
⑭	Wrench	Please use this wrench to remove the juicer cover in clockwise direction if you find the juicer cover is difficult to remove after juicing.

Section III. Method of Operation

Prior to first use, Please thoroughly clean any parts in contact with food material. (See Section IV. Maintenance for more details)

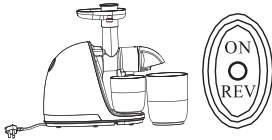

Button Operation

Description: "ON" :
Appliance is ON state

"ON" : Appliance is OFF state

"REV" : Appliance will REVERSE auger.(use when food is blocking or stuck)

Tips: In case of Pulp blockage or motor locking. Press and hold "R" button for approximately 3 seconds to rotate the auger reversely and then release it.. Press "ON" button to resume normal operation.

Section IV. How to assemble

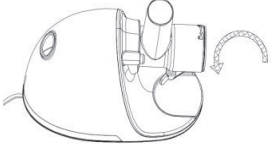
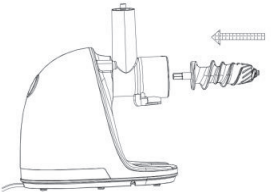
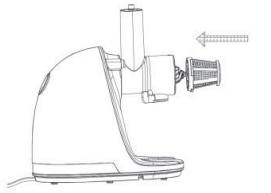
	1	<p>Connect Drum⑩with Housing②:</p> <p>Connect the Drum⑩with the Housing② by aligning the“▼” on Feed chute⑨ with “🔒” on the Housing②, push the Drum hard and rotate the Drum anticlockwise until aligning“▼” on Feed chute⑨ with “🔒” on the Housing②. (You will hear “Tick” sound to confirm fasten it tightly and correctly).</p>
	2	<p>Place the auger⑪into the drum⑩.</p>
	3	<p>Insert the juicing screen⑫ into the drum⑩.</p>

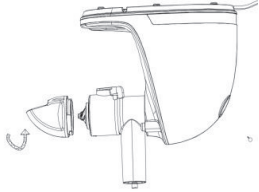
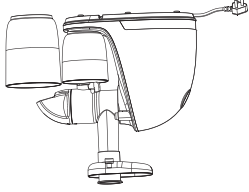
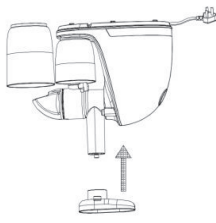
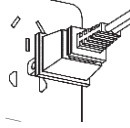
<p>4</p> <p>Place the end cap 13 onto the drum 10 end and rotate the cap counter-clockwise.</p>	
<p>5</p> <p>Place Juice Cup 5 and Pulp Container 6 under the drum set.</p>	
<p>6</p> <p>Mount tray onto the upper end of Feed chute 9.</p>	
<p>7</p> <p>Connect to power supply and get ready for start up. (Before power-on, make sure the switch is in Off position.)</p>	

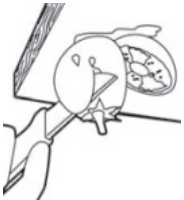
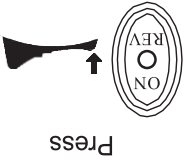
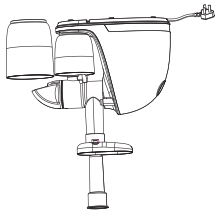
<p>8</p> <p>Clean the material and cut it into pieces small sufficiently which can pass through the Feed chute, and place them onto the tray.</p> <p>Note: Any hard core, seed, skin or shell from fruits and vegetables shall be removed in advance.</p>	
<p>9</p> <p>Press down "ON" button on the switch to start the motor.</p> <p>Note: Keep the machine operating for less than 10 minutes. Long time work will destroy the motor.</p> <p>Note: Do not touch the power switch with wet hand to avoid electric shock, leakage or fire.</p>	
<p>10</p> <p>Place the few pieces of cut fruit or vegetables into the Feed chute, push them down the drum gently with plunger.</p> <ul style="list-style-type: none"> • Proper amount of force shall be used to push the food material in, not excessive but sufficient to have it cut off exactly. <p>(Do not put your finger or any other object into the Feed chute! If the Pulp/Juice Cup is full, disconnect the power supply and clear it up before restart.)</p>	
<p>Upon completion, shut down the switch when no juice flows out of the outlet and disconnect the power supply. Do not remove the Juice Cup off the outlet until the spiral propeller and juice filter have stopped rotating completely.</p>	

	11	<p>The extracted juice should be drunk as soon as possible as it will have degraded taste and nutrient content if exposed in the air for a time.)</p> <ul style="list-style-type: none">• The Pulps shall not be stored for a long time. <p>Do not touch the power switch with wet hand to avoid electric shock, leakage or fire.</p>
---	----	---

Manufacturer:

Zhongshan Jimi Electrical Appliance Co., Ltd.

No. 2, Yucheng 2nd Road, Xiaolan Town, Zhongshan City, Guangdong China.

Section V. Tips for Ingredients Selection

- **FRUIT JUICE EXTRACTOR**

Efficiently juices hard and soft fruits: even citrus fruits, usually one of the hardest fruits to juice.

Jam can not be achieved, some fruit can not squeeze juice (such as bananas, mangoes, dried fruit, sugar cane, etc.).

- **VEGETABLE JUICE**

Cut vegetables to strips(less than 4inch/10cm) .

Juices all kinds of vegetables including carrots, beets, celery, peppers, and radishes without destroying the natural flavor and nutrition benefits.

Fresh taste and full nutrition are guaranteed with this unique extraction process.

- **WHEATGRASS AND LEAFY GREENS**

Cut it to strips(less than 4inch/10cm) .

Wheat grass, kale, cabbage, spinach and pine tree needles are just some of the natural products that can be juiced with the Amzchef juicer. Enjoy the best that nature offers in raw foods of all kinds and juice them for full nutritional benefits.

Instructions on Selection of Fruits

1. Select fresh fruits and vegetables, which contain more juice. The proper fruits include: pineapple, beet root, celery stalk, apple, cucumber, spinach, melons, tomato, orange and grape.

2. Thick skin on fruits such as orange, pineapple and raw beet root instead of thin skin on fruit/vegetable needs to be removed. Seeds in oranges should be removed as well, which may make the juice taste a little bitter.
3. Concentration of juice extracted from apple depends on what type of apple is selected. Juice extracted from juicier apple is less thick, so select the proper type of apple depending on your desired juice concentration.
4. Just extracted apple juice will turn brown very soon, and this process can be slowed by adding drops of lemon juice into it.
5. Leaves and stems (such as those of lettuce) can be put into the extractor to extract juice.

The typical nutrient ingredient contained in fruits/vegetables are shown below:

Fruit/Vegetable	Vitamin/Mineral	Calorie
Apple	Vitamin C	0.44LB (200g) =150KJ(72 calorie)
Apricot	Dietary fiber and potassium	0.07LB (30g) =85KJ(20 calorie)
Beet	Folic acid, dietary fiber, Vitamin C and potassium	0.35LB (160g) =190KJ(45 calorie)
Blueberry	Vitamin C	0.28LB (125g) =295KJ(70 calorie)
Brussels Sprouts	Vitamins C, B, B6 and E, folic acid and dietary fiber	0.22LB (100g) =110KJ(26 calorie)
Cabbage	Vitamin C, folic acid, potassium, Vitamin B6 and dietary fiber	0.22LB (100g) =110KJ(26 calorie)
Carrot	Vitamins A, C and B6, and dietary fiber	0.22LB (100g) =110KJ(26 calorie)

Celery	Vitamin C and potassium	0.18LB (80g) =55KJ(7 calorie)
Cucumber	Vitamin C	0.62LB(280g)=120KJ(29 calorie)
Fennel	Vitamin C and dietary fiber	0.66LB(300g) =145KJ(35 calorie)
Grape	Vitamins C and B6, and potassium	0.28LB(125g) =355KJ(85 calorie)
Yangtao	Vitamin C and potassium	0.22LB(100g)=100KJ(40 calorie)
Muskmelon	Vitamins C and A, folic acid and dietary fiber	0.44LB(200g)=210KJ(50 calorie)
Nectarine	Vitamins C and B3, potassium and dietary fiber	0.4LB(180g) =355KJ(85 calorie)
Peach	Vitamins C and B3, potassium and dietary fiber	0.33LB(150g)=205KJ(49 calorie)
Pear	Dietary fiber	0.33LB(150g)=250KJ(60 calorie)
Pineapple	Vitamin C	0.33LB(150g)=245KJ(59 calorie)
Raspberry	Vitamin C, iron, potassium and magnesium	0.28LB(125g)=130KJ(31 calorie)
Tomato	Vitamins C, E and A, dietary fiber and folic acid	0.22LB(100g)=90KJ(31 calorie)

Section VI. Maintenance

1. Before cleaning this product, be sure to shut down the switch to disconnect the power supply.
2. Clean this product after using it.
3. The Housing cannot be washed under water, and must be cleaned with twisted wet cloth instead.

4. Before storing it, make sure this product is clean and dry.
5. Disassemble this product to wash the components by the following steps:

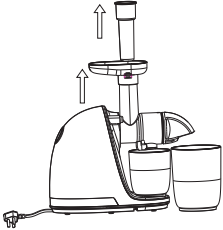
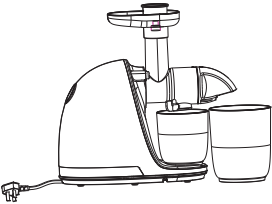
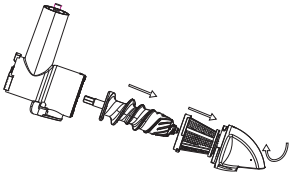
	<p>1</p>	<p>First remove the plunger and tray.</p>
	<p>2</p>	<p>Press down and hold the locking button④, and rotate the drum clockwise to remove it.</p>
	<p>3</p>	<p>After removing extractor, detach the end cap, juice screen and auger in turn, all removable components can be washed with water.</p>

WARNING

Do not immerse the motor base in water or any other liquid. Do not use water jet to clean the motor base.

Section VII. Safety Index

Product Name	Slow Juicer
Model	ZM1501
Rated Voltage	120V ~
Rated Power	150W
Rated Frequency	60Hz
Continuous Operating Time	≤10 minutes
Interval Time	≥10 minutes

Section VIII. Trouble Shooting

Fault Phenomenon	Analysis of cause	Fault resolution
-------------------------	--------------------------	-------------------------

<p>After connecting power supply and turning on the switch, the product fails to work</p>	<ol style="list-style-type: none"> 1. After turn on the machine, wait for 1s, it will work. It is normal. 2. After 1s, it still no work, maybe poor contact between plug and socket 	<p>Re-plug it properly</p> <ol style="list-style-type: none"> 1. Replace the socket and try again, or contact after Sales Support Email: info@iamzchef .com
<p>During the early uses, the motor generates unpleasant smell</p>	<p>It is a normal phenomenon</p>	<p>If this phenomena occurs frequently, send it to our authorized service center nearest to you for inspection.</p>
<p>This machine stop during operation</p>	<ol style="list-style-type: none"> 1. Too low voltage 2. Excessive amount of food material has been loaded 3. The machine has operated continuously for long time. 	<ol style="list-style-type: none"> 1. Check whether the voltage is too low 2. Disconnect the power supply and remove excessive food material 3. It is a normal phenomenon and the motor will resume after a break time.
<p>Noise is generated during operation.</p>	<ol style="list-style-type: none"> 1. The machine operates in an unbalanced state due to failure to mount auger or juice filter in place. 2. The starting motor in the frame has been damaged. 	<ol style="list-style-type: none"> 1. Mount auger or juice filter in place or Contact after Sales Support Email: info@iamzchef .com

WARRANTY

Thank you for choosing AMZCHEF product. We sincerely hope that you are satisfied with it.

The manufacturer's warranty covers the product for a period of 12 months from the date of purchase against manufacturing faults. All warranties are automatically kept track of in our system, so there is no need to register your product.

Agent/Distributor is welcome to contact us. Email: info@iamzchef.com.

Any help or questions during use, please contact us via website www.iamzchef.com, send email to info@iamzchef.com, or scan our related QR Codes herein for quick service, we will service you within 24 hours. We suggest to provide a warranty card, a photo or a video if there's broken spare part or not working machine so that we can be much more clear about your problems and offer you the best solution.



WeChat



Facebook



VK



Line



WhatsApp



amzchef Warranty Card

Email: _____

Buyer's name: _____

Address: _____

Tel.: _____

Order Number: _____

Purchase date: _____

Item name: _____

Model: _____

Serial No .: _____

Please fill in the table and email it within 10 days from the date of purchase.

[The body of the page is mostly blank, suggesting the text is either extremely faint or has been redacted. Only a few faint, illegible marks are visible.]