

SHARK 2.0 Owner's Manual



<https://roll-road.com>

Take down your serial numbers here!

Bike frame number:

Battery serial number:

Motor serial number:

**If you reset a security passcode via Display Setting,
we suggest you write it down here in case you may forget:**

Notice: The Default password is:1212, Please visit how to: <https://www.youtube.com/watch?v=dXdg1YDO6Xg>

Contents

◆ About Manual.....	2
◆ Basic specifications.....	3
◆ Battery Pack Installation.....	4
◆ Color LCD Display Manual.....	5
◆ Safety Checklist.....	30
◆ Shark Use&Care.....	32
◆ Trouble Shooting.....	36
◆ Quality Assurance and After-Sale Service	37
◆ Maintenance.....	39
◆ Riding Limitations.....	40
◆ Online Resources.....	40

◆ About Manual

This manual contains details of the product, information on its operation and maintenance, and other helpful tips for owners. Read it carefully and familiarize yourself with the Roll Road e-bike before using it to ensure safe use, reduce risk of damage and premature wear, and prevent accidents. Be sure to retain this manual as your convenient Roll Road e-Bike information source.

This manual contains many Warnings and Cautions concerning safe operation, and consequences if proper setup, operation and maintenance guidelines are not followed. All information in this manual should be carefully reviewed.



The safety grade color of Caution is orange, and if not avoided, may result in moderate or serious injury.



Users should also pay special attention to information marked in this manual beginning with “**NOTICE**”



The safety grade color of Warning is red, and if not avoided will likely result in serious injury or death.

Because it is impossible to anticipate every situation or condition which can occur while riding, this manual makes no representations about the safe use of our bicycles under all conditions. There are risks associated with the use of any bicycle which cannot be predicted or avoided, and which are the sole responsibility of the rider. You should keep this manual, along with any other documents that were included with your bicycle, for future reference, however all content in this manual is subject to change or withdrawal without notice. Visit <http://roll-road.com/> to download the latest version. Assembly and first adjustment of your Roll Road e-Bike requires special tools and skills, and it is recommended that this be performed by a trained bicycle mechanic if possible.

Basic Specifications

Frame	Thickened 6061 Aluminum Alloy	Pedal Assist	Torque Sensors/0-5 level pedal assist
Drive Mode	Half Twist Throttle +Pedal Assist Mode ((individually 5 Levels)	Pedals	Wellgo
Display	Color LCD Display with USB port	Weight	85 lbs(with battery)
Color	Black Frame	Length*Width*Height	70*29*43.3 In
Battery	48V 20Ah Lithium Battery with USB port	Fender	Full fenders
Fork	Hydraulic suspension /Soft and Hard Adjustable Lockout	Lights	1200 lumen LED headlight, water-flowing front and rear turn signals
Shift System	Shimano 7-Speed Gear Shift System	Suspension	Full Suspension
Tire	Kenda 20"*4" In	USB Charging Port	Yes
Chain	KMC	Cruise Control	Yes
Brake	180mm Hydraulic Disc Brakes	Total Payload Capacity	450 lbs
RIM	Aluminum Alloy Spoke Rim	Charging Time	6-8 Hours

◆ Battery Pack Installation Guide



1. After putting the battery into the slot correctly, push it downward into the lock, then push the battery into the frame and lock it;.
2. Notice: the key must be pulled out. (Otherwise the key may be crushed when turning the fork).

NOTICE: Before assembling your bike, it's recommended to remove the battery for the reasons outlined below:

1. Determine if there's battery drain or damage during shipping.
2. Reduce the weight of the e-bike to make it easier to maneuver the bike while assembling.
3. Avoid battery damage during the assembly process.

Shark LCD Display User's Manual

TABLE OF CONTENTS

- ◆ 1. PRODUCT NAME AND MODEL NUMBER.....
- ◆ 2. SPECIFICATION.....
- ◆ 3. APPEARANCE AND SIZE.....
- ◆ 4. FUNCTION OVERVIEW AND FUNCTIONAL AREAS.....
 - 4.1 FUNCTIONAL OVERVIEW.....
 - 4.2 FUNCTIONAL AREAS.....
 - 4.3 BUTTON DEFINITIONS.....
- ◆ 5. ROUTINE OPERATION.....
 - 5.1 POWER ON/OFF.....
 - 5.2 DISPLAY INTERFACE SWITCHING.....
 - 5.3 WALK BOOST MODE.....
 - 5.4 TURNING ON/OFF LIGHTS.....
 - 5.5 PAS LEVEL SELECTION.....
 - 5.6 BATTERY LEVEL DISPLAY.....
 - 5.7 ERROR CODE DISPLAY.....
- ◆ 6. PERSONALIZED PARAMETER SETTINGS.....
 - 6.1 BACKLIGHT BRIGHTNESS.....
 - 6.2 METRIC AND IMPERIAL SETTING.....
 - 6.3 RATED VOLTAGE SETTING.....
 - 6.4 AUTO SLEEP TIME SETTING.....
 - 6.5 PAS LEVEL SETTING.....
 - 6.6 WHEEL DIAMETER SETTING.....
 - 6.7 NUMBER OF SPEED SENSOR MAGNETS SETTING.....
 - 6.8 SPEED LIMIT SETTING.....
 - 6.9 START-UP SETTING.....
 - 6.10 DRIVE MODE SETTING.....

- 6.11 PEDAL ASSIST SENSITIVITY SETTING.....
- 6.12 PEDAL ASSIST STRENGTH SETTING.....
- 6.13 NUMBER OF PEDAL ASSIST SENSOR MAGNETS SETTING.....
- 6.14 CONTROLLER CURRENT LIMIT SETTING.....
- 6.15 BATTERY UNDER VOLTAGE VALUE SETTING.....
- 6.16 TRIP ODOMETER RESET OPERATION.....
- 6.17 CRUISE CONTROL SETTING.....
- 6.18 SPEED RETIO SETTING.....
- ◆ 7. SHORTCUT OPERATION.....
- 7.1 SHORTCUT OPERATION.....
- 7.2 TRIP ODOMETER RESET OPERATION.....
- ◆ 8. WIRE CONNECTION DIAGRAM.....
- 8.1 STANDARD WIRE CONNECTION SEQUENCE.....
- ◆ 9. PRECAUTIONS.....
- SCHEDULE 1: ERROR CODE DEFINITION.....

◆ **1.Product Name and Model Number**

◆ **2. Specification**

- 36V/48V/52V power supply
- Display rated current 15mA
- Display maximum current 30mA
- Shutdown leakage current <1uA
- Supplied current to the controller 50mA
- Operating temperature -20~60°C
- Storage temperature -30 to 70° C

◆ **3. Appearance and Size**



Figure 3-1 Physical picture of the display



Figure 3-2 Physical picture of the K5 control button



Figure 3-3 Physical picture of the K6 control button

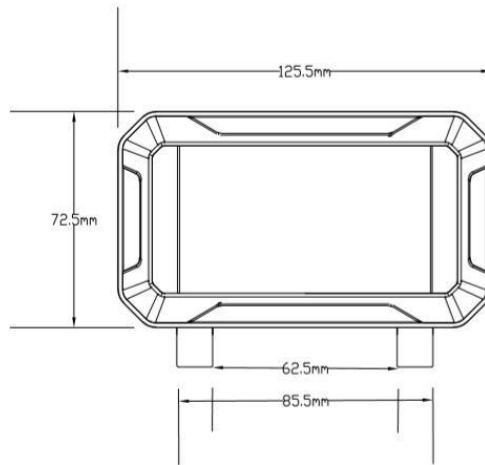

Figure 3-4 90T-H Front View Dimension

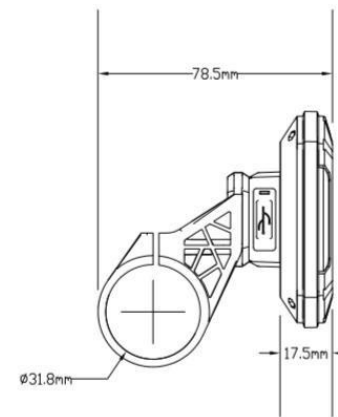

Figure 3-5 90T-H Side View Dimension

◆ 4. Function overview and Functional areas

4.1 Functional overview

The display offers a variety of features to suit your riding needs, including:

- Battery level indicator
- Pedal assist (PAS) level indicator
- Speed (current speed, maximum speed, average speed)
- Mileage display (single and total mileage)
- Walk boost mode
- Light ON/OFF
- Error code indicator
- Motor power indicator (optional)
- USB connection indicator (optional)
- Cruise control indicator (optional)
- Bluetooth connection indicator (optional)
- Personalized parameter settings (e.g. wheel diameter, speed limit, battery power setting and PAS parameter setting, password setting, controller current limit setting, etc.).
- Factory default parameter recovery function

4.2 Functional areas

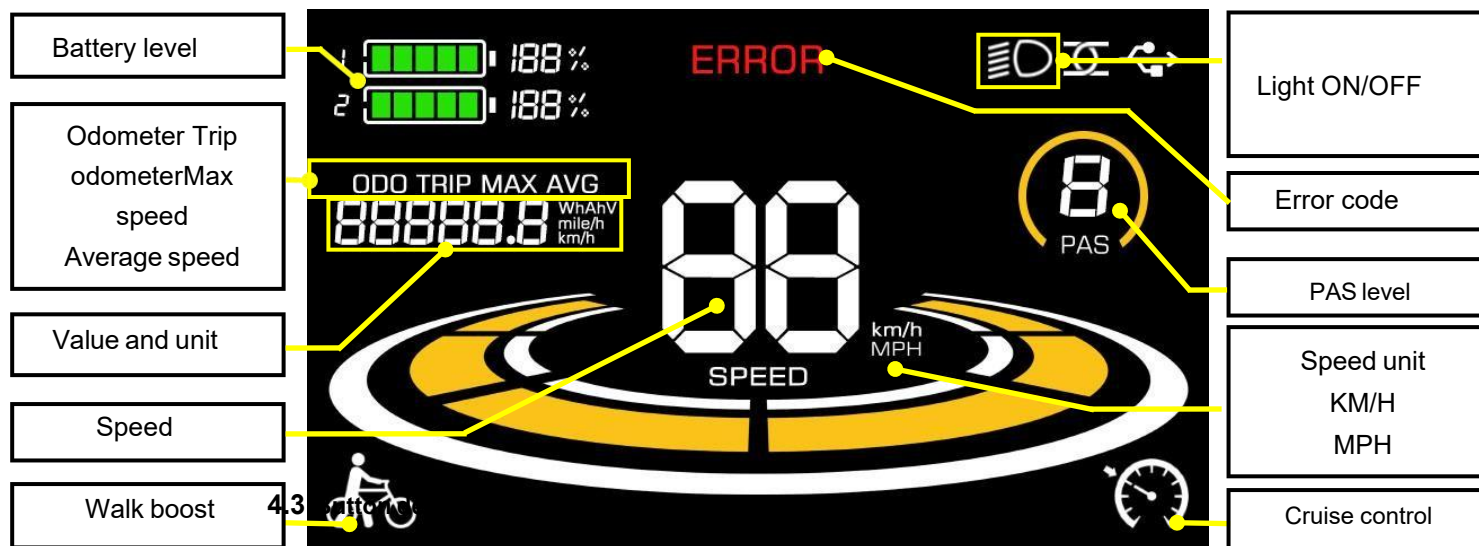







Figure 4-2 functional area distribution interface

The display is equipped with five buttons on the corresponding operating unit: power on/off , plus , minus , light  and toggle .

◆ 5. Routine operation

5.1 Power on/off

Long press  to power on/off the display. When the display is off, it will not use the battery power and the leakage current is less than 1uA.

⚠ The display will automatically shut off if it is not used for more than 10 minutes.

5.2 Display interface switching

When the display is powered on, it will show the Current Speed (km/h) and Odometer (km) by default. Short press  to switch between Odometer (km), Trip Odometer(km), Maximum Speed (km/h), and Average Speed (km/h).



Odometer



Trip Odometer

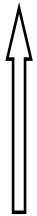

Average speed



Maximum



Figure 5-2 Display Interface Switching

5.3 Walk boost mode



Long Press and hold , the electric bicycle enters the walk boost mode. The electric bicycle will walk at a fixed speed of 6 km per hour and the display shows . Release the button to stop the power output immediately and restore to the state before walk boost. (⚠️ Some protocols do not support this function)



Figure 5-3 Helping to implement the display screen

⚠️ The walk boost mode can only be used when pushing the electric bicycle, please do not use it while riding.

5.4 Turning on/off lights



Press the  to make the controller turn on the lights and the display backlight becomes dim. Press  again to make the controller turn off the lights and the backlight restore brightness.

Figure 5-4 Backlight display interface



5.5 PAS level selection

Press **+** / **-** to switch PAS level of electric bicycle, thus changing the motor output power.



Figure 5-5 PAS level display interface

5.6 Battery level display

The Battery level is shown as 5 bars. When the battery is full charged, all of the 5 bars lighten up. When the battery is fully depleted, the bar will begin to flash, warning the user to charge the battery as soon as possible.

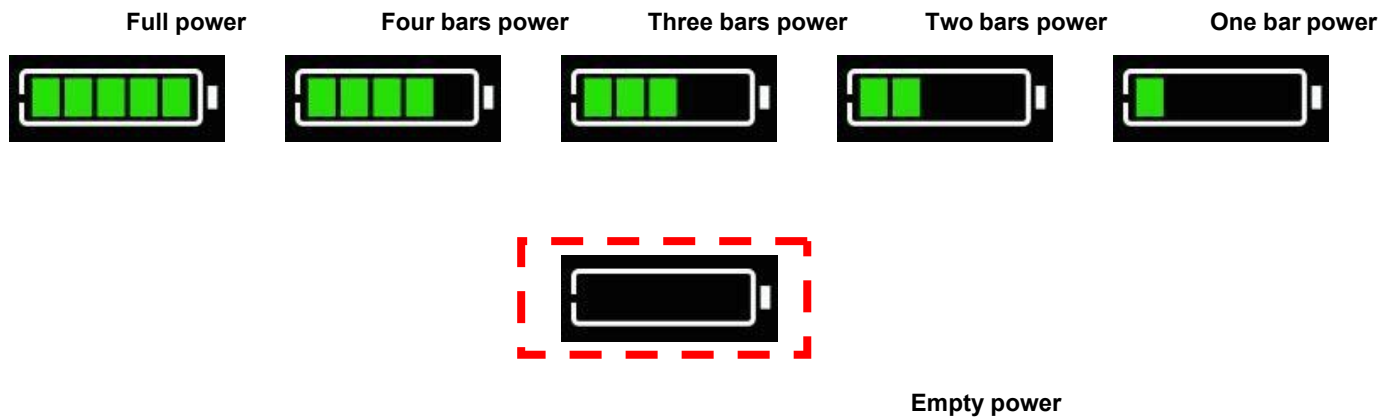

Figure 5-6 Battery Level Display Interface

5.7 Error code display

If there is a fault occurs in the electronic system of the electric bicycle, the display will automatically show an errorcode, see **Schedule 1** for a detailed definition of the error code.



Figure 5-7 Error Code Display









⚠When the error code appears on the display, please troubleshoot the problem in time, the electric bicycle will not be able to drive normally after the problem

occurs.

◆ 6. Personalized parameter settings

⚠ Each setting needs to be done with the bicycle stationary.

The personalized parameter setting procedure is as follows: When the display is ON and the speed shows 0,

- (1) Press   at the same time and hold simultaneously for more than 2 seconds to enter the personalized parameter setting interface.
- (2) Press  /  to toggle between the personalized parameter setting interface, and press  to enter the parameter changing state.
- (3) Press  /  to select the parameter, long press  for addition operation, long press  for subtraction

operation.

- (4) Press  to save the parameter settings and return to the personalized parameter setting interface.

(5) Long Press  to save the parameter settings and exit the personalized parameter setting interface. The following options are available on the personalized parameter setting interface:

6.1 Backlight Brightness Setting

01P is the backlight brightness setting, 00 for darkest, 01 for standard and 03 for brightest.





Short press  to enter the parameter changing state. Press the  /  to select the parameter and press  to save the parameter setting and return to the personalized parameter setting interface.



Figure 6-1 Backlight Brightness Setting Interface

6.2 Metric and Imperial setting

02P is the metric and imperial setting, 00 for metric and 01 for imperial.

Press **i** to enter the parameter changing state. Press the **+**/**-** to select the parameter and press **i** to save the parameter setting and return to the personalized parameter setting interface.



Figure 6-2 Metric and Imperial Units Setting Interface

6.3 Rated voltage setting

03P is the rated voltage setting. The available rated voltage range is: 24V, 36V, 48V.

Press **i** to enter the parameter changing state. Press the **+**/**-** to select the parameter and press **i** to save the parameter setting and return to the personalized parameter setting interface.



Figure 6-3 Rated voltage setting interface

6.4 Auto Sleep Time Setting

04P is the auto sleep time setting. To save the battery power and reach higher range, this display will be turned off after it has not been used for a time. The adjustable range is: 1~60min, 00 means no auto shutdown. The factory default setting is 10 minutes.

Press **i** to enter the parameter changing state. Press the **+**/**-** to select the parameter and press **i** to save the parameter setting and return to the personalized parameter setting interface.

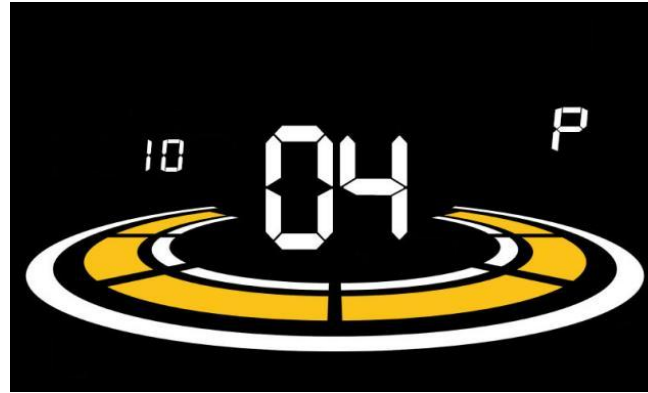

Figure 6-4 Auto Power Off Time Setting Interface

6.5 PAS level setting

05P is the Pedal assist (PAS) level setting. The available Pedal assist level settings are: 0~3, 1~3, 0~5, 1~5, 1~7, 0~7, 0~9, 1~9.

Press **i** to enter the parameter changing state. Press the **+**/**-** to select the parameter and press **i** to save the parameter setting and return to the personalized parameter setting interface.



Figure 6-5 PAS level setting interface

6.6 Wheel diameter setting

06P is the wheel diameter setting. The adjustable wheel diameter range is: 1~50inch.

Press **i** to enter the parameter changing state. Press the **+**/**-** to select the parameter and press **i** to save the parameter setting and return to the personalized parameter setting interface.



Figure 6-6 Wheel diameter setting interface

6.7 Number of speed sensor magnets setting

07P is the speed sensor magnet number setting. The adjustable speed sensor magnet number range is: 1 ~ 255 pcs..

Press **i** to enter the parameter changing state. Press the **+** / **-** to select the parameter and press **i** to save the parameter setting and return to the personalized parameter setting interface.



Figure 6-7 Number of speed sensor magnets setting interface

6.8 Speed Limit Setting

08P is the speed limit setting. The adjustable speed limit range is: 1~100km/h. (The maximum adjustable speed limit varies by different protocols)

Press **i** to enter the parameter changing state. Press the **+**/**-** to select the parameter and press **i** to save the parameter setting and return to the personalized parameter setting interface.



Figure 6-8 Speed limit setting interface

6.9 Start-up setting

09P is the start-up setting. The display can choose the following start modes: 00→zero start, 01→non-zero start.

Press **i** to enter the parameter changing state. Press the **+**/**-** to select the parameter and press **i** to save the parameter setting and return to the personalized parameter setting interface.



Figure 6-9 Start-up setting interface

6.10 Drive mode setting

10P is the drive mode setting. The available drive modes are: 00→Pedal assist only, 01→Electric only, 02→Both Pedalassist and electric.

Press **i** to enter the parameter changing state. Press the **+** / **-** to select the parameter and press **i** to save the parameter setting and return to the personalized parameter setting interface.

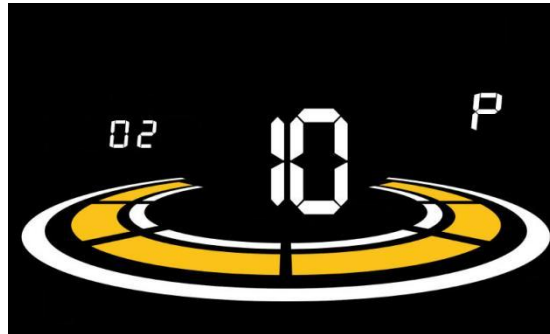

Figure 6-10 Drive mode setting interface

6.11 Pedal assist sensitivity setting

11P is the pedal assist sensitivity setting. When set to higher numbers, it will take more crank rotations to activate the motor. On lower numbers, it will take little crank rotation to activate the motor. The adjustable range is: 1~24.

Press **i** to enter the parameter changing state. Press the **+** / **-** to select the parameter and press **i** to save the parameter setting and return to the personalized parameter setting interface.

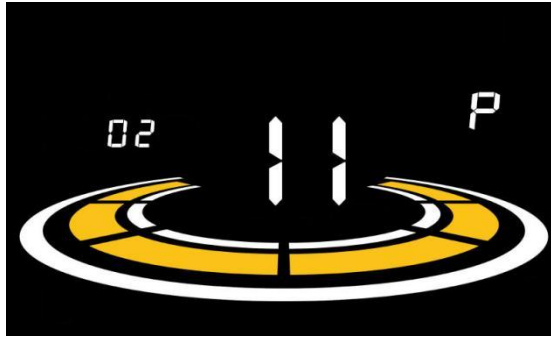

Figure 6-11 Pedal assist sensitivity setting interface

6.12 Pedal assist strength setting

12P is the Pedal assist strength setting. The Pedal assist strength is the relative strength of the PWM signal from the controller when start to activate pedal assist. The adjustable range is 0 ~ 5. 0 is the weakest strength and 5 is the strongest.

Press **i** to enter the parameter changing state. Press the **+**/**-** to select the parameter and press **i** to save the parameter setting and return to the personalized parameter setting interface.



Figure 6-12 Pedal assist Start-up intensity setting interface

6.13 Number of pedal assist sensor magnets setting

13P is the number of pedal assist sensor magnets setting. The adjustable range: 5~12 pcs.

Press **i** to enter the parameter changing state. Press the **+**/**-** to select the parameter and press **i** to save the parameter setting and return to the personalized parameter setting interface.

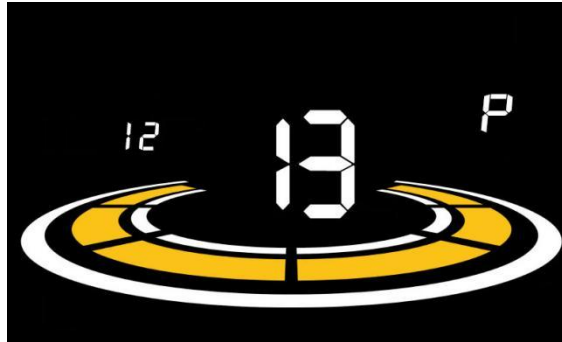

Figure 6-13 Number of pedal assist sensor magnets setting interface

6.14 Controller Current Limit Setting

14P is the controller current limit setting. The adjustable range is: 1~50A.

Press **i** to enter the parameter changing state. Press the **+** / **-** to select the parameter and press **i** to save the parameter setting and return to the personalized parameter setting interface.



Figure 6-14 Controller current limit setting interface

6.15 Battery under voltage value setting

15P is the battery under voltage setting. The value can be adjusted based on the current rated voltage.

Press **i** to enter the parameter changing state. Press the **+**/**-** to select the parameter and press **i** to save the parameter setting and return to the personalized parameter setting interface.

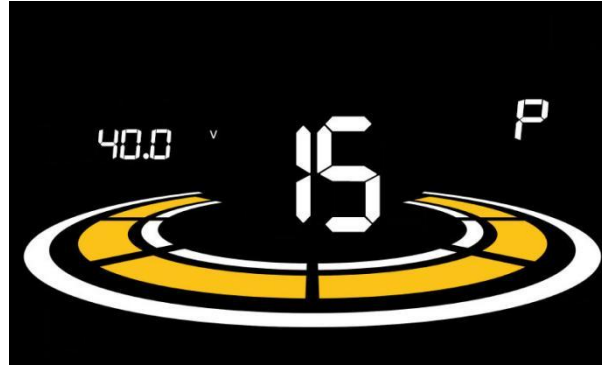

Figure 6-15 Battery under voltage value setting interface

6.16 Trip Odometer Reset Operation

16P is the total mileage reset setting, and the adjustable range is: 00--not reset; 01--reset the odometer.

Press **i** to enter the parameter changing state. Press the **+**/**-** to select the parameter and press **i** to save the parameter setting and return to the personalized parameter setting interface.

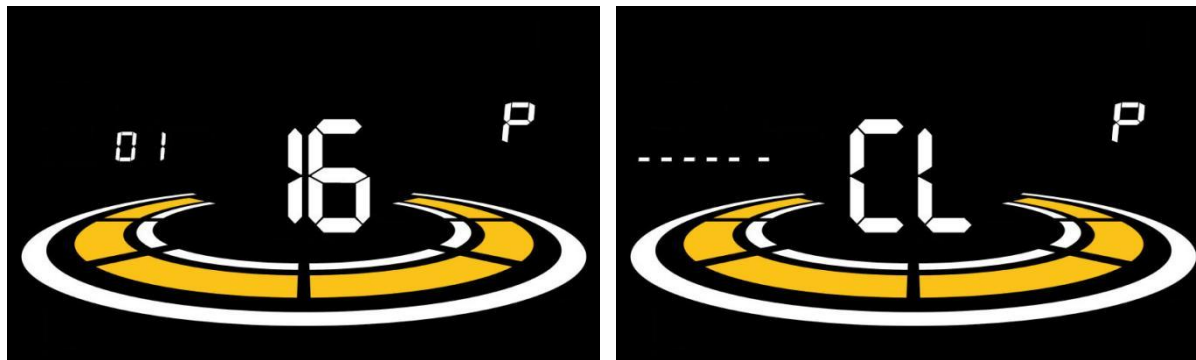

Figure 6-16 Trip odometer reset setting interface

6.17 Controller Cruise Control Setting

17P is the controller cruise control function setting, The adjustable range is: 00-non automatically cruise control; 01-automatically cruise control..

Press **i** to enter the parameter changing state. Press the **+**/**-** to select the parameter and press **i** to save the parameter setting and return to the personalized parameter setting interface.

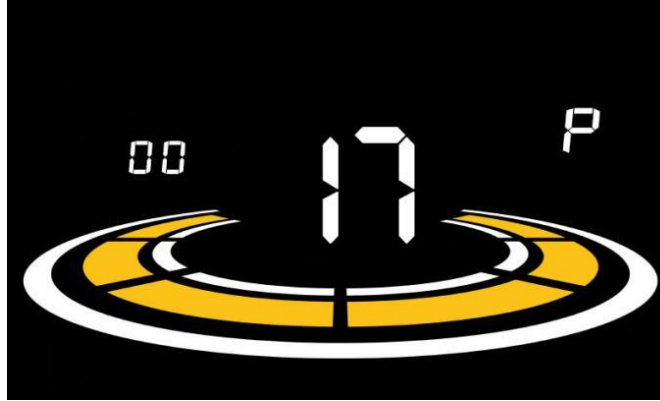

Figure 6-17 Controller cruise control function setting interface

6.18 Speed ratio Setting

18P is the speed ratio setting option, the speed ratio setting range is: 50 ~ 150

Press **i** to enter the parameter changing state. Press the **+**/**-** to select the parameter and press **i** to save the parameter setting and return to the personalized parameter setting interface.

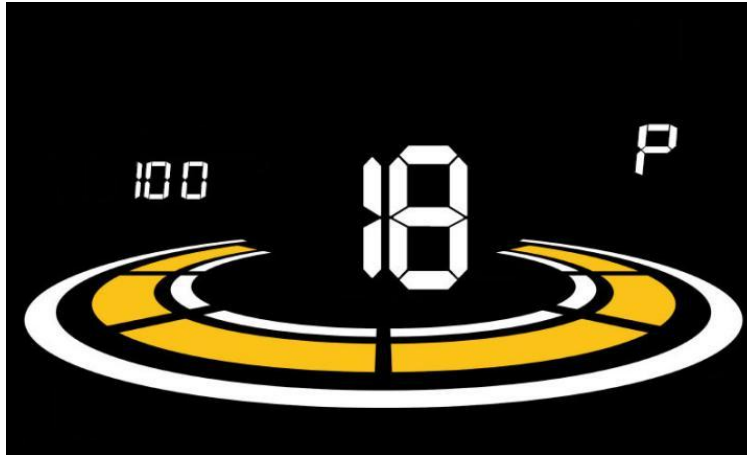



Figure 6-18 Controller cruise control function setting interface

7.Shortcut operation

- 7.1 Restore factory settings operation

dEF is the restore factory default parameter settings. dEF-Y is to restore the factory default settings, and dEF-N is notto restore.

Enter into the main setting interface and keep the speed at 0, press and hold  and  simultaneously for 2s to



enter the restore factory default setting interface. Pressing  /  to toggle to dEF-Y. Then after pressing  to confirm, the display will show dEF-0 for a few seconds and then automatically start to restore the factory default settings.The display will automatically exit to setting interface after the restoration.



Figure 7-1 Restore Factory Default Settings Interface

-
- **7.2 Trip odometer reset operation**

The display can record trip odometer and odometer. Trip odometer is not automatically reset after turning off. The trip odometer needs to be reset manually. The odometer can not be reset.

Enter into the main setting interface and keep the speed at 0, press and hold  and  simultaneously for 2s to reset the trip odometer. The main interface will flash during the reset process.

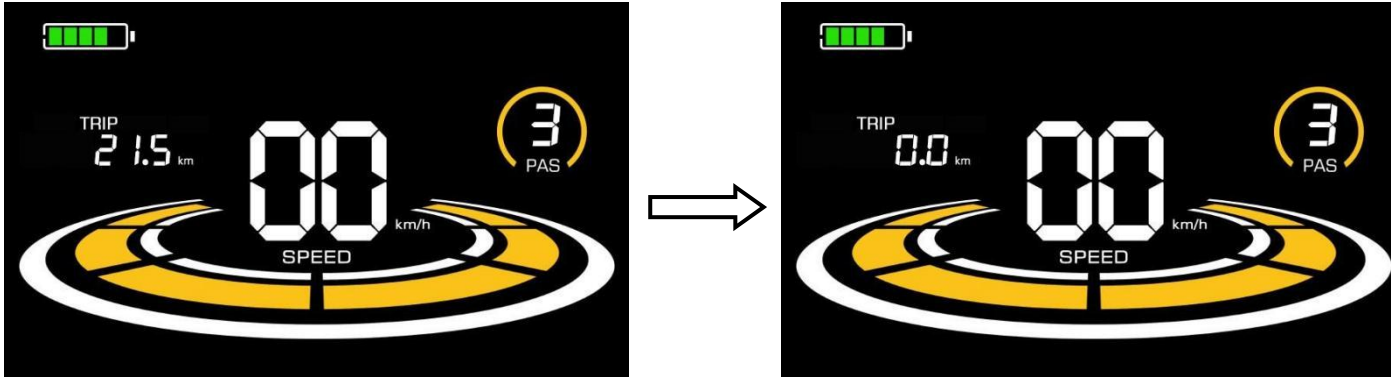
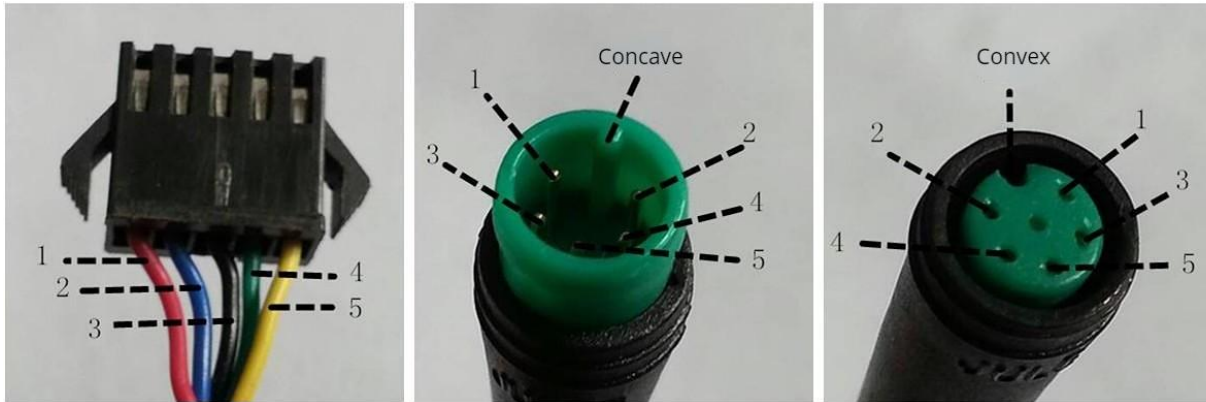

Figure 7-2 Trip Odometer Reset Interface

◆ 8. Wire connection diagram

8. Standard wire connection sequence



Controller connector Display connector (Female terminal) Display connector (Male terminal) Figure 8-1 Wire Connection Diagram

Table 8-1 Standard connector wire sequence table

Standard Wire Sequence	Standard wire color	Function
1	Red (VCC)	Display power wire
2	Blue (Kp)	Controller power wire
3	Black (GND)	Display ground wire
4	Green (RX)	Display data reception wire
5	Yellow (TX)	Display data transmit wire

1.

Some models are equipped with waterproof connectors and the color inside wires can not be seen.

◆ 9. Precautions

Pay attention to all the general operating when using the products and do not plug and unplug the display while it is powered on.

- ◆ Avoid bumping the display as much as possible.
- ◆ Please do not change the parameter settings at will, otherwise normal riding cannot be guaranteed.
- ◆ If display does not work properly, please send it to the repair center as soon as possible.
- ◆ There may be differences between the physical products and this manual due to normal upgrade. Please refer to the physical products.

Schedule 1: Error Code Definition

YL-01, YL-02 Error codes				
Error Code	Definition		Error Code	Definition
E001	Controller failure		E004	Throttle failure
E002	Communication failure		E005	Brake failure
E003	Hall failure		E006	Motor phase failure
YL-05, KDS, YL-J Error codes				
Error code	Definition		Error code	Definition
E021	Current failure		E024	Hall failure
E022	Throttle failure		E025	Brake failure
E023	Motor phase failure		E030	Communication failure

◆ Safety Checklist

<ul style="list-style-type: none"> • Safety Check 	<ul style="list-style-type: none"> • Basic Steps
<ul style="list-style-type: none"> • Brakes 	<ul style="list-style-type: none"> • Test front and rear brakes for proper function. • Ensure brake pads are not over-worn and are correctly positioned in relation to rims. • Check that brake control levers are lubricated and tightly secured to handlebars.
<ul style="list-style-type: none"> • Wheels and Tires 	<ul style="list-style-type: none"> • Inflate tires to within recommended limits displayed on sidewalls. • Check for bulges or signs of excessive wear. • Clean tires to ensure tread is exposed. • Ensure rims run true and have no obvious wobbles or kinks. • Check that all wheel spokes are tight and not broken. • Check the wheel balance in Pedal Only Mode. If you notice the riding is imbalanced or the rotation of the front wheel makes noise, it means the bolts were not completely tightened or not aligned horizontally.
<ul style="list-style-type: none"> • Chain 	<ul style="list-style-type: none"> • Check that chain is oiled, clean and runs smoothly. • Use extra care in wet or dusty conditions.
<ul style="list-style-type: none"> • Cranks and Pedals 	<ul style="list-style-type: none"> • Securely tighten pedals to cranks. • Ensure cranks are securely tightened and are not bent.
<ul style="list-style-type: none"> • Derailleurs 	<ul style="list-style-type: none"> • Check that derailleur(s) are adjusted and functioning properly. • Ensure shift and brake levers are attached to handlebar securely. • Check all brake and shift cables for proper lubrication.
<ul style="list-style-type: none"> • Motor Ride 	<ul style="list-style-type: none"> • Ensure hub motor is spinning smoothly and motor bearings are in good working order. • Check that all power cables running to hub motor are secured and undamaged. • Make sure hub motor axle bolts are secured and all torque arms and torque washers are in place.
<ul style="list-style-type: none"> • Battery Pack 	<ul style="list-style-type: none"> • Ensure battery is charged before use. • Check for any visible damage to battery pack. • Lock battery securely to frame. • Charging: Plug in the charger first, then plug the power supply.

◆ Safety Precautions

The following safety notes provide additional information on the safe operation of your Shark bike and should be closely reviewed. Improper operation, or failure to confirm correct installation, compatibility, and maintenance of any component or accessory may result in serious injury or death.

◆ Before Riding

- All users must read and understand this manual before the first use. Additional manuals for components used on your bicycle may be provided and should also be read before use.
- Ensure you understand all instructions and safety notes/warnings.
- Follow the safety checklist before the first use and at regular intervals to ensure correct tightening and setup of your bicycle.
- Ensure the bike fits you properly before the first use. Check local rules and regulations before riding.
- It is your responsibility to familiarize yourself with the laws and requirements of operation of this product in the area(s) where you ride.

◆ While Riding

- Always wear an approved bicycle helmet whenever using this product and ensure that all helmet manufacturer instructions are used for fit and care of your helmet. Failure to wear a helmet when riding may result in serious injury or death.
- Acceleration can be unexpectedly strong in pedal assist mode (Pedal Assist level 1-5), as when you pedal the motor assist will suddenly engage. Therefore, please pay careful attention when riding. We suggest you use Pedal Only Mode (Pedal Assist level 0) when you need to ride at a slow speed to cross roads, at intersections, or when pedestrian traffic is present, in order to avoid accidents caused by sudden acceleration.
- Make sure you securely close the quick-release lever of the front wheel, checking the wheel balance in Pedal Only Mode. If you notice that the bike riding feels imbalanced or the rotation of the front wheel makes noises, it likely means the bolts were not completely tightened or didn't align horizontally in the center.
- Off-road riding requires close attention and specific skills, and presents variable conditions and hazards which accompany the conditions.
- Wear appropriate safety gear and do not ride alone in remote areas.



A. Electric bike riders must be at least 16 years old. Please abide by the local road traffic safety rules, wear a helmet when riding, and check the e-bike safety according to the safety checklist before riding.

B. Keep the key with extra care because there is only one pair, even the manufacturer doesn't own a back-up.

◆ Shark Use and Care

◆ Considerations for safe riding

- 1. Please observe traffic regulations and ride it safely. Please control the speed within safe speed range (note: safe speed of this bicycle is within 45km/h).
- 2. Before riding, get familiar with this Instructions first, and then perform exercise at an open site. Make sure that you fully master riding skills and get familiar with the structure and performance of this bicycle, which are the foundation for safe riding.
- 3. Do not lend it to those people who are not familiar with or unable to ride it or ask them to ride it. It is dangerous to ride it by one hand or even without hands or ride it when intoxicated.
- 4. Take more care when riding it in raining or snowy days: danger may occur due to wet ground in raining or snowy days! Thus, you should ride it at a low speed and pay more attention when turning. You must particularly remember that you do have to brake in advance in raining or snowy days to prevent accidents!!
- 5. Wear a helmet correctly: wear a helmet correctly and tighten the belt when riding. And wear suitable clothing: do not wear tights so that your whole body can move freely. You should wear clothing with sleeves unopened and low-heel shoes as practicable as possible.
- 6 Note: in order for ease maintenance, repair and service, each bicycle produced by our company is marked with a bicycle frame number and motor number, so as to assist distribution unit to provide better service for you. The bicycle number is engraved on the seat plate, and the motor number is engraved on the outer housing cover of the motor.
- 7. Do not overload: the max load of this bicycle is 350LBS. As the feeling of handlebar with load is different from that without load, when many articles are loaded, holding handlebar will vibrate which may result in danger.

◆ Methods for correct operation

• Riding method

- 1.Keep the natural posture and free riding can be gotten.
- 2. Riding in sitting posture: please always keep your body in the middle of the bike to prevent load reduction of the front tire and danger caused by handle bar vibration.
- 3. Riding in standing posture: when speeding up, you should turn the handle slowly, therefore danger caused by instability due to sudden speeding-up should be avoided.
- 4. Ride it slowly on roads with surface damaged or that paved with gravels. In rainy or snowy days, wet ground will easily cause side slip, so you should ride it slowly with much attention.
- **Parking method** : When parking, please pay attention to those vehicles and pedestrians around. Park it to the right side of flat road slowly, do not park it on a slope. After parking it stably, turn the power supply lock rightwards to pull it out and take it down and then lock the bicycle with a lock.
- **Operation method**: For electricity indication, after the power supply lock is connected, the voltage indicator light will be turned on. At full charge of capacity, there are green, yellow and red light, with 5 grids in total. The green light has three grids, with each grid of 25% of rated electricity; each grid of the yellow light is 20% of rated electricity; while each grid of the red light is 5% of rated electricity. The yellow light going out while the red light going on indicates that there is no electricity left, so when you find that the blue light goes out. you should charge the bicycle immediately.
- **Half-twist throttle (speed-governing handle)** : Twist the throttle on the right hand, the bicycle will be sped up; and if it is released to turn back, the speed will be reduced.
- **Operation method of disc brake and considerations**

(1) Operation method of disc brake

Brake clearance adjustment: turn the adjusting screw which is located between the braking handle and the handlebar tube using a 2mm Allen wrench, adjust the clearance between braking pads and the braking disc until your hand feeling is comfortable.

Replace the braking pad when braking pads are worn off by more than 1 mm or the adjusting screw of braking pads are adjusted to the end position or every half a year. when replacing braking pads, press in one of braking pads using a clean slotted screwdriver to vacate space for taking out the other braking pad. After replacement is complete, it is needed to return the adjusting screw of braking pads to a suitable position (a position that makes your hand feeling comfortable).

Run-in period: the run-in of disc brake surface needs a certain time. After complete run-in, braking force will increase significantly. The first week in which you use a new disc brake is the run-in period. During run-in period, do not brake with too great force, otherwise unrecoverable damage will be caused to braking pads and braking body. The correct operation method is to brake slightly during riding, so that there is appropriate friction kept between braking pads and the disc brake.

(2) Considerations

Do not use lubricating oil around the disc brake and braking pads, as well as the calliper. Do not touch the surface of disc brake and braking pads with hands, otherwise braking performance will be reduced significantly. You'd better not shower a new brake to prevent a small quantity of lubrication grease in assembling clearance from contaminating braking pads. Oil hydraulic disc brake has strong braking force, you need to do much exercise at a safe place, so as to adapt to the difference from a common brake to avoid braking with too great force, resulting in injury due to wheel lockup.

◆ Operation method of the charger and considerations

(1) Operation method

- ① when charging, plug in the plug of cell box first, then that of electric supply AC100V-230V. when charging is complete, take the counter procedures, that is, unplug the plug of electric supply AC100V-230V, then that of cell box.
- ② During normal charging, the indicator light of the charger shows red. when fully charged, it will turn green;
- ③ If charging ambient temperature is too high, the red light will flash, which indicates that the charger is in the temperature protection state. Please take the charger to a cool or well-ventilated place. when the inside temperature of the charge lowers to 60℃, normal charging occurs.

(2) Considerations

- 1 The charger can only be used indoors.
- 2 Charging in a closed space or under scorching sun or at a high temperature environment are strictly prohibited. Do not put the charger on a seat cask or inside the rear compartment for charging.
- 3 In case of no charging, do not connect the charger to an AC power supply without load for a long time. During charging, if the indicator light is abnormal and abnormal smell occurs or the housing of the charger turns too hot, please stop charging immediately, then repair or replace the charger.
- 4 Do not disassemble or replace the devices inside the charger by yourself.
- 5 Do not charge the charger that has been fully charged.
- 6 Do not use the charger in an environment with flammable gas, otherwise explosion or fire will be caused.

7 Do not submerge the battery pack in liquid or use it in wet areas, otherwise fire or electric shock may occur.

8 In the event that inside parts are exposed due to charger damage caused by collision, etc., do not touch them with hands, otherwise you may be injured due to electric shock.

(3) Charging

1 Only use the charger supplied with the bicycle. Irregular or non-conforming chargers may reduce life the cell or invalid the cell!

2 The cell that has been fully discharged (the bicycle stop running) can be charged with more than 95% of electricity within 5h, and can be fully charged within 8h.

3 During charging, neither the positive end nor the negative end is allowed to be contacted metal.

4 when leaving factory, the cells electricity is about 80%. Prior to riding a new bicycle, charge it for 3~10h.

5 If the bike is left for more than one month, electricity will reduce by about 5%. It is recommended to charge it before use. Please charge the cell timely to ensure riding mileage.

6 During charging, the charger may became hot. As long as the temperature does not exceed 140° F (60° C) , it is normal. when charging, please put the charger and the whole bicycle at a stable and dry place which is free of flammable and explosive goods and is out of reach of children.

7 You should charge the cell within 24h after it is fully discharged, and charging time should not be less than 3h.

8 Do not short-circuit the battery pack's terminals.

(4) Discharging (use)

1 Do not use the cell for purposes other than the electrical bicycle of this model, otherwise warranty will not be provided.

2 Once short-circuit occurs, the cell management system will provide automatic protection, and the fuse piece connected in series with power line will fuse, giving dual protection for your cell. About 2 minutes after the short circuit is released and the fuse piece is replaced, the cell will work normally.

3 Damage or unreasonably configuration of the controller, motor, lighting facility, etc. of electrical bicycle will all cause the cell to discharge at high current. At this time, the cell will stop output for protection, but will recover within 10s, which will not affect your riding.

4 Working temperature range of the cell: -10°C —55°C . Like other cells, its available energy will reduce with the rise of temperature, which is a normal phenomenon.

(5) storage

1 If long-time storage (more than one month) is needed, it is recommended to charge the cell to 60%—80% of electricity. During storage, it is needed to charge the cell every 3 months, and charging is also needed before usage.

2 The cell should be stored at a cool and dry environment.

3 During storage, prevent conductive objects connecting the positive pole with the negative one.

4 Do not use the cell near fire or heat source. (Do not disassemble the cell.)

(6) warning

1 If the cell is found to deform or become hot, you should stop using and seek help from our company or repair department.

2 In case of fire, do not quench the fire directly using water. It is recommended to quench it using foam extinguisher or thick clothing soaked with water.

3 For the cell fault caused by delayed charging fully-discharged cell, warranty will not be provided.

4 Do not discard the cell haphazardly.

◆ **Check, cleaning and maintenance**

(I) Regular or daily check

1. Check the whole bicycle at a safe place.

2. Check whether the abnormal part found the day before impacted running.

3. Braking effect of the brake: check whether the braking handle can be holding and pinching gently and whether the clearance is appropriate. Check whether it can brake bicycle normally.

4. Check whether there are chaps, damage or abnormal wear on tires or whether there are such sharp objects as metal, pebble, glass embedded in tires. If the lug on a tire has been worn off by 2/3, replace the tire.

Check tires, air pressure according to sunken condition of the part of tires contacted with ground. The normal air pressure of front and rear tire is 1.5kg/cm².

5. Check whether the power supply voltage indicator indicates full capacity

6. Steering system: swing the handle and front fork upwards, downwards, forwards, backwards, leftwards and rightwards to check whether tightness is suitable and steering is flexible, and whether there are such problems as abnormal sound caused by collision, steering system loosening, collision sound. If there are, please contact the distributor, so as to provide perfect after-sale service for you.

7. Check whether the front and rear wheel shaft become loose.

◆ Basic Troubleshooting

No	Symptoms	Possible Causes	Solutions
1	Speed-governing fault or max. speed reduced	<ul style="list-style-type: none"> ● Too low cell Voltage ● Speed-governing throttle damage ● Spring inside throttle goes stuck or fails 	<ul style="list-style-type: none"> ● Charge the cell ● Go for the distributor for replacement
2	Motor not working	<ul style="list-style-type: none"> ● The cells connecting line becomes loose ● .Speed governing throttle damaged ● Motor output line becomes loose or damaged 	<ul style="list-style-type: none"> ● Reconnect it: ● Ask the distributor for replacement ● Ask a repair store for help
3	Continuous riding mileage is not sufficient after charging.	<ul style="list-style-type: none"> ● Low tire pressure ● Low battery power or charger fails ● .Aging of the cell or damaged ● Driving on rough terrain ● Great headwind, frequent braking and starting, heavy load on bike 	<ul style="list-style-type: none"> ● Inspect tire ● Fully charge the cell or replace the charger ● Replace the cell ● Adjust route ● Adjust bike load,include pedal assist use
4	Charger fails to charge	<ul style="list-style-type: none"> ● Charger nor properly connected ● Fuse inside the cell box fused ● Battery packs connecting wire falls off 	<ul style="list-style-type: none"> ● Inspect connections ● Replace the fuse <ul style="list-style-type: none"> ● Weld connecting wires
5	Other symptoms	<ul style="list-style-type: none"> ● Fault that you cannot determine; the inside of the motor, cell, controller, charger, etc. damaged 	Please ask the distributor for repair, do not open these parts by yourself. Otherwise, warranty will not be provided.

◆ Quality Assurance and After-Sale Service

1. Administration of Quality and Technology supervision

In order to practically protect consumer's legal rights and interests, perfect the civil responsibility system about product quality and perform warranty obligation and responsibility, you can enjoy 2-year warranty service from the maintenance & service station designated by the bicycle-selling unit by virtue of the warranty card, and specific provisions are as follows:

2. Warranty authentication standard of e-bike

Number	Part name	Standard for replacement	Standard for non-replacement	Quality assurance time
1	Handle Tube	Broken	1. Damage caused by human factor or improper use; 2.The user changes the state by himself; 3. seriously defective accessories	2 years
2	Front Fork	Broken	Damage caused by human factor or improper use	2 years
3	Bottom Fork	Broken	1. Damage caused by human factor or improper use; 2. The user changes the state by himself; 3. seriously defective accessories	2 years
4	Bicycle Frame	Broken	1. Damage caused by human factor or improper use; 2. The user changes the state by himself; 3. seriously defective accessories	2 years
5	LCD Display	Broken	1. Damage caused by human factor or improper use; 2. The user changes the state by himself; 3. seriously defective accessories	1 year
6	Controller	Failure	Improper use or man-made damage	1 year
7	Lithium Cell	In case that the capacity fading all the 15th month as from manufacturing date is lower than 40%; in case that the capacity fading at the 16th - 24th month as from manufacturing date is lower than 20%.	Housing damage caused by human factor of improper use, incorrect use of the charger, assembly and disassembly the cell by yourself, using the cell at high temperature (A60x*)- discharging at high current for a long time, short circuit caused by man-made immersion water	1 year
8	Rear Hub Motor	Failure	1. Damage caused by human factor or improper use; 2. The user changes the state by himself; 3. seriously defective accessories	1 year
9	Charger	Failure	Improper use or man-made damage	6 months
10	Headlight	Broken	1. Damage caused by human factor or improper use; 2. The user changes the state by himself; 3. seriously defective accessories	3 months

11	Disc brake	The upper or lower oil pump leaked or damaged; the braking handle broken due to manufacturing defect; oil tube damaged or leaked oil, etc.	1. Damage caused by human factor or improper use; 2. The user changes the state by himself; 3. seriously defective accessories	1 month
12	Tire	Broken	1. Damage caused by human factor or improper use; 2. The user changes the state by himself; 3. seriously defective accessories	1 month

◆ Safety and Care Instructions

To ensure safe riding conditions and maximize e-bike longevity, you must follow the guidelines outlined below:

- To clean the e-bike, wipe the frame with a damp cloth soaked in a mild, non-abrasive, non-corrosive detergent mixture. Wipe or spray all unpainted parts with anti-rust treatment after being used in coastal areas or areas with salty air or water.
- Never immerse the bike or any components in water, as the electrical system may be damaged. If the hub and bottom bracket bearings have been submerged in water, they should be removed and re-greased (this will prevent accelerated bearing deterioration).
- Periodically check wiring and connectors to ensure there is no damage, and the connections are secure.
- Store under shelter, avoiding extended exposure to cold or inclement weather. If exposed to rain or excess moisture, dry your bicycle afterward and apply anti-rust treatment to the chain and any other unpainted steel surfaces.
- Regularly clean and lubricate all moving parts, tighten components and adjust as required.
- Your cables, spokes, and chain will stretch after an initial break in period of 80-160 km, and additionally bolted connections can loosen with time and usage. Therefore, we suggest you contact a certified bicycle mechanic every two months to ensure your bike is safe and problem-free for years of use.
- If the paint has become scratched, or the metal chipped, use touch-up paint to prevent rust (clear nail polish can also be used as a preventative measure).
- Damage from corrosion is not covered under warranty, therefore special care should be given to protect and extend the life of your bike.

◆ Maintenance

◆ Battery Maintenance

1. Don't fully drain your battery. Turn off the power when the battery charge is low.
2. Fully charge the battery after each use, no matter how much power has been used. This will prolong the battery life. If the battery is not used for a long time, store the battery with a full charge and charge it once a month.
3. The Shark Bike can be safely ridden in light rain. However, riding through very heavy downpours or through flooded streets is not recommended, as the crank and/or motor can get wet, which may cause problems.
4. Keep the battery away from open flame or a high-temperature heat source. Do not expose the battery to direct sunlight or recharge immediately after use in high-temperature weather.

◆ Chain Maintenance

1. We recommend cleaning the chain after each ride, especially in rainy and humid environments. Use a dry cloth to wipe the chain and its accessories clean. Use a brush to remove sand and dirt stuck in the chain, along with use warm soapy water if needed. Do not use strong acidic or alkaline cleaning agents (such as rust remover), because these chemicals can damage the chain.
2. Apply lubricating oil after cleaning to avoid rust. First, make sure the chain is dry, and then apply the lubricating oil into the bearings.
3. To prevent unnecessary chain wear, try to maintain a vertical chain position when shifting gears (do not use the smallest gear with the smallest fly wheel, or the largest gear with the largest fly wheel, etc.).

◆ Front Fork Maintenance

1. Always use a clean, oil-free lint-free cloth with plain or soapy water to clean your bike. To prevent water from flowing into the front fork, you can turn the bike upside down. Dry with a lint-free towel after washing. Pay specific attention to the inner tube and the dust seal to reduce wear and prevent thinning of the inner tube, which can lead to significant damage if the aluminum is exposed to air.
2. We recommend using a front fork dust cover to protect the inner tube of the front fork. This prevents dust from entering as well as hard objects from hitting the inner tube.

◆ Brake Maintenance

1. Pad replacement:

Pads should be replaced if they become contaminated or have less than 2.5mm thickness. (Metal plate & wear material)

2. Before riding:

Check the pads for wear or contamination.

Check the hose for cracking, wear or deformation. Replace if necessary. Check if the brake system is operating correctly.

3. After riding:

Check the pads for wear or contamination.

Check the hose for cracking, wear or deformation. Replace if necessary. Check if the brake system is operating correctly.

4. At regular intervals:

Check the oil level in the reservoir. Lubricate the brake lever pivot with grease.

Check to make sure that all the bolts are tightened to the correct torque specifications.

◆ Riding Limitations

Following are some limitations needing riders' careful attention to ensure the mid motor does not overheat or become damaged from excessive loading:

- Do not attempt to ride up hills steeper than 15% grade.
- Use the pedals to assist the motor when climbing hills and accelerating from a stop
- Generally accelerate at a moderate pace, rather than aggressively.
- Avoid sudden starts and stops.

◆ Range and Content Beyond Warranty

1. The fault caused by failure to use maintenance or adjustment by the user according to the Operation Instructions;
2. The fault against which technical evaluation and analysis cannot be done because original state is destroyed due to refit, disassembly, repair and dismantling by the user himself;
3. Accessories other than that provided by "Roll Road" are used;
4. The fault caused by improper use or maintenance by the user or by accidents;
5. The bicycle without warranty card or the bicycle that is not corresponding to the warranty card;
6. The secondary fault caused by continuous use by the user after a fault occurrence.
7. The bicycle without certificate;
8. Unilateral amendment of invoice date or the part No. on bicycle.

◆ Online Resources

For more information on best practices, maintenance, and more, please visit the Roll Road Bikes website (<https://roll-road.com/>)

If you still have questions after checking out our online resources, please contact us in any of these ways:

Website: <https://roll-road.com>

E-mail: support@roll-road.com

Phone: +1 (860)800-9375