Product Specification

07/2014

Product Middle install intelligent LCD Display

Mode

Abbreviation C965A

Client

Customer

audit

Supplier Tianjin APT Development Co., Ltd.

Room 609, Hi-tech Building H, No.6 Huatian Road, Huayuan Industrial Area, Tianjin 300384, China

Tel TEL:+86 22 83715556
FAX:+86 22 83719955

Email yzhao@aptdevelop.com

1 Product Name

1.1 The Middle install intelligent LCD Display

1.2 Model:APT12LCD C965A

2 Suppliers

2.1 Tianjin APT Development Co., Ltd.

2.2 Email : yzhao@aptdevelop.com apt@aptdevelop.com

3 Electrical Parameters

- ◇ 24V/36V battery supply (48V optional)
- ◇ Rated operating current : 10mA
- ◇ Max operating current : 30mA
- ◇ Off leakage current < 1uA
- ◇ Max output current to controller : 50mA
- ◇ Operating temperature : -20~70°C
- ◇ Storage temperature : -30~80°C

4 Dimensions & Material

4.1 Product shell is ABS, transparent window is made with high strength Acrylic, the stiffness equals the tempered glass.

4.2 Dimensions : host/L90mm*W54mm*H13.3mm





5 Features

- ◇ Ergonomic external button design, easy to operate.
- ◇ **Speed display** : AVG SPEED, MAX SPEED, SPEED(Real-time).
- ◇ **Kilometer / Mile** : Can be set according to customers' habits.
- ◇ **Battery indicator**
- ◇ **The brightness of the backlight adjustable** : 5-sections.
- ◇ **9-level Assist** : 3-level/5-level/9-level, optional.
- ◇ **Mileage indicator** : Odometer/Trip distance/ Riding time.
- ◇ **Error code indicator**

- ◇ **Parameter settings** : Multiple parameter can be set through computer USB port, including [assist level numbers](#)/ [Wheel diameter](#) / [Speed limit...](#)

6 LCD instructions

The figure of LCD display see below:

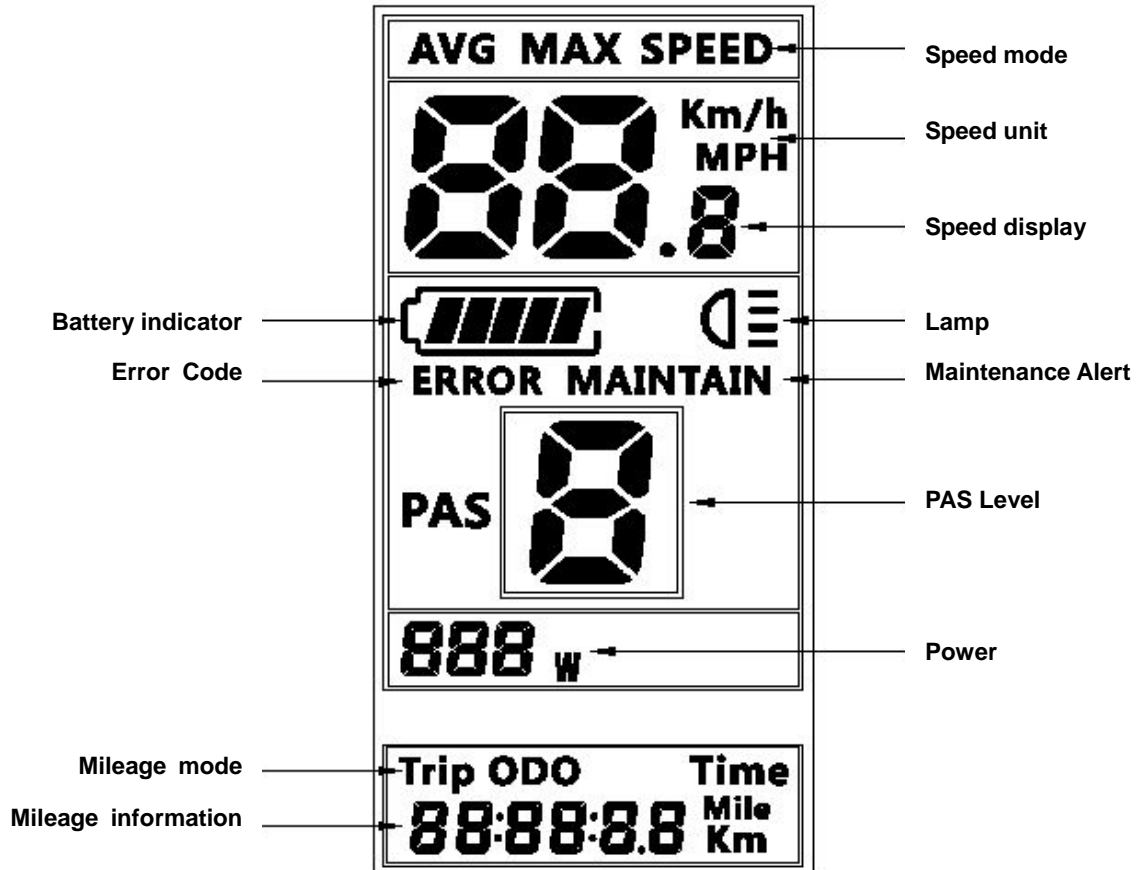

7 Functional Description

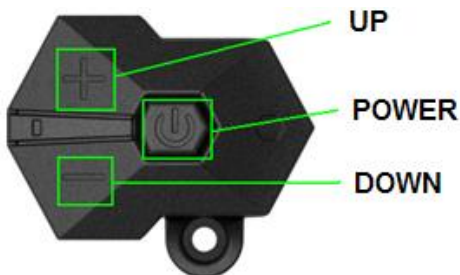

7.1 Power On/Off

Press and hold **Power** button for 1 second can turn on/off the display. The Display can automatically shut down when there is no operate & ride for **n** minutes(**n** could be 0~9).

7.2 Assist level operating

Short press **UP/DOWN** button can change the assist level, 0 for neutral. Level quantities can be adjusted according to the customer requirements.

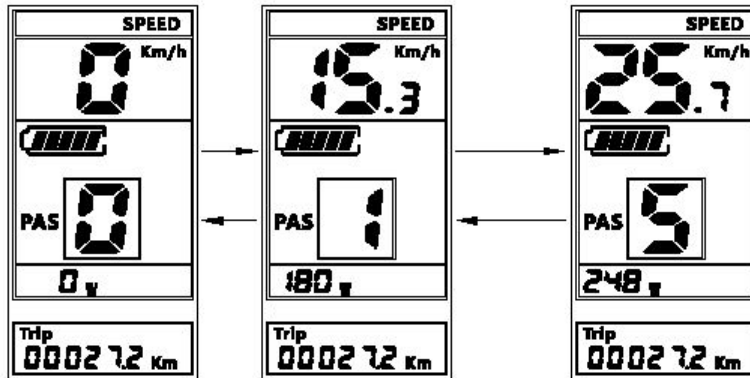

Assist operating

7.3 Speed mode switch& Mileage mode switch

Short press **POWER** button can change the speed mode& the mileage mode, Trip->Time->ODO-> **AVG Speed**->**MAX Speed**.

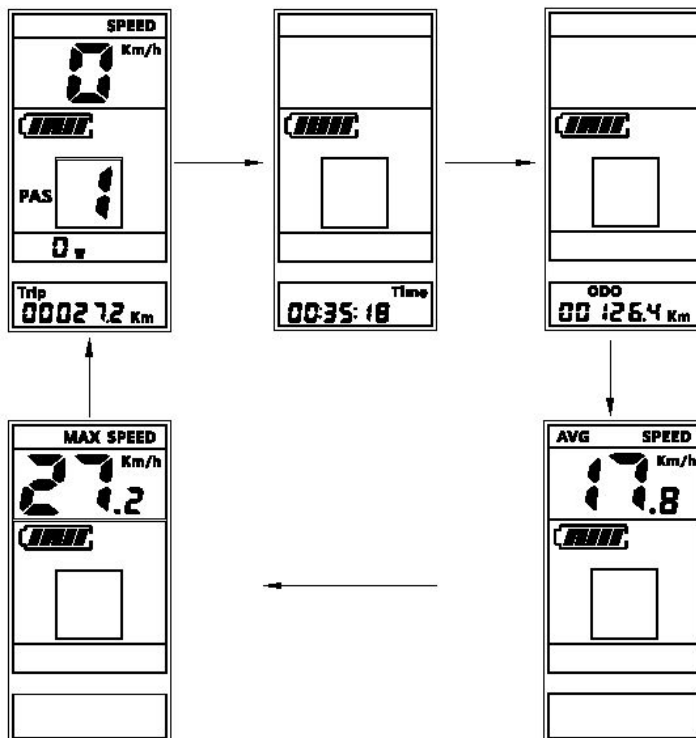

Speed mode switch& Mileage mode switch

*If there is no operation for 5 seconds, display will return Speed (Real-Time) display automatically.

7.4 Headlight/backlight On/Off

Press and hold **UP** button for 1 second can turn on/off the headlight/backlight.

The motor does not work when the battery voltage is low, Display still can keep the headlight on for a while when E-bike is in riding.

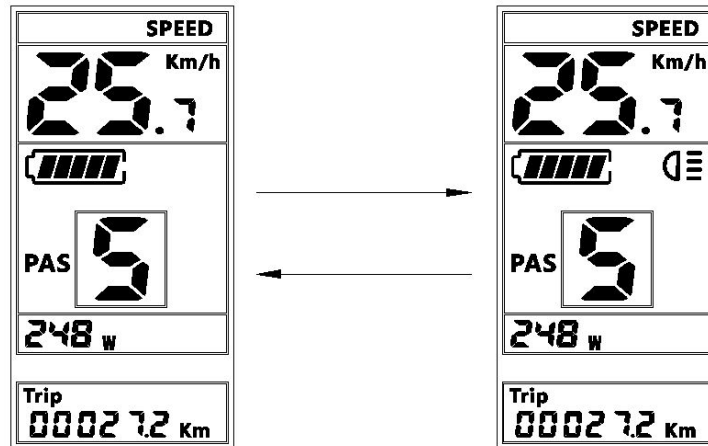

7.5 6km walk

Press and hold **DOWN** button for 1 second can get into walking mode, out of the mode when release the button.

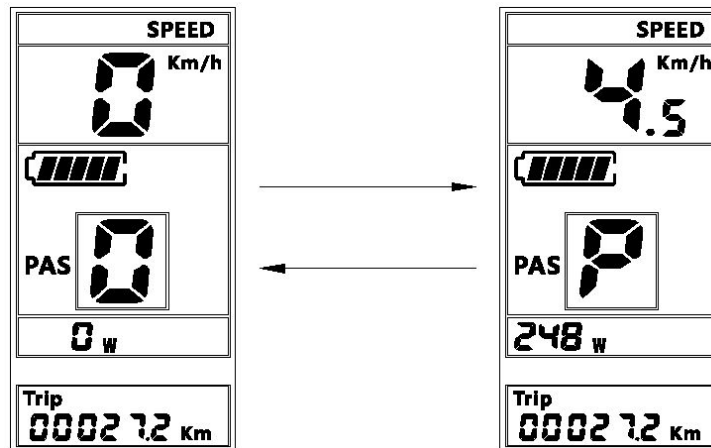

7.6 Battery indicator

Provide battery indicator. When the battery indicator shows under voltage, the battery needs to be charged.

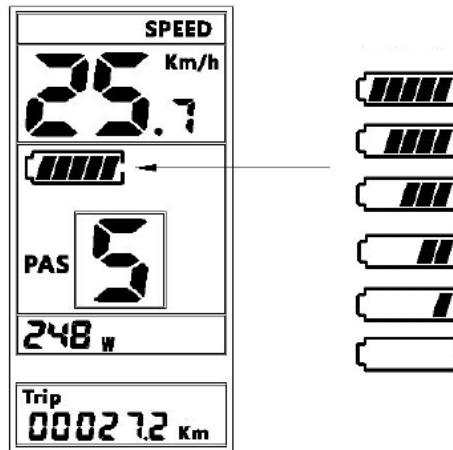

8 Basic Parameter setting

Press and hold **UP** & **DOWN** buttons together for 1 second can get into the Basic Parameter state, the parameter twinkles. The display will automatically quit the parameter setting state when there is no operation for 10 seconds.

The order of Basic parameters are as follows.

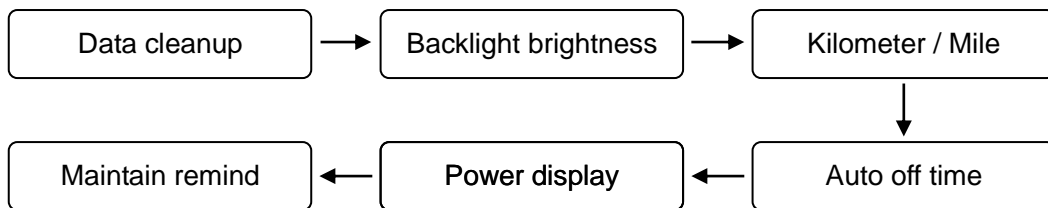

8.1 Data cleanup: The location of speed displays symbol **tC**, press **UP/DOWN** button rotate display the symbol **N/Y**, N: not need to be cleared, Y: needs to be cleared.

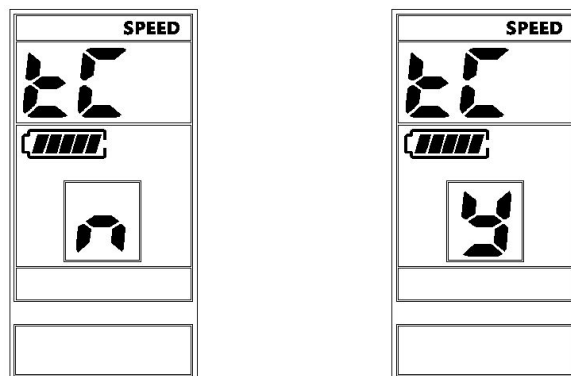

***Cleanup the several temporary data, the temporary data include AVG Speed / MAX Speed / Trip / Time.**

8.2 Backlight brightness : The location of speed displays symbol **bL1**, press

UP/DOWN button display symbol **1~5** to change the brightness of the backlight. The default value is **3**.

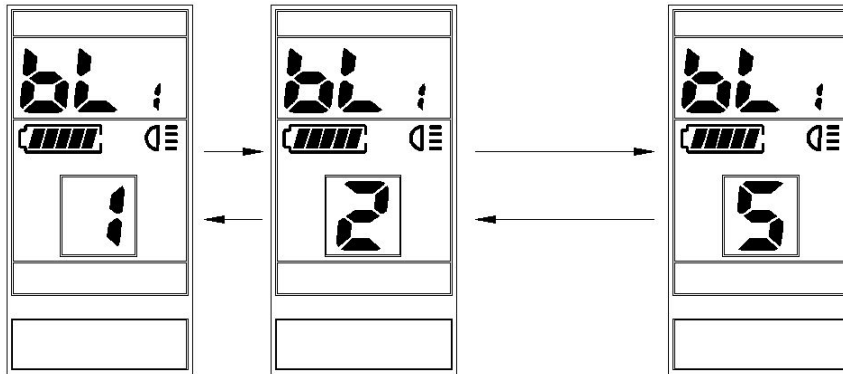

8.3 Kilometer / Mile: The location of speed displays symbol **S7**, press **UP/DOWN** button rotate display the symbol **km/h / MPH (Km / Mile)**.

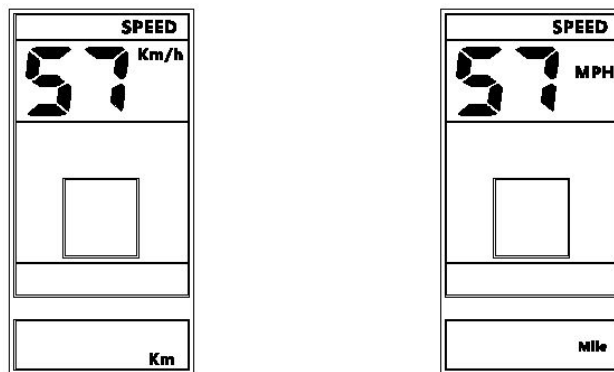

8.4 Auto off time : The location of speed displays symbol **OFF**, press **UP/DOWN** button to change the value from **1** to **9**, the number represent delay time (minutes) before display shutdown automatically, default value is 5 minutes.

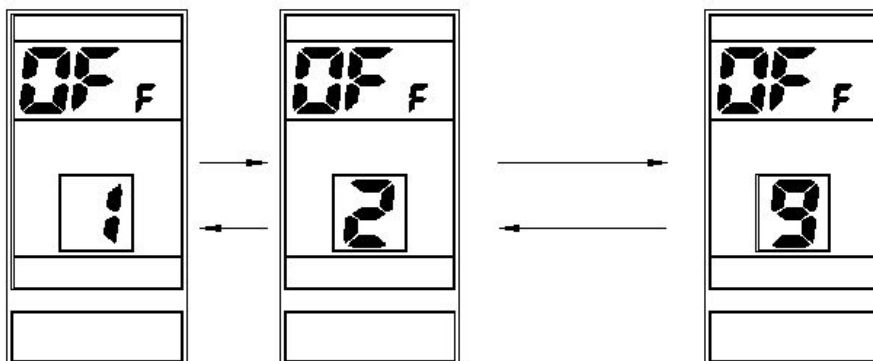

8.5 Power display: The location of speed display symbol **Pod**, press **UP/DOWN** button display symbol **0/1**, represent whether to show the power indicate on LCD. **0**

indicates Power display off, 1 indicates Power display on.

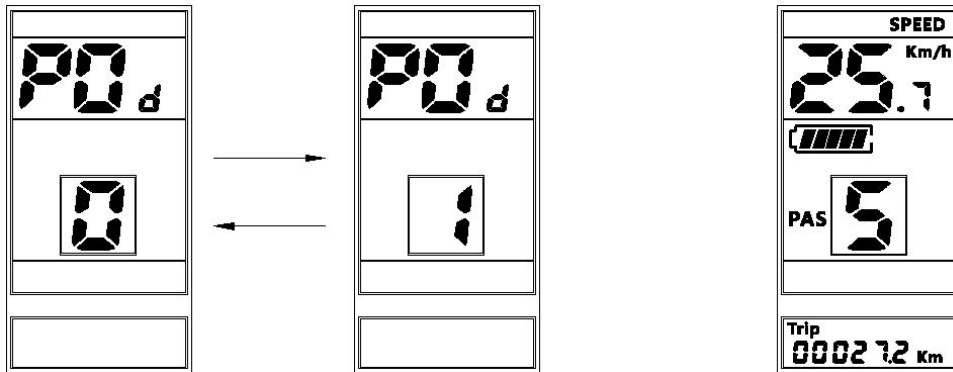

8.6 Maintain remind (Optional): The location of speed display symbol **nnA(ma)**, press **UP/DOWN** button rotate display symbol **0/1**, 0 represent maintain reminding off, 1 represent maintain reminding on.

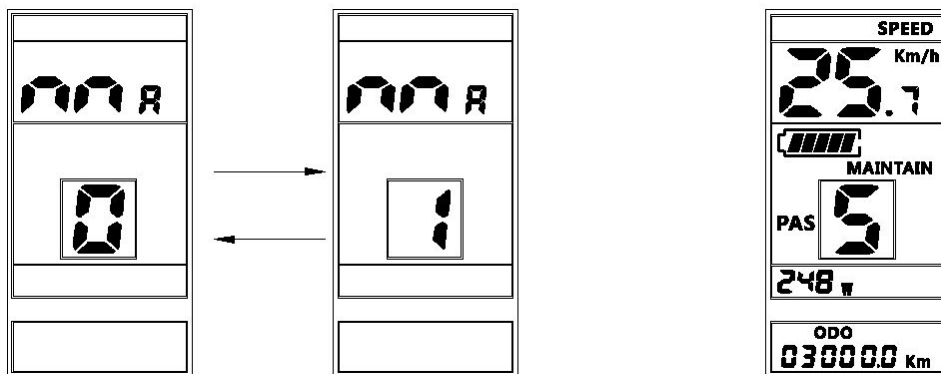

* The display can remind maintain information, according to mileage (ODO) . Display will display symbol **MAINTAIN** when the ODO accumulated more than setting mileage (this parameter can be set by dealers), the mileage symbol will flash for 4 seconds when the display power on.

9 Password Parameter setting

Press and hold **UP** & **DOWN** buttons together for 1 second can get into the Basic Parameter state, then press and hold **UP** & **DOWN** buttons together for 1 second again can get into the Password Parameter setting.

9.1 Password: The location of speeds displays symbol **PSd**, require to input passwords, press **UP/DOWN** buttons to change the password value (0-9), short press **POWER** button to switch the password item, password is 4 digits, the default password is "0512". Press **POWER** button when password adjustment is completed. Display will return Speed (Real-Time) display automatically if the password is incorrect. Correct

password will enter the **Wheel diameter set** item.

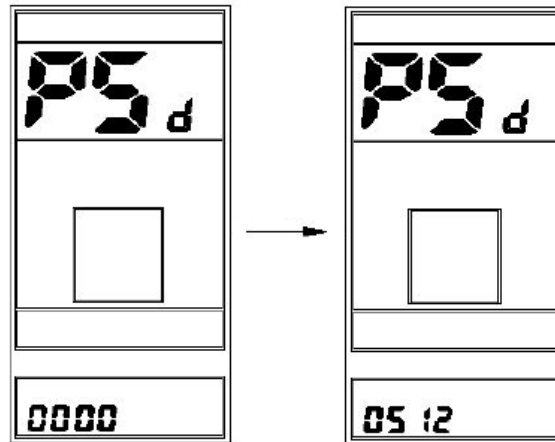

9.2 Wheel diameter : The location of speed display symbol **Wd**, press **UP/DOWN** button rotate display the symbol **16/18/20/22/24/26/700C/28/29**, value represents the diameter of the wheel (inch). Wrong wheel diameter setting will cause speed abnormal.

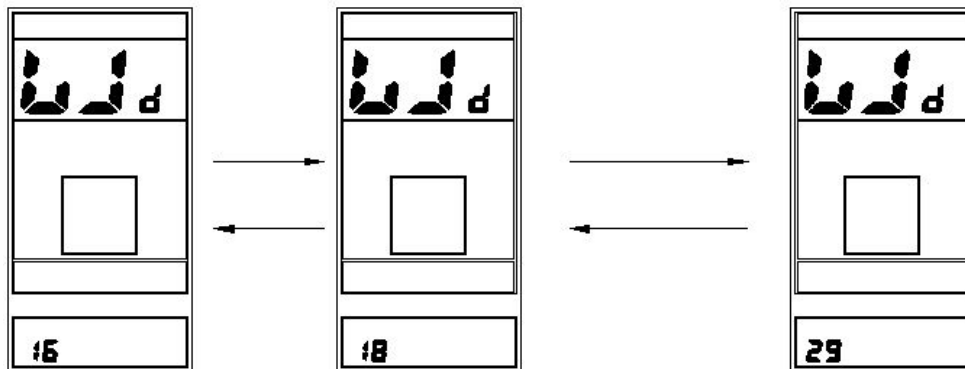

9.3 Speed limit set: The location of speed displays **speed limit value**, the default value is **27km/h**. Press **UP/DOWN** buttons to modify the value; the value can be set from 12 to 60km/h. Press **POWER** button to confirm when you finish the adjustment.

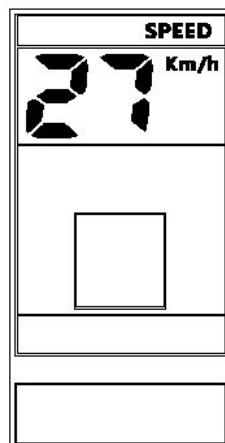

The maximum speed is restrict by the motor and controller, probably couldn't reach the setting value.

10 Error Code define

C965A display can give warning message when E-bike exist error, LCD display **ERROR** icon and the error code in speed position, error code is from 01H~FFH, the definition see the table below.

Error Code	Error description	Error display
0x01	Normal	No error
0x03	Brake signal	Display 03 on speed position
0x06	Low voltage protection	Display 06 on speed position
0x07	High voltage protection	Display 07 on speed position
0x08	Hall line of motor error	Display 08 on speed position
0x09	Phase line of the motor error	Display 09 on speed position
0x10	High temperature of controller	Display 10 on speed position
0x11	Controller's temperature sensor error	Display 11 on speed position
0x12	Current sensor error	Display 12 on speed position
0x13	Battery's temperature sensor error	Display 13 on speed position
0x14	Motor's temperature sensor error	Display 14 on speed position
0x21	Motor's speed sensor error	Display 21 on speed position
0x22	BMS communication error	Display 22 on speed position
0x23	Head light error	Display 23 on speed position
0x30	Communication error	Display 30 on speed position

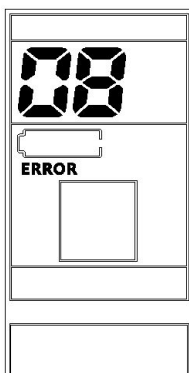

11 Assembly instructions

Please pay attention to the screw's torque value, damaged caused by excessive torque is not within the scope of the warranty.

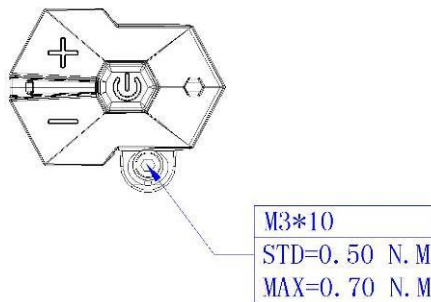
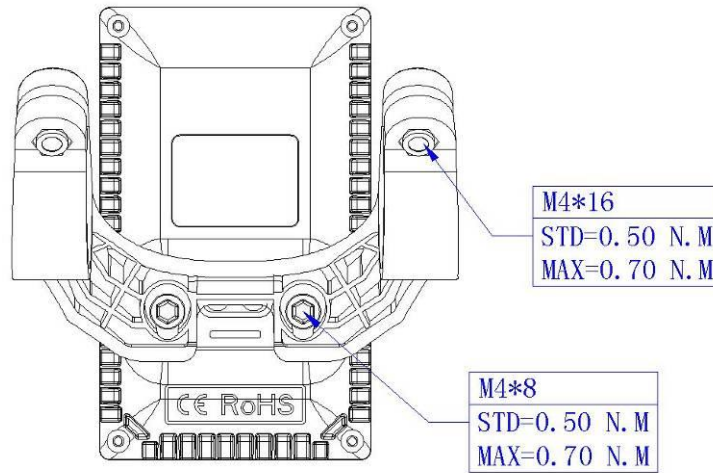

There are 2 directions for the clamp installation, forward or backward.

Different assembly methods will need different cable length.



Clamps suit for 3 size of handlebar, 31.8mm, 25.4mm, 22.2mm, there are transfer rings for 25.4mm and 22.2mm, transfer ring must be assembled with the special directions, pay attention to the green arrow below.

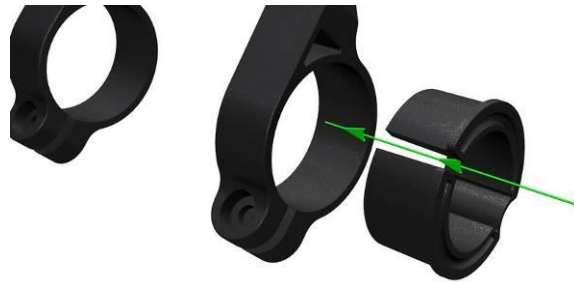

12 Output wire instructions

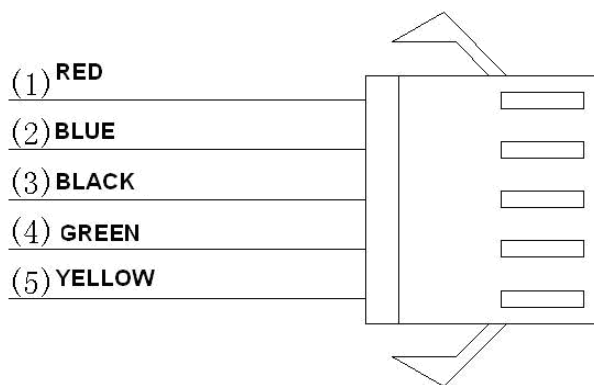

- 1、 Red wire : Anode(24v/36v)
- 2、 Blue wire : Power cord to the controller
- 3、 Black wire : GND
- 4、 Green wire : RxD (controller -> display)
- 5、 Yellow wire : TxD (display -> controller)

13 Assist level instructions

Assist level can be customized, the highest level is 9, common used level see the table below:

3 level	5 level	9 level	
0		0	No power assist
	1	1	
		2	
1	2	3	
		4	
	3	5	
2		6	
	4	7	
		8	

3	5	9	
---	---	---	--

14 Certification

CE / IP65 (water proof) / ROHS.