



SimpliFire[®]
Fire Made Simple

Electric

Linear Electric Fireplaces

Which Style is Right for You?

Scion Trinity

- Visually striking multisided design
- Install as three-sided (bay), two-sided (left- or right-corner), or single-sided
- Cleanest finish with concealed heat vents
- Tall, 15-inch high viewing for impactful room presence
- Extra-deep ember bed for an impressive media display
- Clear crystal media and driftwood logs with glowing embers come standard

Optional Accessories

- Floating mantel kit (for wall mount applications)
- ShadowGlo™ high-definition log sets

Scion

- Cleanest finish with concealed heat vents
- Tall, 15-inch high viewing for impactful room presence
- Extra-deep ember bed for an impressive media display
- Clear crystal media and driftwood logs with glowing embers come standard

Optional Accessories

- ShadowGlo high-definition log sets

Allusion Platinum

- Tall, 15-inch high viewing area with minimal frame
- Installs flush into a 2x6 wall, maximizing floor space
- Clear crystal and ceramic white stone media come standard

Optional Accessories

- Driftwood log set to enhance the allure
- Wall-mount kit available for quick and easy installation in any room

Allusion

- Flexibility to recess fully, recess partially, or hang on the wall

Optional Accessories

- Driftwood log set to enhance the allure

You deserve a choice, and we offer Best-Better-Good models to fit your budget and how you value features differently—all with SimpliFire dazzle and ease of use.

Best Scion Trinity



Best Scion



Better Allusion Platinum

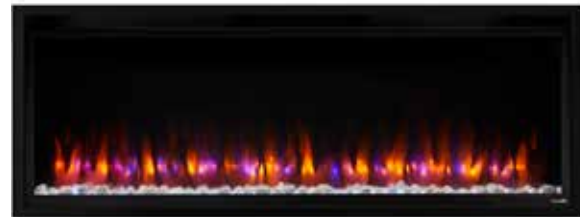

Good Allusion



Scion Trinity

Create an alluring atmosphere from any angle with the SimpliFire Scion Trinity electric fireplace. In three-sided, corner, or single-sided configurations, it adds stunning ambiance without the need for gas lines or venting.

Features

- Bring finishing materials right to the edge of the fireplace for a flush, built-in look
- No mesh screen or visible heat vents
- Accent lighting for greater warmth and ambiance
- Clear crystal media and driftwood logs with glowing embers come standard
- Available in 43" and 55" models



Scion Trinity 55" with floating mantel kit

Included media



Clear crystals



Driftwood logs

Optional ShadowGlo log sets



Alpine Timber logs



Natural Birch logs



Scion Trinity 55" with Driftwood logs

Scion Trinity Series

Model	BTU Output	Width (A)		Height (B)		Depth (C)		Viewing Area (D x E)
		Unit	Framing	Unit	Framing	Unit	Framing	
SF-SCT43-BK	5,000	42-1/2" [1080]	42-3/4" [1086]	22" [559]	22-1/4" [565]	11-1/4" [286]	11-1/2" [194]	42-1/2" x 14-3/4" [1080 x 375]
SF-SCT55-BK	5,000	54-1/2" [1384]	54-5/8" [1387]	22" [559]	22-1/4" [565]	11-1/4" [286]	11-1/2" [194]	54-1/16" x 14-3/4" [1373 x 375]

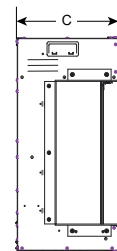

Side View

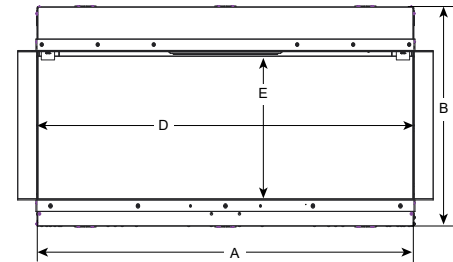

Front View



Side View

Scion

Distinctly express your style. Seamlessly finish your wall and bring materials right to the edge of the fireplace for sleek look. Concealed vents, dynamic flame and vibrant lights bring your room to life, clean and simple.

Features

- Bring finishing materials right up to the edge of the fireplace for a flush, built-in look
- No mesh screen or visible heat vents
- Accent lighting for greater warmth and ambiance
- Clear crystal media and driftwood logs with glowing embers come standard
- Available in 43", 55", and 78" wide models



Scion 55" linear shown with orange flame and Driftwood logs

Included media



Clear crystals



Driftwood logs

Optional ShadowGlo log sets



Alpine Timber logs



Natural Birch logs

Model	BTU Output	Width (A)		Height (B)		Depth (C)		Viewing Area (D x E)
		Unit	Framing	Unit	Framing	Unit	Framing	
SF-SC43-BK	5,000	44-1/2" [1130]	45" [1143]	23-7/8" [606]	24-1/4" [616]	7-5/8" [194]	7-5/8" [194]	41-1/2" x 15" [1054 x 381]
SF-SC55-BK	5,000	56-1/2" [1435]	57" [1448]	23-7/8" [606]	24-1/4" [616]	7-5/8" [194]	7-5/8" [194]	53-1/4" x 15" [1353 x 381]
SF-SC78-BK	5,000	80" [2032]	80-1/2" [2045]	23-7/8" [606]	24-1/4" [616]	7-5/8" [194]	7-5/8" [194]	76-7/8" x 15" [1953 x 381]

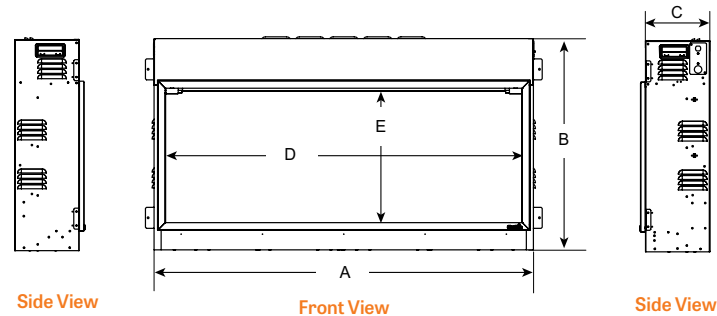

Side View

Front View

Side View

Allusion Platinum

Creating an elegant focal point in your home has never been easier. Designed with comfort and ambiance in mind, the Allusion Platinum provides an impressive viewing area within a minimal frame.

Features

- Clear crystal media and ceramic white stones come standard
- Available in 50", 60", and 72" wide models
- Flexible installation: Fully recess for a flush look, or surface-mount with the optional wall-mount kit



Wall Mounted



Fully Recessed



Allusion Platinum Linear Series

Allusion Platinum 60" linear shown with blue flame and ceramic white stones

Included media



Clear crystals



Ceramic white stones

Optional media



Driftwood Logs

Model	BTU Output	Width			Height			Depth		Viewing Area (F x G)
		Front (A)	Back (B)	Framing	Front (C)	Back (D)	Framing	Unit (E)	Framing*	
SF-ALLP50-BK	5,000	52-5/16" [1329]	50-1/2" [1295]	51" [1295]	20-7/16" [519]	19-3/8" [492]	19-1/2" [495]	5-5/8" [143]	2" x 6"	48" x 15" [1219 x 381]
SF-ALLP60-BK	5,000	62-5/16" [1583]	60-1/2" [1537]	61" [1549]	20-7/16" [519]	19-3/8" [492]	19-1/2" [495]	5-5/8" [143]	2" x 6"	58" x 15" [1473 x 381]
SF-ALLP72-BK	5,000	74-5/16" [1888]	72-1/2" [1842]	73" [1854]	20-7/16" [519]	19-3/8" [492]	19-1/2" [495]	5-5/8" [143]	2" x 6"	70" x 15" [1778 x 381]

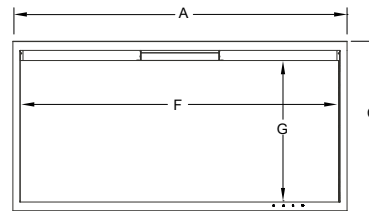

Front View

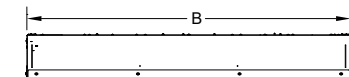

Top View

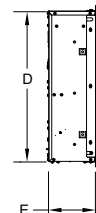

Side View

Allusion

The Allusion electric fireplace series embraces modern design by combining linear proportions with a multitude of flame and LED ember bed lighting themes.

Features

- Clear crystal media creates the illusion of a soothing fire rising from a lighted ember bed
- Available in 40", 48", 60" or 84" wide models
- Simple touch controls on the fireplace front for added convenience
- Flexible installation: fully or partially recess or hang on the wall



Fully Recessed



Partially Recessed



Wall Mounted



Allusion 48" linear shown with blue orange flame, white ember bed lighting and clear crystal media

Optional media



Driftwood Logs



Ceramic Stones

Model	BTU Output	Width			Height			Depth		Viewing Area (F x G)
		Front (A)	Back (B)	Framing*	Front (C)	Back (D)	Framing*	Unit (E)	Framing*	
SF-ALL40-BK	5,000	40-1/2" [1029]	35" [889]	36" [914]	20-1/4" [515]	17-13/16" [453]	18-1/8" [461]	5-15/16" [151]	2" x 6"	31-3/8" x 11-1/4" [797 x 285]
SF-ALL48-BK	5,000	48-7/16" [1230]	42-13/16" [1088]	44-5/16" [1126]	20-1/4" [515]	17-13/16" [453]	18-1/8" [461]	5-15/16" [151]	2" x 6"	39-3/8" x 11-1/4" [1000 x 285]
SF-ALL60-BK	5,000	60-1/4" [1530]	54-5/8" [1388]	56-1/8" [1426]	20-1/4" [515]	17-13/16" [453]	18-1/8" [461]	5-15/16" [151]	2" x 6"	51-3/16" x 11-1/4" [1300 x 285]
SF-ALL84-BK	5,000	83-7/8" [2130]	78-1/4" [1988]	79-1/2" [2019]	20-1/4" [515]	17-13/16" [453]	18-1/8" [461]	5-15/16" [151]	2" x 6"	74-7/8" x 11-1/4" [1902 x 285]

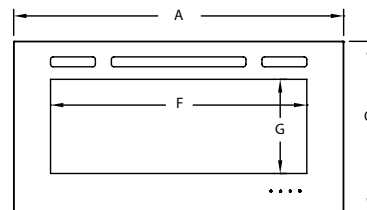

Front View

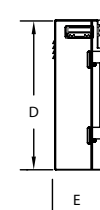

Side View

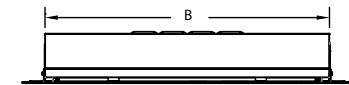

Top View

Linear Electric Fireplace Features and Options

Aesthetics

- Safely place a television or artwork directly above the fireplace
- Multiple media options for the look you want
- Four flame color choices, 13 ember bed color choices for complete customization

Control

- Enjoy year-round, with or without heat
- Intuitive, multifunction remote for control at your fingertips
- Standard thermostat and timer provide added control

Economical

- Adjustable heat that costs just pennies an hour to operate
- Zone heat your space to remain comfortable while reducing your monthly heating bills
- Up to 5,000 BTUs provides two-stage supplemental heat

Model	Scion Trinity 43", 55"	Scion 43", 55", 78"	Alluson Platinum 50", 60", 72"	Alluson 40", 48", 60", 84"
Flame Colors	4	4	4	4
Ember Bed Colors	13	13	13	13
Accent Lighting	YES	YES	NO	NO
Remote	YES	YES	YES	YES
Thermostat Mode	YES	YES	YES	YES
Included Media	-Clear Crystals -Driftwood Logs	-Clear Crystals -Driftwood Logs	-Clear Crystals -Ceramic White Stones	-Clear Crystal Media
Optional Media	ShadowGlo™ Logs: -Alpine Timber -Natural Birch	ShadowGlo Logs: -Alpine Timber -Natural Birch	-Driftwood Logs	-Driftwood Logs -Ceramic White Stones
Installation Method	-Built-In 3-Sided (Bay) -Built-In 2-Sided (Left/Right Corner) -Built-In Single-Sided -Wall Mount (with optional floating mantel kit)	-Built-In Flush	-Fully Recess 2x6 Framing -Wall Mount (with optional kit)	-Recessed Flush in 2x6 Framing -Semi-Recess in 2x4 Framing -Wall Mount (wall mount included)
Electrical Connection	-15 AMP, 120V/60 Hz -Hardwire or Plug-In	-15 AMP, 120V/60 Hz -Hardwire Only	-15 AMP, 120V/60 Hz -Hardwire or Plug-In	-15 AMP, 120V/60 Hz -Hardwire or Plug-In
Heat Output	Up to 5,000 BTUs	Up to 5,000 BTUs	Up to 5,000 BTUs	Up to 5,000 BTUs

Thirteen ember bed colors

Ember beds are lit with the glow from long-lasting LED lights and provides 13 individual color options as well as the option to continuously rotate through all the colors.

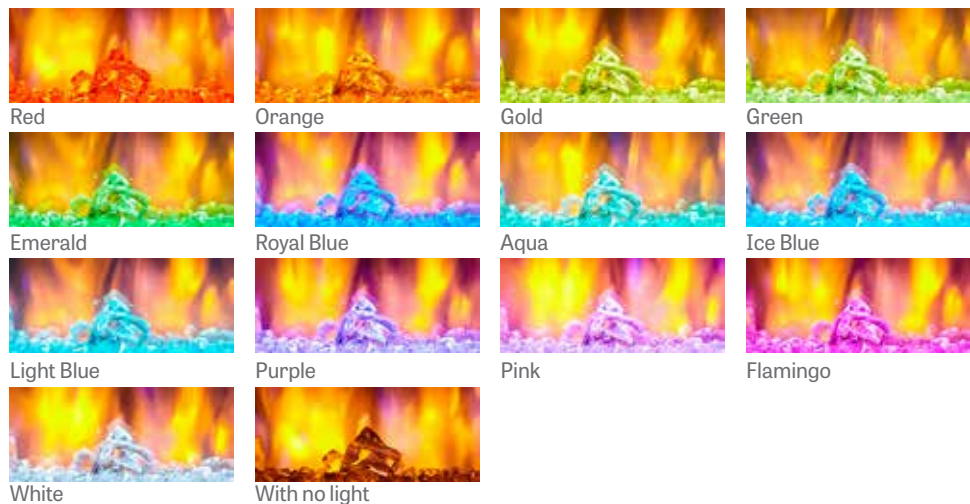

Four flame colors

LED flame technology delivers enhanced energy efficiency in four flame colors.

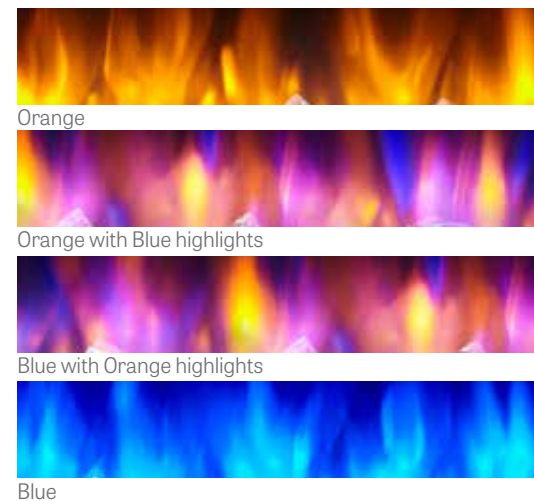

Multi-Function Remote

An intuitive multifunction remote control comes standard.



