



Please consult the manufacturer's installation manual for all details and requirements before making a final design layout decision.

Allusion Platinum 60" Recessed Linear Electric Fireplace

MODEL	FRONT WIDTH		BACK WIDTH		FRONT HEIGHT		BACK HEIGHT		DEPTH		VIEWING AREA
	Actual	Framing	Actual	Framing	Actual	Framing	Actual	Framing	Actual	Framing	
SF-ALLP60-BK	62-5/16" [1583]	61" [1549]	60-1/2" [1537]	61" [1549]	20-7/16" [519]	19-1/2" [495]	19-3/8" [492]	19-1/2" [495]	5-5/8" [143]	2x6	58" x 15" [1473 x 381]

FRONT VIEW

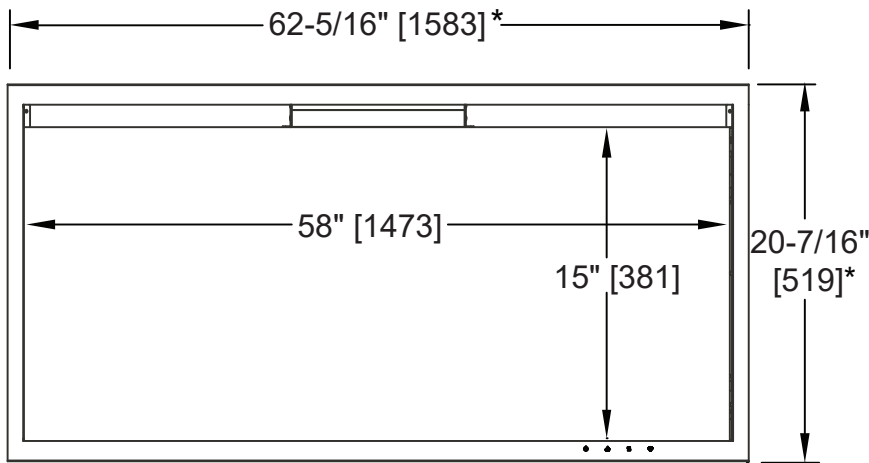

SIDE VIEW



TOP VIEW

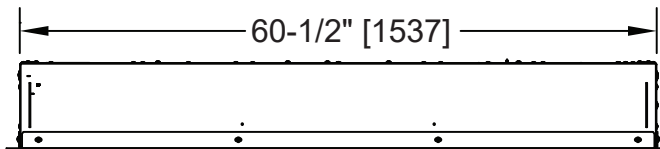

ELECTRICAL ACCESS

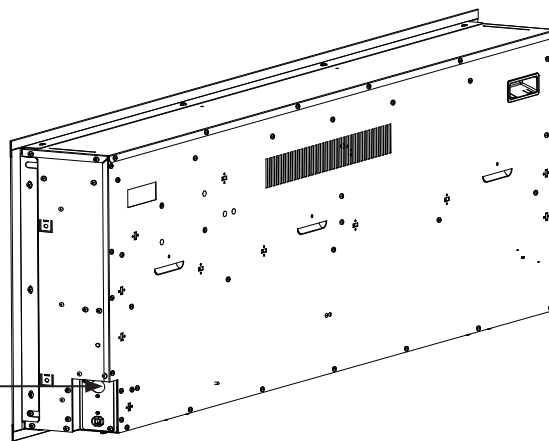

ELECTRICAL CONNECTION REQUIREMENTS

CIRCUIT	CONNECTION METHOD	BTUS
15 AMP, 120V/60 Hz	Hardwire or plug-in	5,000

MINIMUM CLEARANCES TO COMBUSTIBLES

AREA	CLEARANCES
SIDES	0"
FLOOR	0"
TOP TO MANTEL	5/8" [16]
BACK	0"
FRONT	36" [914]

FINISHING DIMENSIONS

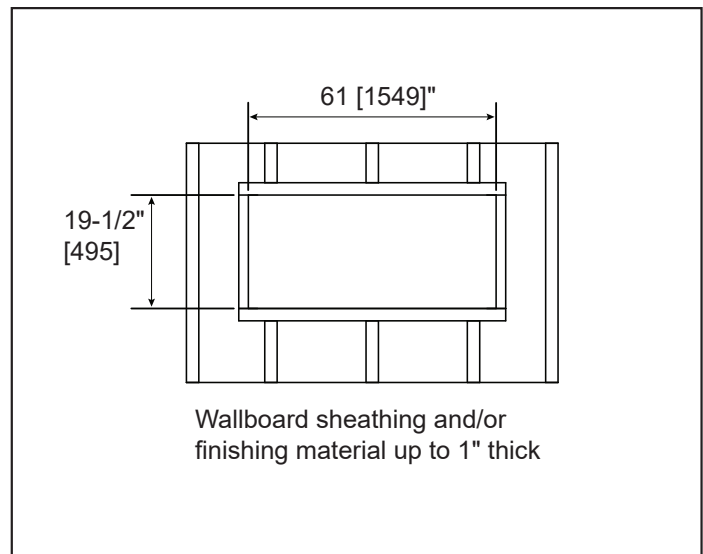

APPLIANCE LOCATION

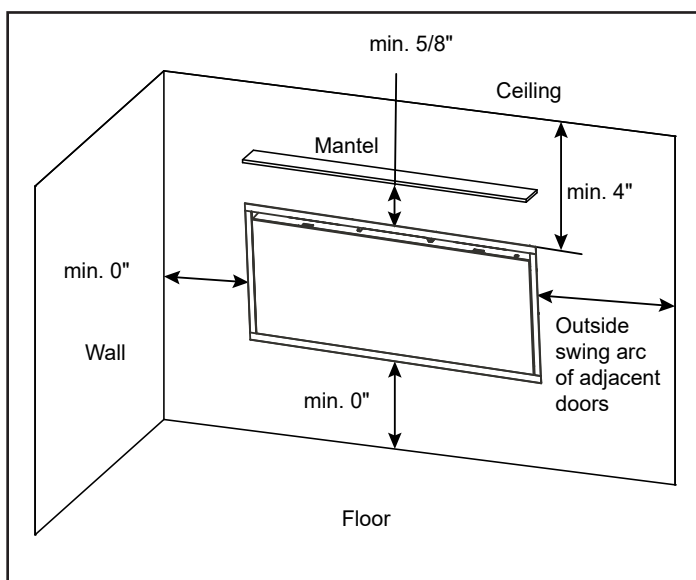

MANTEL PROJECTIONS

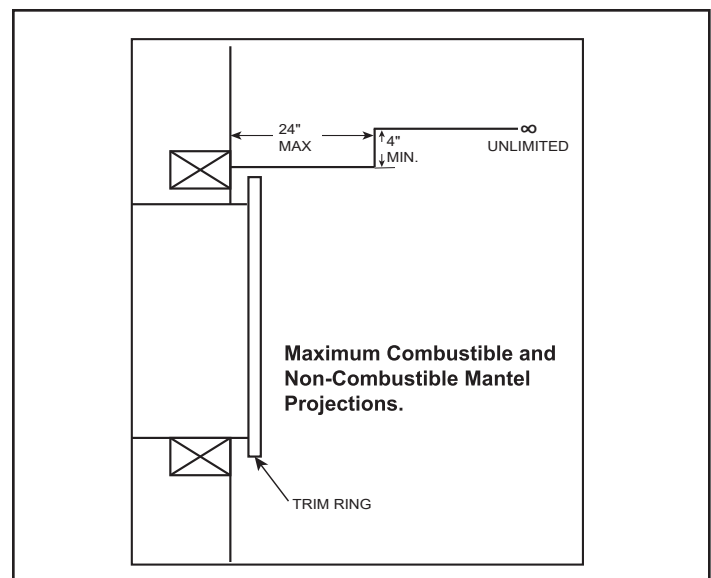

PRODUCT LISTING CODES	
US	CSA 22.2 No 46-M1988
INTERNATIONAL	CSA 22.2 No 46-M1988

Product information provided is not complete and is subject to change without notice. Product installation must adhere strictly to instructions accompanying product to avoid risk of fire and potential injury.