

INSTALLATION INSTRUCTIONS

OPTIONAL STEPPER MOTOR KITS MODEL: RVKP-1 | RVKN-1

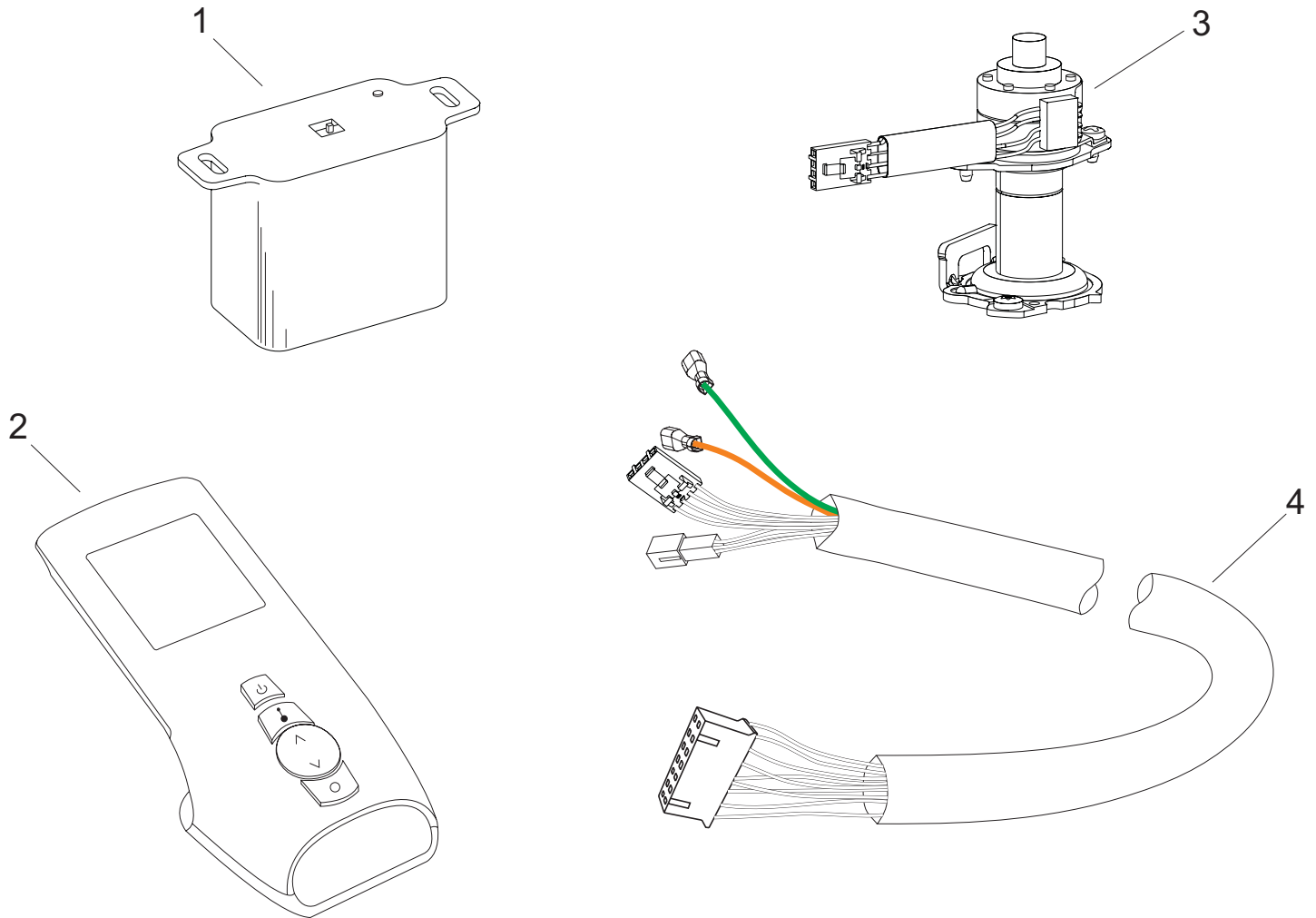

PARTS LIST		
Index No.	Part No.	Description
1	R11235	Receiver
2	R11236	Transmitter
3	R11381	Stepper Motor - Natural
3	R11382	Stepper Motor - Propane
4	R11237	Wire Harness
Not Shown	-	AAA Batteries (Qty 3)
Not Shown	-	AA Batteries (Qty 4)
Not Shown	-	Hook and Loop tape

INSTALLATION INSTRUCTIONS

Tools Needed: T-15 Torx Security Bit & Driver

1. Shut off electricity and gas to fireplace.
2. Remove decorative front and louvers (if applicable. See your Fireplace Owner's Manual for more information).
3. Remove the two screws securing the HI/LO knob to the valve with a T-15 Torx Security Bit. **See Figure 1.**

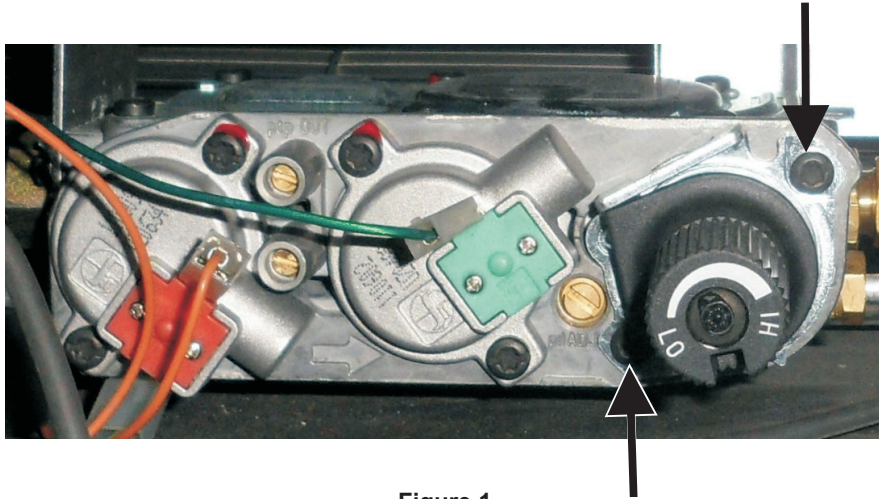

Figure 1

4. Remove the HI/LO knob assembly and screws from the unit.
5. Remove the existing diaphragm and discard.
6. Install the stepper motor to the valve with the two 1/2 inch screws provided with the kit. **See Figure 2.**
(Refer to the instructions included with the stepper motor kit.)

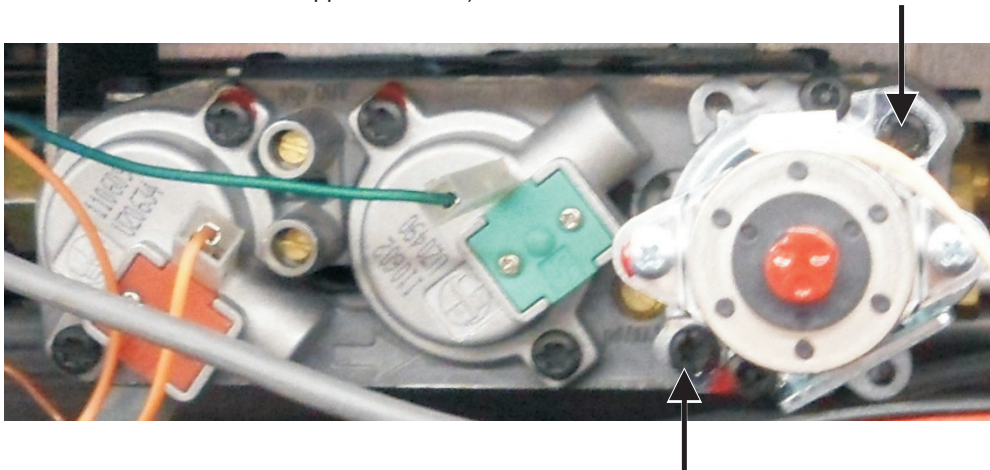

Figure 2

7. Disconnect the ON/OFF switch and black wires from wiring harness connected to the white and green wires from the control module.
8. Attach wiring harness included with the kit to the stepper motor.
The four prong connector on the stepper motor attaches to the four prong receiver on the new wiring harness.
9. Plug the green wire tagged "TH" on the new wiring harness into the green wire that was removed from the switch.
10. Plug the white wire tagged "TPTH" on the new wiring harness into the white wire that was removed from the switch.
11. Disconnect AC adaptor from DC supply in the module wire harness.
12. Connect DFC supply connection (red and black wires) to the DC supply connection (red and black wires) on the module wire harness.
13. Plug AC adaptor to DC adaptor connection into new wire harness.
14. Connect the receiver terminal wires to the remote receiver included with the kit.
15. Place four "AA" batteries into the remote receiver and three "AAA" batteries into the remote transmitter.
16. Attach the remote receiver to the underside of the unit with hook and loop tape.
17. Replace decorative front and louvers (if applicable. See your Fireplace Owner's Manual for more information).
18. Reattach gas and electricity lines to fireplace.

NOTICE: Split flow wires (pink and blue) are not to be used.

NOTICE: DFC supply wires (red and black) are not to be used)

OPERATION INSTRUCTIONS

TECHNICAL DATA

Remote Control

Supply voltage	4.5 V (three 1.5 V AAA batteries)
Ambient temperature ratings	0-50°C (32 - 122°F)
Radio frequency	315 MHz
Receiver	
Supply voltage	6.0 V (four 1.5 V AA batteries)
Ambient temperature ratings	0-60°C (32 - 140°F)
Radio frequency	315MHZ

WARNING

The transmitter and receiver are radio frequency devices. Placing the receiver in or near metal may severely reduce the signal range.

ATTENTION

- Turn "off" the main gas supply of the appliance during installation or maintenance of the receiver.
- Place the receiver's 3 position slider switch in the "off" position during installation or maintenance.
- Turn "off" main gas supply to the appliance prior to removing or reinserting the batteries in the receiver.

WARNING

Fire Hazard. Can cause severe injury or death. The Receiver causes ignition of the appliance. The appliance can turn on suddenly. Keep away from the appliance burner when operating the remote system or activating manual bypass of the remote system.

CAUTION

Property Damage Hazard. Excessive heat can cause property damage. The appliance can stay lit for many hours. Turn off the appliance if it is not going to be attended for any length of time. Always place the Transmitter where children can not reach it.

OPERATION INSTRUCTIONS (CONT'D)

TRANSMITTER (REMOTE CONTROL WITH LCD DISPLAY)

The Proflame Transmitter uses a streamline design with a simple button layout and informative LCD display **Figure 3**.

The Transmitter is powered by 3 AAA type batteries. A Mode Key is provided to Index between the features and a Thermostat Key is used to turn on/off or index through thermostat functions **Figures 3 and 4**.

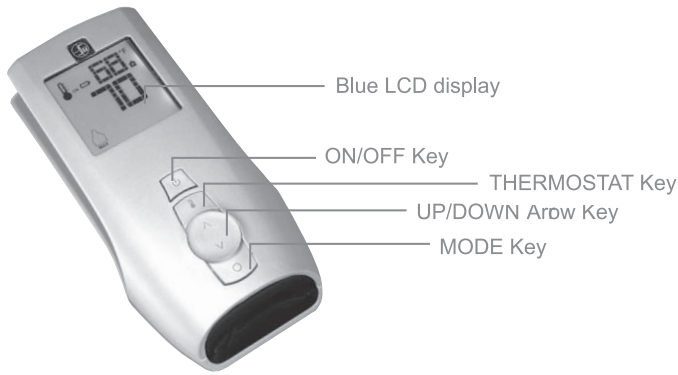

Figure 3 - Proflame Transmitter

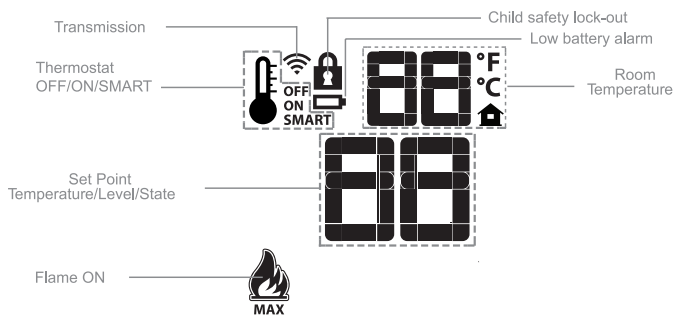

Figure 4 - Transmitter LCD display

RECEIVER

The Proflame Receiver **Figures 5a and 5b** connects directly to the gas valve and stepper motor with a wiring harness. The Receiver is powered by 4 AA type batteries. The Receiver accepts commands via radio frequency from the Transmitter to operate the appliance in accordance with the particular Proflame system configuration. The Receiver three position slider switch can be set to one of three positions: ON (Manual Override), Remote (Remote control) or Off.

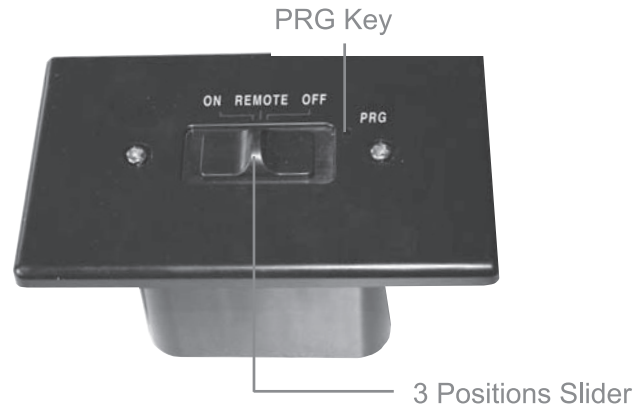

Figure 5a - Proflame Receiver Body Front

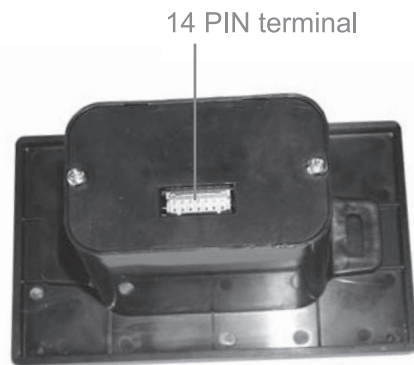

Figure 5b - Proflame Receiver Body Back

OPERATION INSTRUCTIONS (CONT'D)

OPERATING PROCEDURE

Initializing the System for the first time

Install the 4 AA batteries into the receiver battery bay. Note the polarity of battery and insert into the battery bay as indicated on the Battery cover (+/-). Place the 3 position slider switch in the "Remote" position.

Using the end of a paper clip, or other similar object, insert the end of the paper clip into the hole marked "PRG" on the Receiver front cover. The Receiver will "beep" three (3) times to indicate that it is ready to synchronize with a Transmitter. Install the 3 AAA type batteries in the Transmitter battery bay, located on the base of the Transmitter. With the batteries already installed in the Transmitter, push the On button. The Receiver will "beep" four times to indicate the Transmitter's command is accepted and sets to the particular code of that Transmitter. The system is now initialized.

Temperature indication Display

With the system in the "OFF" position, press the Thermostat Key and the Mode Key at the same time. Look at the LCD screen on the Transmitter to verify that a C or F is visible to the right of the Room Temperature display. See Figures 6 and 7.

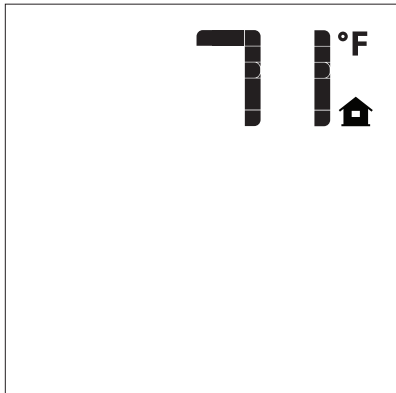

Figure 6 - Fahrenheit

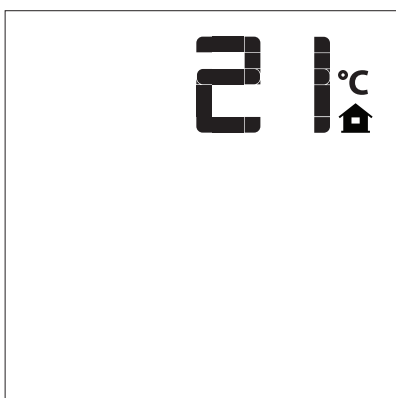

Figure 7 - Celsius

Turn on the Appliance

Press the ON/OFF Key on the Transmitter. The Transmitter display will show all active Icons on the screen. At the same time the Receiver connects the thermopile to the gas valve millivolt coil and the appliance main burner turns on. A single "beep" from the Receiver will confirm reception of the command.

Turn off the Appliance

Press the ON/OFF Key on the Transmitter. The Transmitter LCD display will only show the room temperature and Icon **Figure 8**. At the same time the Receiver disconnects the thermopile from the gas valve millivolt coil and the appliance burner turns off. A single "beep" from the Receiver confirms reception of the command.

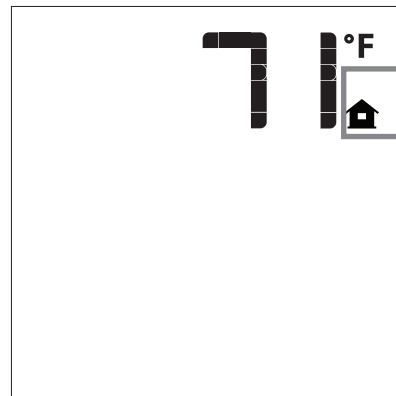

Figure 8

OPERATION INSTRUCTIONS (CONT'D)

Remote Flame Control

The Proflame GTM has six (6) flame levels. With the system on, and the flame level at the maximum in the appliance, pressing the Down Arrow Key once will reduce the flame height by one step until the flame is turned off. The Up Arrow Key will increase the flame height each time it is pressed. If the Up Arrow Key is pressed while the system is on but the flame is off, the flame will come on in the high position **Figure 9 - 12**. A single “beep” will confirm reception of the command.

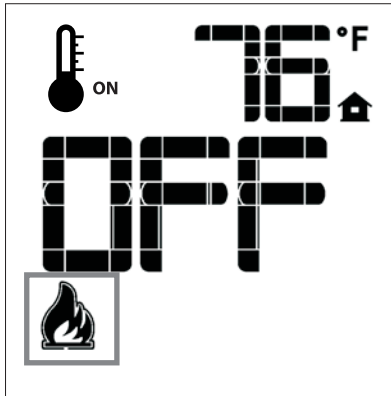

Figure 9

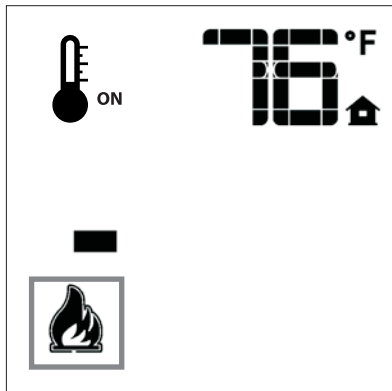

Figure 10

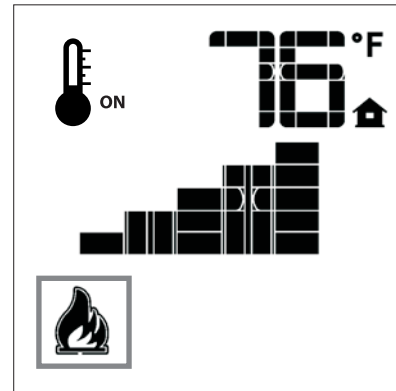

Figure 11

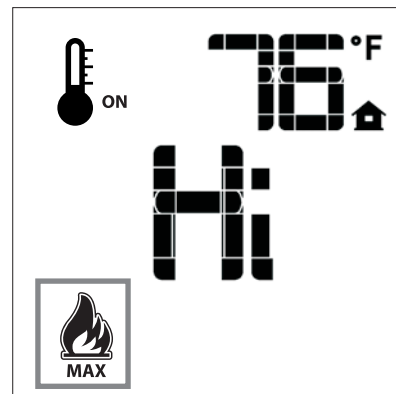

Figure 12

OPERATION INSTRUCTIONS (CONT'D)

ROOM THERMOSTAT (Transmitter Operation)

The Remote Control can operate as a room thermostat. The thermostat can be set to a desired temperature to control the comfort level in a room.

To activate this function, press the Thermostat Key **Figure 3**. The LCD display on the Transmitter will change to show that the room thermostat is "ON" and the set temperature is now displayed **Figures 13a and 13b**. To adjust the set temperature, press the Up or Down Arrow Keys until the desired set temperature is displayed on the LCD screen of the Transmitter.

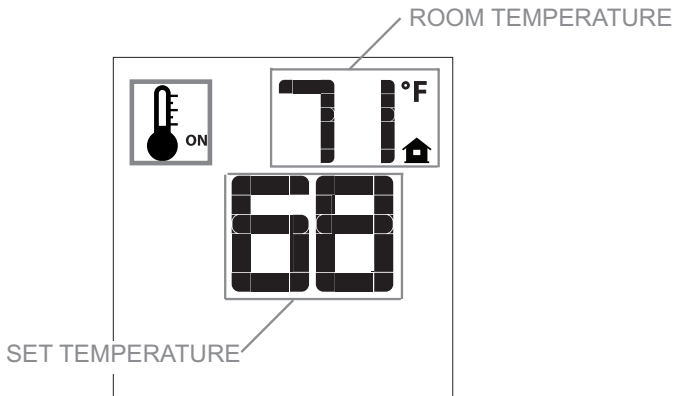

Figure 13a

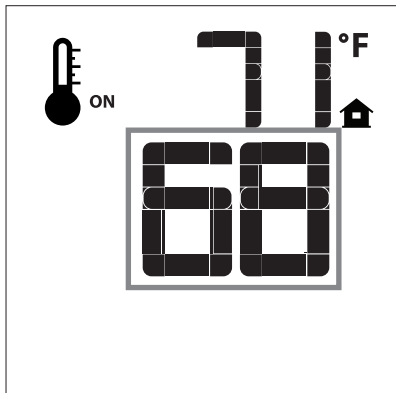

Figure 13b

Smart Thermostat (Transmitter Operation)

The Smart Thermostat function adjusts the flame height in accordance to the difference between the set point temperature and the actual room temperatures. As the room temperature gets closer to the set point the Smart Function will modulate the flame down.

To activate this function, press the Thermostat Key **Figure 5** until the word "SMART" appears to the right of the temperature bulb graphic **Figure 16**. To adjust the set temperature, press the Up or Down arrow Keys until the desired set point temperature is displayed on the LCD screen of the Transmitter **Figure 17**.

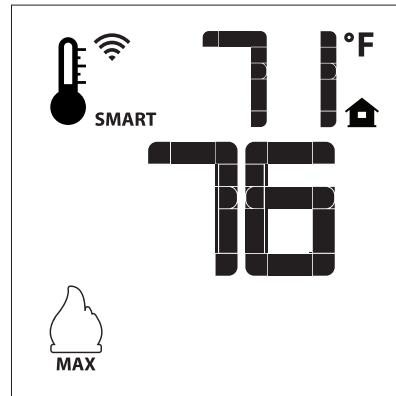

Figure 14

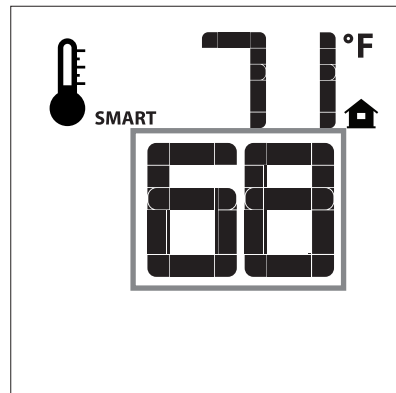

Figure 15

OPERATION INSTRUCTIONS (CONT'D)

KEY LOCK

This function will lock the keys to avoid unsupervised operation. To activate this function, press the MODE and the UP Arrow Key at the same time **Figure 16**. To de-activate this function, press the MODE and the UP Arrow Key at the same time.

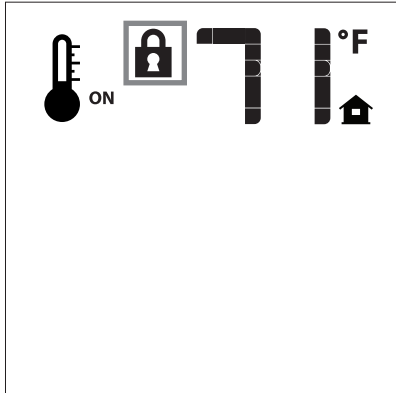

Figure 16

LOW BATTERY POWER DETECTION

Transmitter

The life span of the remote control batteries depends on various factors: quality of the batteries used, the number of ignitions of the appliance, the number of changes to the room thermostat set point, etc.

When the Transmitter batteries are low, a Battery Icon will appear on the LCD display of the Transmitter **Figure 17** before all battery power is lost. When the batteries are replaced this Icon will disappear.

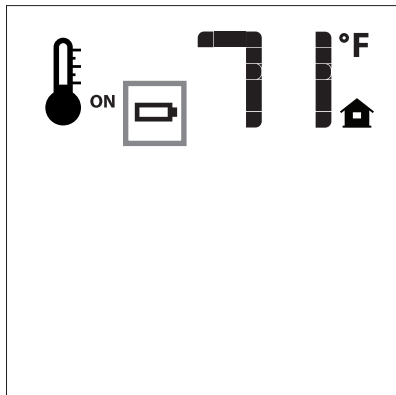

Figure 17

Receiver

The life span of the Receiver batteries depends on various factors: quality of the batteries used, the number of ignitions of the appliance, the number of changes to the room thermostat set point, etc. When the Receiver batteries are low, No "beep" will be emitted from the Receiver when it receives an On/Off command from the Transmitter. This is an alert for a low battery condition for the Receiver. When the batteries are replaced the "beep" will be emitted from the Receiver when the ON/OFF Key is pressed (See Initialization of The System).

MANUAL BYPASS OF THE REMOTE SYSTEM

If the batteries of the Receiver or Transmitter are low or depleted, the appliance can be turned on manually by sliding the three position slider switch on the Receiver to the ON position.

This will bypass the remote control feature of the system and the appliance main burner will come on if the gas valve is in the "On" position.

OPERATION INSTRUCTIONS (CONT'D)

5.25 VDC ELECTRONIC CONTROL VALVE

The electronic control valve system includes the ability to switch the pilot from a standing pilot mode to an intermittent pilot mode.

- **IP Mode** - In the Intermittent Pilot mode, when the unit is turned ON, it will cause spark to the pilot, light the pilot, then allow the burner to light. When the unit is turned OFF, both the burner and pilot will be OFF.
- **CPI Mode** - In the Continuous Pilot mode, the pilot remains ON continuously even when the burner is turned OFF.

NOTICE: A small toggle switch is located on a bracket that is used to switch from IP (upward position) to the CPI (downward position). See Figure 18.

When the unit is turned to ON, the electrical current will energize a spark to the pilot igniter. Once the pilot sensor heats up (after a few seconds), the valve will be energized, allowing gas to flow to the burner.

1. Follow the SAFETY and LIGHTING INSTRUCTIONS for Intermittent Pilot controls found in this manual, and on labels found in the control compartment located in the lower cavity of the appliance.
2. During the operating season (or in power outage periods), it is recommended that the pilot remain in the CPI (standing pilot mode) to reduce cold start issues, and/or conserve battery backup power during a power outage.
3. The gas valve has inlet and outlet pressure taps as shown in Figure 18. Refer to appliance Installation Instructions for gas pressure requirements.

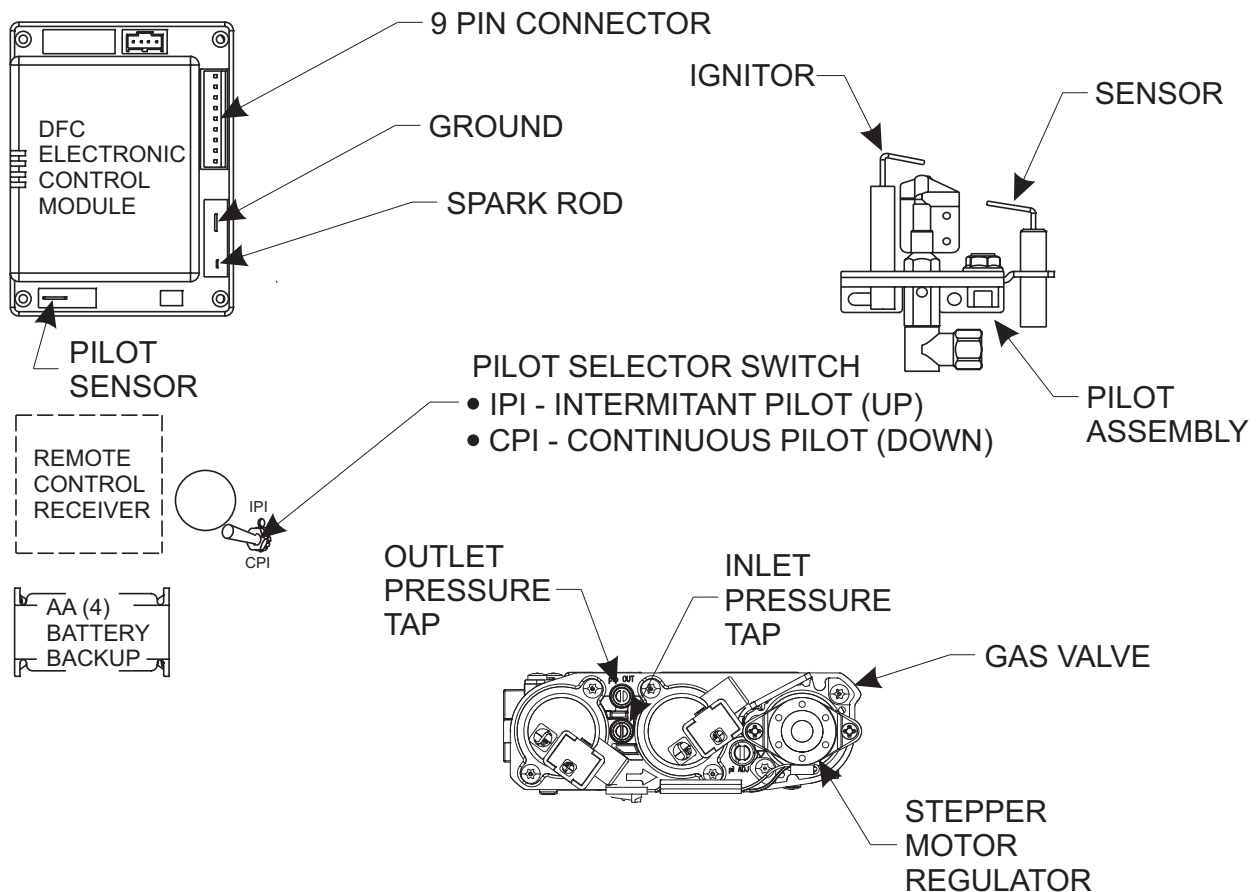

Figure 18

MASTER PARTS DISTRIBUTOR LIST

To Order Parts Under Warranty, please contact your local Empire dealer. See the dealer locator at www.empirecomfort.com. To provide warranty service, your dealer will need your name and address, purchase date and serial number, and the nature of the problem with the unit.

To Order Parts After the Warranty Period, please contact your dealer or one of the Master Parts Distributors listed below. This list changes from time to time. For the current list, please click on the Master Parts button at www.empirecomfort.com. Please note: Master Parts Distributors are independent businesses that stock the most commonly ordered Original Equipment repair parts for Heaters, Grills, and Fireplaces manufactured by Empire Comfort Systems Inc.

Dey Distributing

1401 Willow Lake Boulevard
Vadnais Heights, MN 55101

Phone: 651-490-9191

Toll Free: 800-397-1339

Website: www.deydistributing.com

Parts: Heater, Hearth and Grills

F. W. Webb Company

200 Locust Street
Hartford, CT 06114

Phone: 860-722-2433

Toll Free: 800-243-9360

Fax: 860-293-0479

Toll Free Fax: 800-274-2004

Websites: www.fwwebb.com & www.victormfg.com

Parts: Heater, Hearth and Grills

East Coast Energy Products

10 East Route 36
West Long Branch, NJ 07764

Phone: 732-870-8809

Toll Free: 800-755-8809

Fax: 732-870-8811

Website: www.eastcoastenergy.com

Parts: Heater, Hearth and Grills

HOW TO ORDER REPAIR PARTS

Parts Not Under Warranty

Parts can be ordered through your Service Person, Dealer, or a Master Parts Distributor. See this page for the Master Parts Distributors list. For best results, the **service person or dealer** should order parts through the distributor. Parts can be shipped directly to the **service person/dealer**.

Warranty Parts

Warranty parts will need a proof of purchase and can be ordered by your Service Person or Dealer. Proof of purchase is **required** for warranty parts.

All parts listed in the Parts List have a Part Number. When ordering parts, first obtain the Model Number and Serial Number from the name plate on your equipment. Then determine the Part Number (**not** the Index Number) and the Description of each part from the following illustration and part list. Be sure to give all this information . . .

Appliance Model Number _____ Part Description _____

Appliance Serial Number _____ Part Number _____

Type of Gas (Propane or Natural) _____

Do not order bolts, screws, washers or nuts. They are standard hardware items and can be purchased at any local hardware store.

Shipments contingent upon strikes, fires and all causes beyond our control.

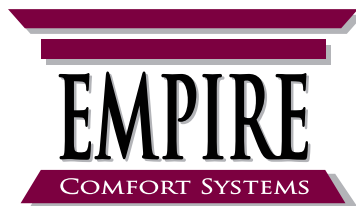

Empire Comfort Systems Inc.
Belleville, IL

If you have a general question
about our products, please e-mail
us at info@empirecomfort.com.

If you have a service or repair
question, please contact your dealer.

SINCE 1932

www.empirecomfort.com