

# ROMA FIRE & WATER BOWL

GFRC CONCRETE

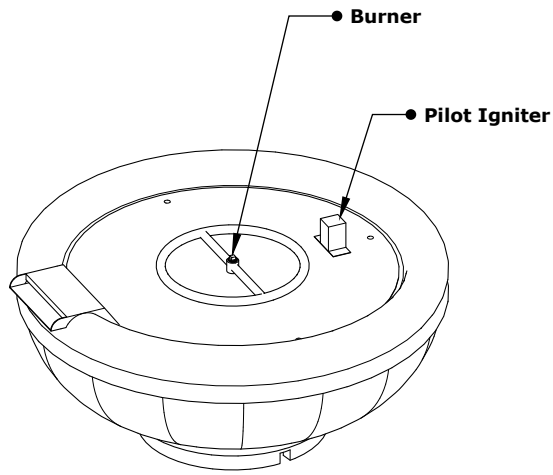

**ISOMETRIC VIEW**

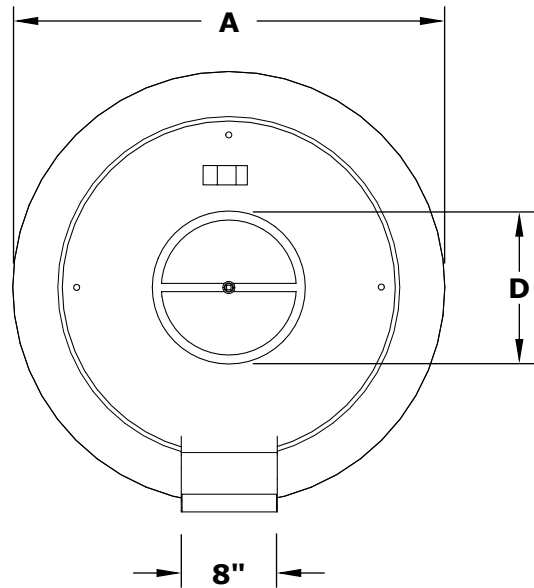

**TOP VIEW**

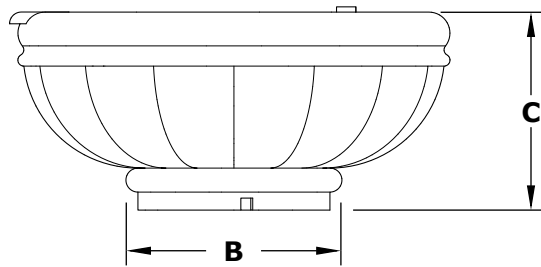

**RIGHT SIDE VIEW**

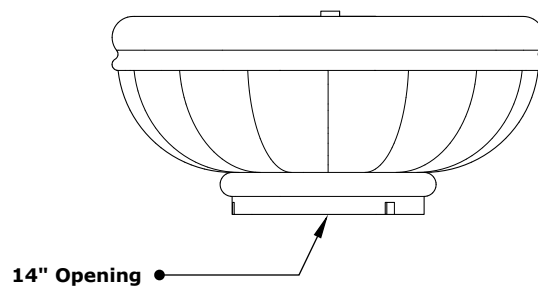

**BACK SIDE VIEW**

PART NUMBER	A	B	C	D	GPM	BTU
OPT-ROMFW24	24"	9"	10"	8"	7-10	65,000
OPT-ROMFW24E12V	24"	9"	10"	8"	7-10	65,000
OPT-ROMFW36	36"	18"	16"	12"	7-10	65,000
OPT-ROMFW36E12V	36"	18"	16"	12"	7-10	65,000

Fire Pit Material: GFRC Concrete  
 Pan Material: 304 Stainless Steel  
 Burner Material: 304 Stainless Steel  
 Standard 2" Depth on all pans  
**110V ELECTRONIC IGNITION**  
 ANSI Z21.97-(2017) / CSA 2.41-(2017)



Match Lit Unit Includes: Pan, Burner, Gas Orifice, Gas Hoses, Key Valve, Key,  
 110v Ignition Unit Includes: Pan, Burner, Gas Orifice, Gas Hoses, Key Valve, Key, Plug & Play Electronic Valve, Pilot Igniter.