



102745-XT electric fireplace  
with optional log set

# ELECTRIC FIREPLACES

DEEP • EXTRA TALL • EXTRA SLIM

**Remui**



# EXTRA SLIM



102735-XS electric fireplace



102765-XS electric fireplace



35"



45"



55"



65"

The Remii NEW Extra Slim is available in four sizes, so you'll find a unit that is perfect for any space in your home, business or commercial space.

Boasting our FIRE & ICE® Flame presentation with three color LED light strips allowing for multi-color flame options. With just a click of the included remote control, choose from blue, rose, violet, yellow or orange colored flames. The Extra Slim model comes standard with Canyon Brown and Ocean Blue fireglass media. Additional media options available for purchase, please see back page for more details.

## KEY FEATURES: Extra Slim



Heater & Fan



Rated for indoor & outdoor use including bathrooms



Perfect for zone heating. Approx. 500 sq. ft. 4800 BTUs



Hard-wire ready  
Thermostat hard-wire ready



Very thin - only 4" in depth



FIRE & ICE® Flame presentation. Three light strips allow for yellow, orange, blue, violet & rose colored flames

	102735-XS	102745-XS	102755-XS	102765-XS
Volts	120 AC 60 Hz	120 AC 60 Hz	120 AC 60 Hz	120 AC 60 Hz
Watts	1500 max	1500 max	1500 max	1500 max
No Heater	25 watts	25 watts	25 watts	25 watts
Motor Heater	19 watts	19 watts	19 watts	19 watts
Appliance Width Appliance Height	34-1/8" 19-7/8"	44-1/8" 19-7/8"	54-1/8" 19-7/8"	64-1/8" 19-7/8"
Appliance Depth	4"	4"	4"	4"
Gross Weight	46.3 lbs.	62 lbs.	86 lbs.	108 lbs.
Plug Location	Left Side	Left Side	Left Side	Left Side
Cord Length	70-7/8"	70-7/8"	70-7/8"	70-7/8"
Rough Wall Opening	34" x 20-3/8"	44" x 20-3/8"	54" x 20-3/8"	64" x 20-3/8"
BTU	4800	4800	4800	4800

## IN THE BOX



Canyon Brown Media



Ocean Blue Media



\*Remote control may not be exactly as shown

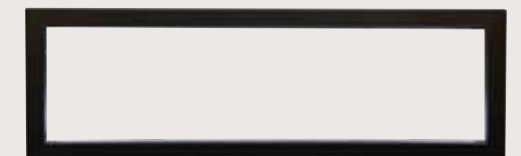





102755-XS electric fireplace



102745-XS electric fireplace

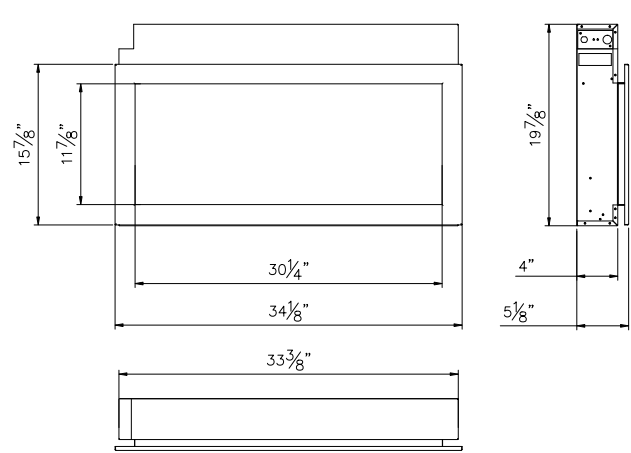

102735-XS

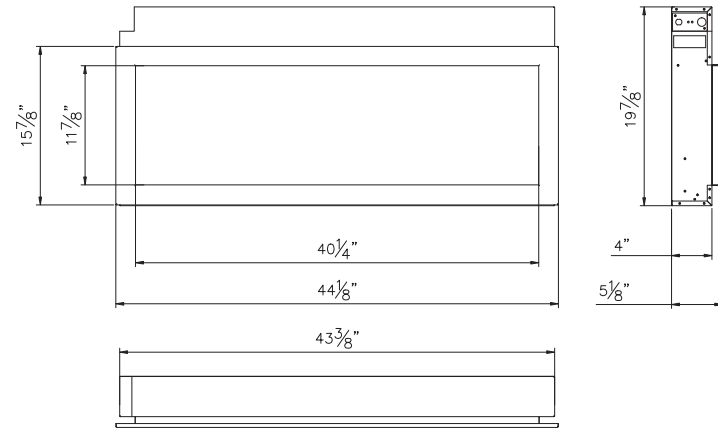

102745-XS

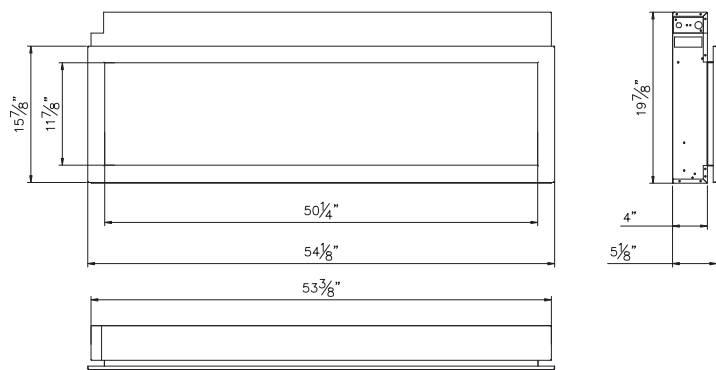

102755-XS

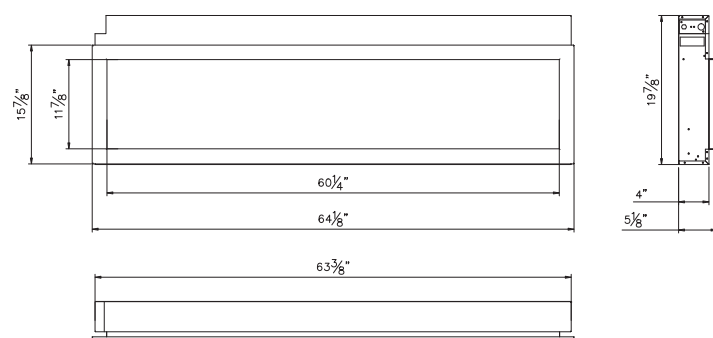

102765-XS



102765-XS electric fireplace



# DEEP



102755-DE electric fireplace with optional log set



102745-DE electric fireplace



45"



55"



65"

The Remii Deep Series of built-in electric fireplaces have been designed to give you the maximum in flexibility in selecting a unit that perfectly suits your needs.

Our stylish electric fireplace will be a focal point in any room, indoor or outdoor. The Deep Series gives you a 12" depth and multiple length options, as well as giving you the ability to install your fireplace with your choice of finishing material built right to the glass for a "clean face" design or using the provided black metal surround. Your choice – your design!

Featuring the vibrant Fire & Ice® flame set, with just a click of your remote you can easily change the flame colour from blue to purple to violet to orange or yellow. Additional media options available for purchase, please see back page for more details.

## KEY FEATURES: Deep



**FIRE & ICE® Flame presentation.** Three light strips allow for yellow, orange, blue, violet & rose colored flames



**Heater & Fan**  
Flame operates with or without heat



**Perfect for zone heating.**  
Approx. 500 sq. ft. 4800 BTUs



**Hard-wire ready**  
Thermostat hard-wire ready



**Illuminate decorative media** like never before with ambient canopy lighting in 13 colors



**Deep 12"** comes with Canyon Brown and Ocean Blue fireglass media, and black steel surround that can be installed if preferred

	102745-DE	102755-DE	102765-DE
Volts	120 AC 60 Hz	120 AC 60 Hz	120 AC 60 Hz
Watts	1500 max	1500 max	1500 max
No Heater	25 watts	25 watts	25 watts
Motor Heater	19 watts	19 watts	19 watts
Appliance Width	44-1/8"	54-1/8"	64-1/8"
Appliance Height	23-5/8"	23-5/8"	23-5/8"
Appliance Depth	11-7/8"	11-7/8"	11-7/8"
Gross Weight	103.6 lbs.	121 lbs.	143 lbs.
Plug Location	Left Side	Left Side	Left Side
Cord Length	70-7/8"	70-7/8"	70-7/8"
Rough Wall Opening	45" x 25"	55" x 25"	65" x 25"
BTU	4800	4800	4800

## IN THE BOX



Canyon Brown Media

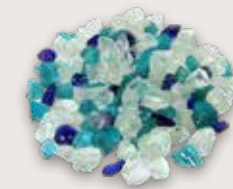

Ocean Blue Media

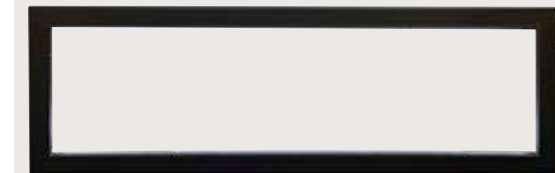

Additional media options available for purchase including life like log sets, please see back page for more details.





102765-DE electric fireplace



102745-DE electric fireplace

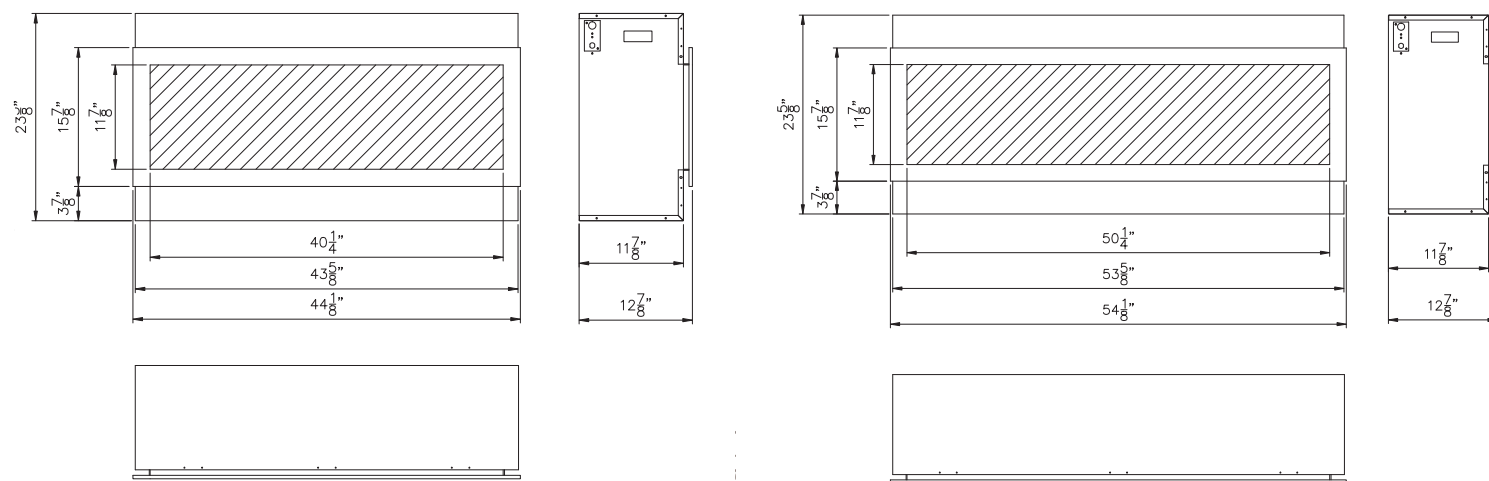

102745-DE

102755-DE

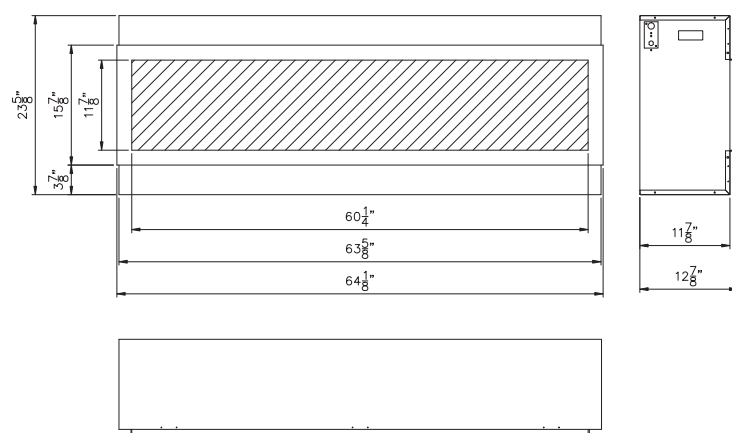

102765-DE



102755-DE electric fireplace



# EXTRA TALL



102765-XT electric fireplace



102755-XT electric fireplace



45"



55"









65"

Featuring an Extra Tall viewing area that is 18" in height! That is 6" taller than our other Panorama models. It has a deep media tray and comes standard with Canyon Brown and Ocean Blue fireglass media. Additional media options available for purchase, please see back page for more details.

Built with Amantii's FIRE & ICE® Flame presentation made of three color LED light strips allowing for multi-color flame options. With just a click of the included remote control, choose from blue, rose, violet, yellow or orange colored flames.

### KEY FEATURES: Extra Tall

-  Heater & Fan
-  Rated for indoor & outdoor use including bathrooms
-  Perfect for zone heating. Approx. 500 sq. ft. 4800 BTUs
-  Hard-wire ready  
Thermostat hard-wire ready
-  Glass viewing area is 18" in height
-  FIRE & ICE® Flame presentation. Three light strips allow for yellow, orange, blue, violet & rose colored flames

	102745-XT	102755-XT	102765-XT
Volts	120 AC 60 Hz	120 AC 60 Hz	120 AC 60 Hz
Watts	1500 max	1500 max	1500 max
No Heater	25 watts	25 watts	25 watts
Motor Heater	19 watts	19 watts	19 watts
Appliance Width	43-5/8"	53-5/8"	63-5/8"
Appliance Height	29-1/2"	29-1/2"	29-1/2"
Appliance Depth	12-5/8"	12-5/8"	12-5/8"
Gross Weight	94.6 lbs.	110 lbs.	127.6 lbs.
Plug Location	Left Side	Left Side	Left Side
Cord Length	70-7/8"	70-7/8"	70-7/8"
Rough Wall Opening	45" x 30"	55" x 30"	65" x 30"
BTU	4800	4800	4800

### IN THE BOX



Canyon Brown Media



Ocean Blue Media

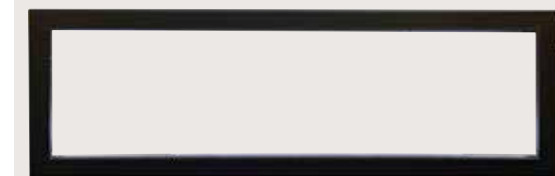

Additional media options available for purchase including life like log sets, please see back page for more details.



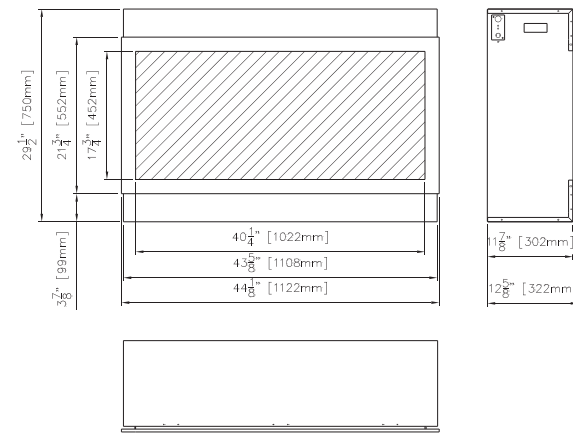

102745-XT

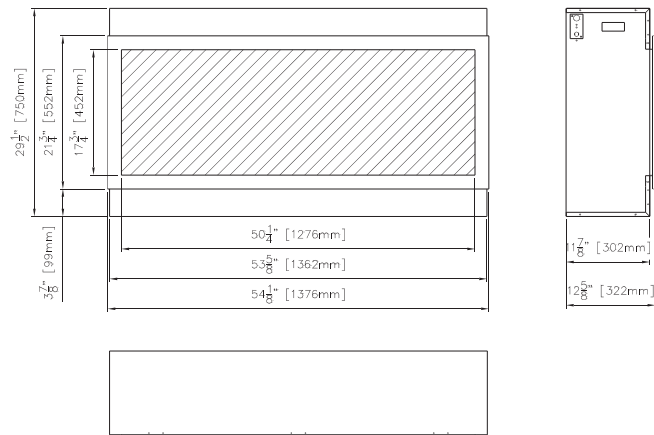

102755-XT

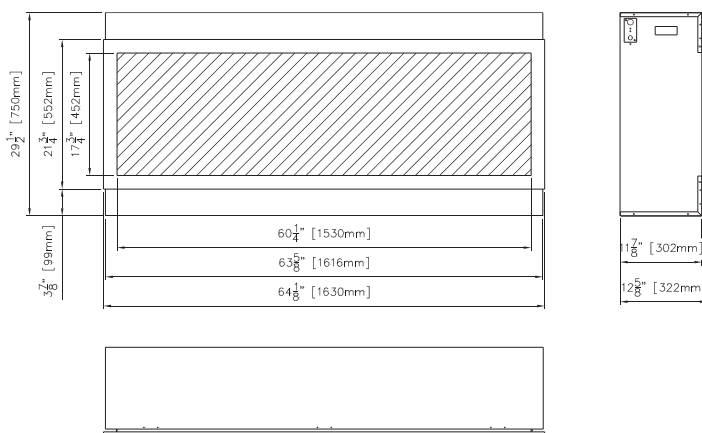

102765-XT



102755-XT electric fireplace



# BAY SERIES



30-BAY-SLIM electric fireplace

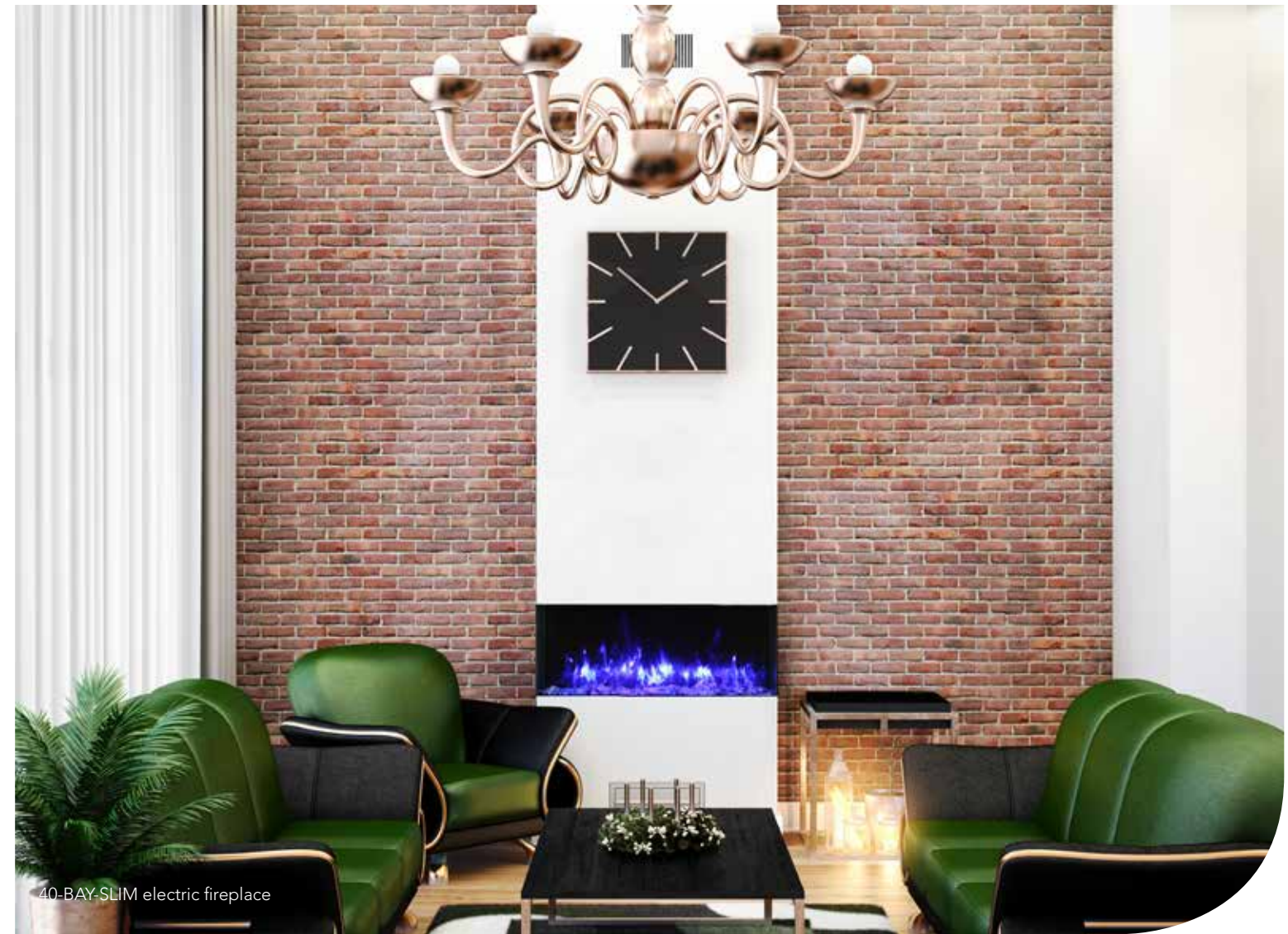









40-BAY-SLIM electric fireplace



With a depth of less than 4", the Bay series of electric fireplaces is designed to be installed into a 2" x 4" wall. Available in five sizes, you'll find a unit that is perfect for any space in your home, business or commercial space. The Bay is perfectly suited to installations where wall depth is at a premium.

The Bay model comes standard with a 10 Piece Birch Style Log Set, two colors of real fireglass and two colors of vermiculite.

### KEY FEATURES: Bay

-  State-of-the-art FIRE & ICE® flame set, with a click of the remote, change the flame from traditional colors such as yellow and orange to more contemporary colors like blue, purple, rose and violet.
-  Ambient canopy lighting in 13 colors illuminates media like never before
-  Comes with a 10 piece log set and charcoal grey fire glass, vermiculite, black fire glass plus a remote.
-  2 Stage Heater  
Flame operates with or without heat  
Remote control for flame and heater
-  Very thin – only 4" in depth
-  Approved for Indoor and Outdoor Use
-  Thermostat hard-wire ready  
Electrical hard-wire ready
-  Can produce up to 4800 BTU of heat, enough to heat up to 500 sq feet

	30-BAY-SLIM	40-BAY-SLIM	50-BAY-SLIM	60-BAY-SLIM	72-BAY-SLIM
Volts	120 AC 60 Hz	120 AC 60 Hz	120 AC 60 Hz	120 AC 60 Hz	120 AC 60 Hz
Watts	1500 max	1500 max	1500 max	1500 max	1500 max
No Heater	25 watts	25 watts	25 watts	25 watts	25 watts
Motor Heater	19 watts	19 watts	19 watts	19 watts	19 watts
Appliance Width Appliance Height	33 1/4" 26 5/8"	43 1/4" 26 5/8"	53 1/4" 26 5/8"	63 1/4" 26 5/8"	75 1/4" 26 5/8"
Appliance Depth	4"	4"	4"	4"	4"
Gross Weight	85 lbs.	104 lbs.	121 lbs.	140 lbs.	167 lbs.
Plug Location	Left Side	Left Side	Left Side	Left Side	Left Side
Cord Length	70-7/8"	70-7/8"	70-7/8"	70-7/8"	70-7/8"
Rough Wall Opening					
BTU	4800	4800	4800	4800	4800

### IN THE BOX



\*Remote control may not be exactly as shown





50-BAY-SLIM electric fireplace



60-BAY-SLIM electric fireplace

**SLIM**

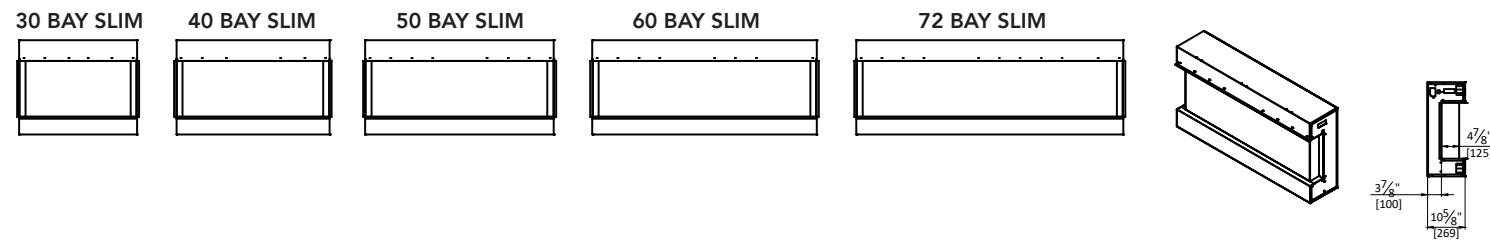

**FOUR INSTALLATION CONFIGURATIONS**

- All 3 sides of glass visible
- Left side visible
- Right visible
- Front only for an extra deep (14 1/4") fireplace

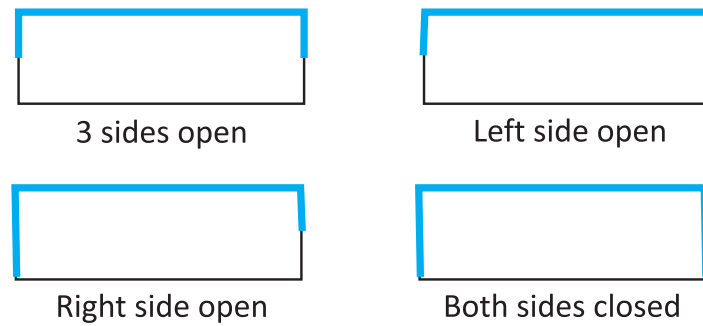

72-BAY-SLIM electric fireplace



WM



WM-74 electric fireplace

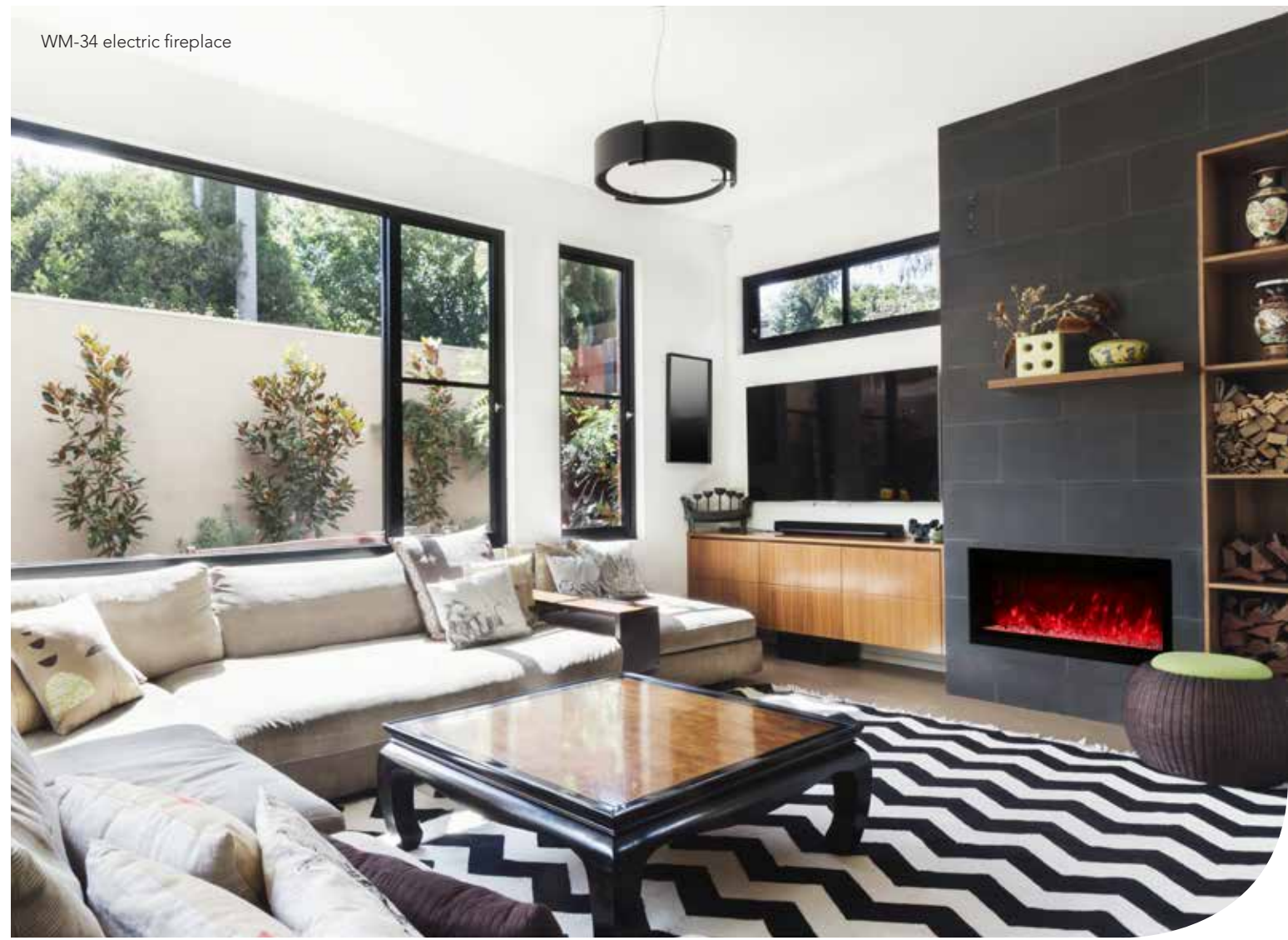

WM-34 electric fireplace



The WM series offers a choice of two flame patterns, Amantii's traditional diffused flame appearance and a new realistic flame style. The WM features the multi-color FIRE & ICE® flame presentation and boasts a true clean face display unencumbered by unsightly heat vents. Ambient canopy lighting illuminates decorative media adding another element of dimension. The slim design allows for versatile applications, inside or outside, including semi-flush mount within 2 x 4 wall and the standardized sizing allows for hassle free installation at any stage of your project.

**KEY FEATURES: WM**



**Install option**

Can be fully recessed  
Can be semi-flush mounted\* within a 2x4 wall. \*SYM-XS surround required



**Heater & Fan**

Flame operates with or without heat, perfect for zone heating



**Ambient Canopy Lighting**

Choose from 13 colors of light to illuminate decorative media from above



**Flame Styles**

Two flame style patterns - standard and more traditional - you choose!



**FIRE & ICE® Flame presentation**

Choose from combinations of yellow, orange, blue, violet & rose colored flames



**Touch Pad**

For convenient control of features with temperature display

	WM-34	WM-42	WM-50	WM-60	WM-74	WM-88	WB-100
Volts	120	120	120	120	120	120	120
Amps	13	13	13	13	13	13	13
Watts	1200 max	1200 max	1200 max	1200 max	1200 max	1200 max	1200 max
Heater On	1200 max 600 watts low	1200 max 600 watts low	1200 max 600 watts low	1200 max 600 watts low	1200 max 600 watts low	1200 max 600 watts low	1200 max 600 watts low
Heater Off	22 watts	22 watts	22 watts	22 watts	22 watts	22 watts	22 watts
Rotor Motor	1 at 5 watts	1 at 5 watts	1 at 5 watts	1 at 5 watts	1 at 5 watts	1 at 5 watts	1 at 5 watts
Appliance Width	32-3/8"	42-1/4"	50-1/4"	60-1/4"	72-3/8"	88-1/4"	100-1/4"
Appliance Height	15-5/8"	15-5/8"	15-5/8"	15-5/8"	15-5/8"	15-5/8"	15-5/8"
Appliance Depth	5-1/2"	5-1/2"	5-1/2"	5-1/2"	5-1/2"	5-1/2"	5-1/2"
BTU	4500	4500	4500	4500	4500	4500	4500

Hidden venting and no grills. The heater is located at the top of the unit allowing heat to cascade down in front of the glass.

**IN THE BOX**

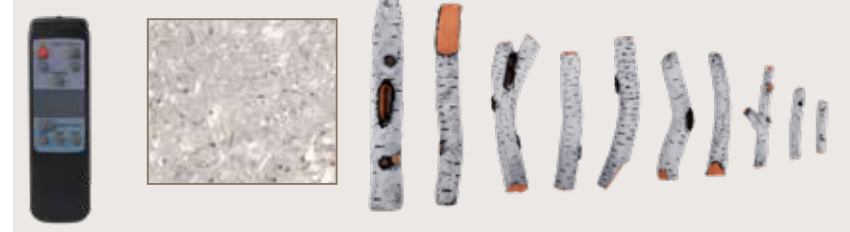

**OPTIONAL SURROUNDS**

For WM fireplaces only.  
See page 16 for more details.

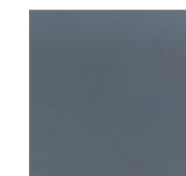

Dark Grey



Bronze





WM-42 electric fireplace



WM-50 electric fireplace

## WM SURROUND OPTIONS

### OPTIONAL SURROUNDS

Add a designer touch to your space with a beautifully finished Dark Grey or Bronze colored surround. These decorative surrounds will compliment all WM fireplaces: 34", 42", 50", 60", 74", 88", 100". The surrounds will arrive in a separate package.

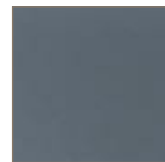

Dark Grey

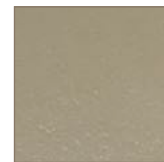

Bronze

### FOR SEMI-FLUSH MOUNT INSTALLATION

For rooms where space may be at a premium, WM models can also be partially recessed within a 2 x 4 wall. The unit will sit 2" outside of the wall with 4" of the unit mounted inside.

- This install option requires the Semi-Flush Mount Surround (SYM-XS) to finish the look of the fireplace.
- The Semi-Flush Mount Surround has a black finish and has a depth of 2 1/4"
- The Semi-Flush Mount Surround must be purchased separately. Ships in a separate box.
- **This application is only applicable to the WM models**

### CLEAN FACE NO UNSIGHTLY VENTING

Unlike models made by other manufacturers, WM-B models are unencumbered by unsightly venting. Venting and grills take away from the aesthetics of a fireplace and the WB-B series have some of the biggest glass viewing areas in the industry. You'll see more of what is important - a beautiful, warm and comforting flame display.

### HASSLE FREE INSTALLATION

The SYMMETRY has been made with standardized unit sizing. This means that the opening for the fireplace can be made at any stage of a build, the appliance can be easily installed and finished with the included surround at the end of a project. The surround beautifully completes the fireplace without the need for finicky or costly finishing.

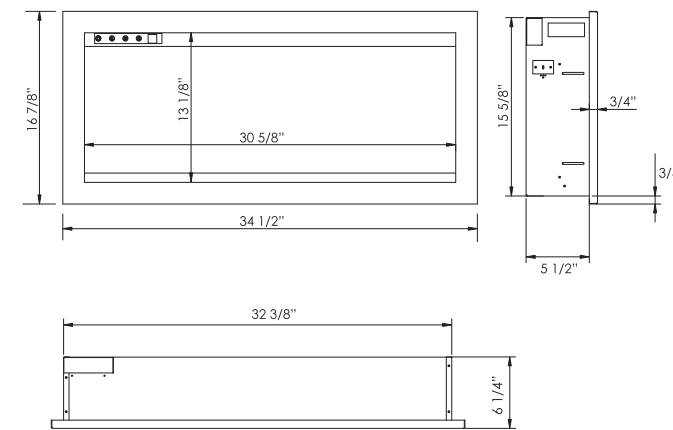

WM-34

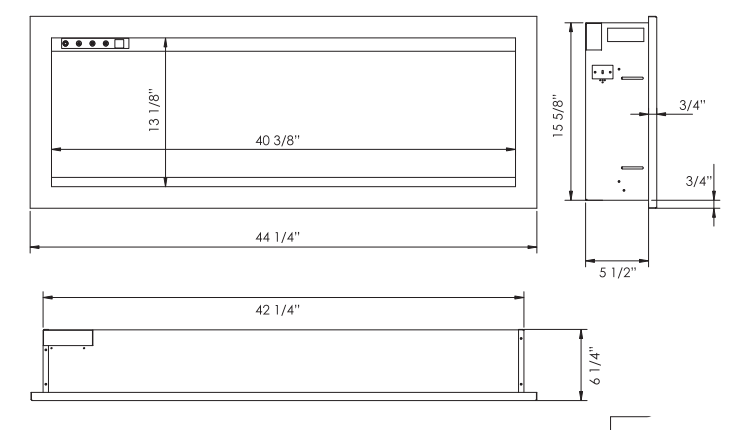

WM-42

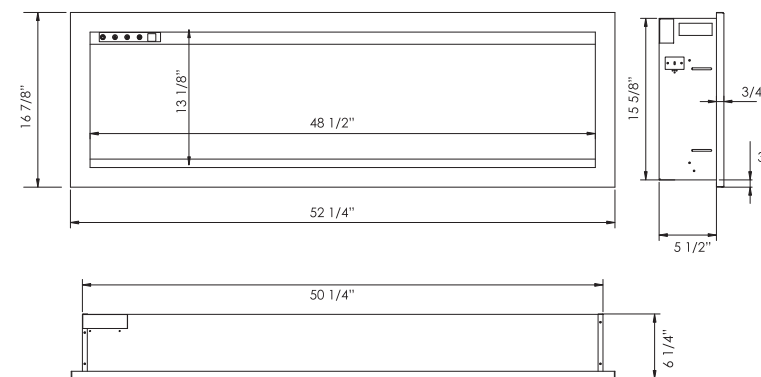

WM-50

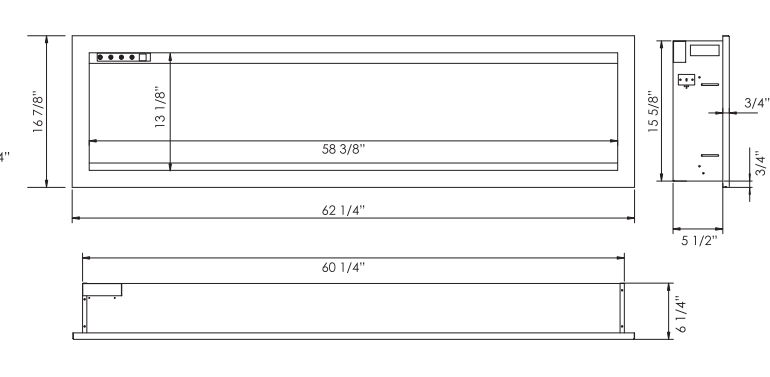

WM-60





WM-60 electric fireplace



WM-88 electric fireplace

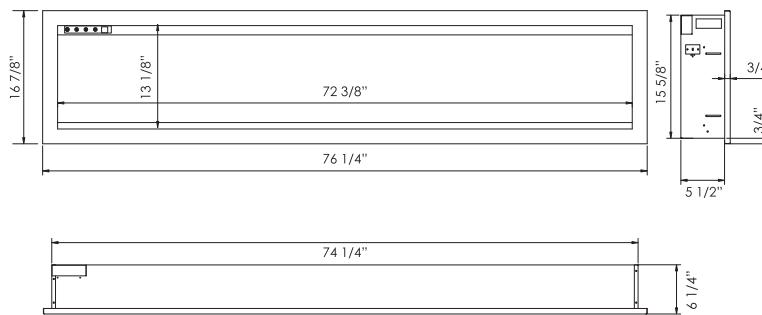

WM-74

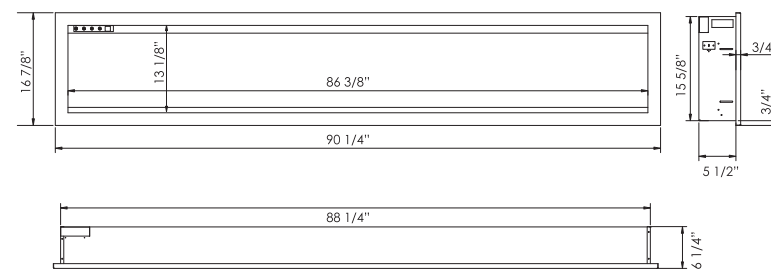

WM-88

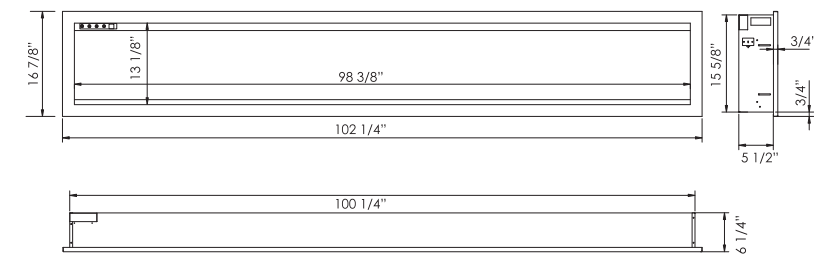

WM-100



WM-100 electric fireplace



# FIRE GLASS & MEDIA OPTIONS

Our decorative fire glass media is a beautiful addition to your electric fireplace. Turn your fireplace into an expressive work of art by simply adding our decorative fire glass media. Our fire glass adds a distinctly modern feel to your electric fireplace - mix colors and textures for a unique appearance.

Always wear protective gloves when handling fire glass media. One 5lb container of media will cover 1 square foot.



AMSF-GLASS-01



AMSF-GLASS-02



AMSF-GLASS-03



AMSF-GLASS-04



AMSF-GLASS-05



AMSF-GLASS-06



AMSF-GLASS-07



AMSF-GLASS-08



AMSF-GLASS-09



AMSF-GLASS-10



AMSF-GLASS-11



AMSF-GLASS-12



AMSF-GLASS-13

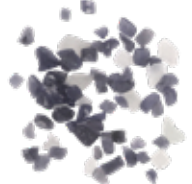

AMSF-GLASS-14

## DESIGNER MEDIA KITS

### DESIGN-MEDIA-DRIFT-15PCE



### DESIGN-MEDIA-RUSTIC-14PCE



### DESIGN-MEDIA-BIRCH-15PCE

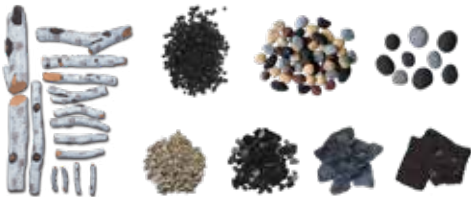

### DESIGN-MEDIA-LOG-6PCE



## DECORATIVE MEDIA OPTIONS



FI-105-Diamond



FI-106-Diamond



FI-107-Diamond

Images are not to scale, please visit your local dealer to view the actual accessories. Variations in the color and shade are inherent in all printing processes, the actual colors may vary slightly from those shown in this brochure. Please visit your local dealer to view a sample.

**Note: Log sets and Designer Media Kits will fit in all sizes of the following models - Deep and Extra Tall ONLY**

For Designer Media Kits, depending on the size of the model, not all media included may be required to be used.

April, 2021

Distributed By:

Visit our online showrooms at:

**Remii**

www.remii.com

Phone: 800.986.1864

We reserve the right to update products, specifications and dimensions are subject to change. Please refer to the product manual to verify measurements and clearance requirements. All local building codes must be followed.