



**BROMIC**<sup>®</sup>  
HEATING

TUNGSTEN  
**SMART-HEAT™ GAS**

---



# TUNGSTEN SMART-HEAT™ GAS

Our Tungsten Smart-Heat™ Gas heater has a durable, soft flowing curved fascia and engineered body, which produces formidable heat to create a truly comfortable outdoor space. Its easy pivot arm allows for greater positioning and directional heat control. This heater also has a range of accessories available to provide versatility in mounting & controller options.

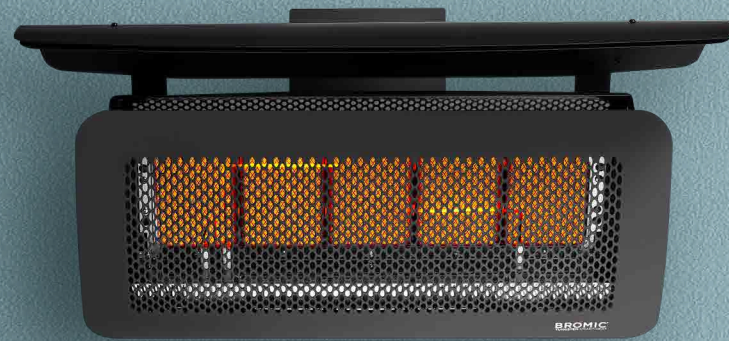

500 SERIES



300 SERIES

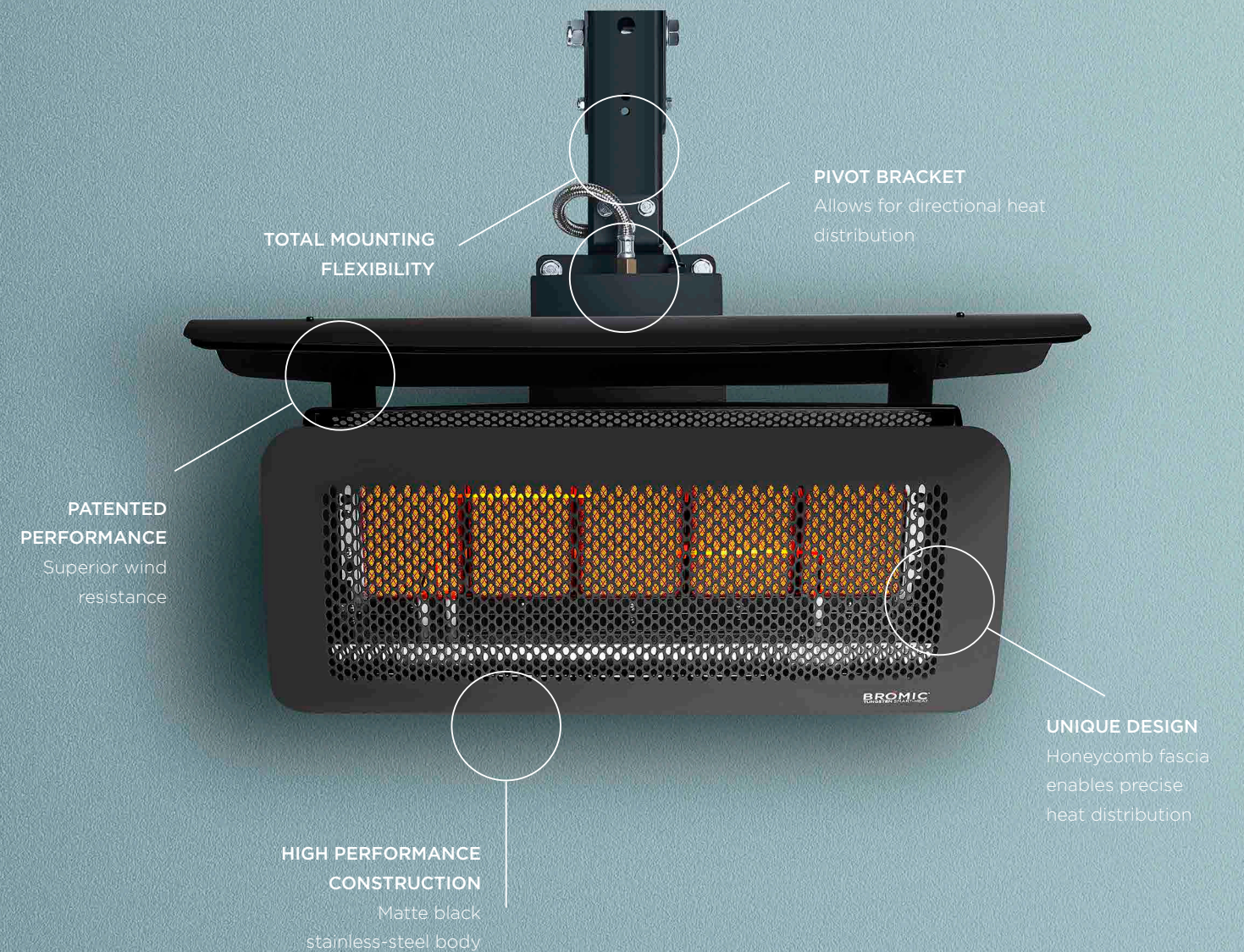





EXTEND YOUR COMFORT OUTDOORS  
WITH THE SUPERIOR HEAT AND  
AWARD-WINNING DESIGN OF OUR  
SMART-HEAT™ OUTDOOR HEATERS.



# TUNGSTEN SMART-HEAT™ GAS

MODEL NUMBER	300 SERIES	500 SERIES
PRODUCT CODE	BH0210002-1   BH0210001-1	BH0210004-1   BH0210003-1
FUEL TYPE	LPG   NG	LPG   NG
COLOR	BLACK	BLACK
HEAT AREA	160FT <sup>2</sup>	215FT <sup>2</sup>
ELECTRICAL CONNECTION	110V/2A	110V/2A
MINIMUM FLOOR CLEARANCE	96"	96"
OUTPUT	26,000 BTU	43,000 BTU

## MOUNTING OPTIONS

CEILING MOUNT	✓	✓
WALL MOUNT	✓	✓
RECESSED   FLUSH MOUNT	-	-
CEILING POLE MOUNT	✓	✓
FREESTANDING	-	-

## CONTROL OPTIONS

ON   OFF	✓	✓
ON   OFF PRODUCT CODE	BH3130010-1	BH3130010-1
DIMMER	-	-
MASTER REMOTE	-	-

Measurements displayed within this catalog are minimum requirements for installation. Bromic takes no responsibility for incorrect or non-compliant installations. All measurements in this catalog are displayed in inches.

## PRODUCT MEASUREMENTS

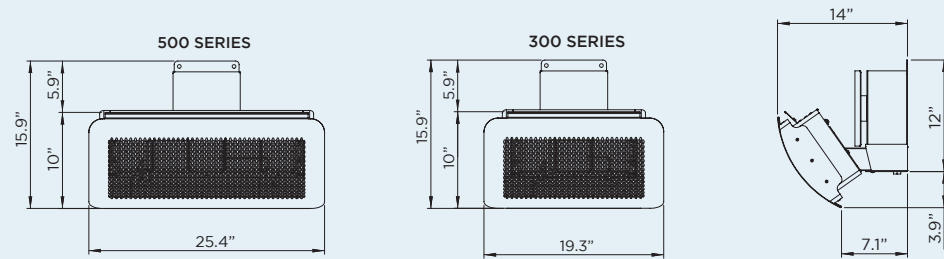

## PRODUCT MEASUREMENTS WITH HEAT DEFLECTOR

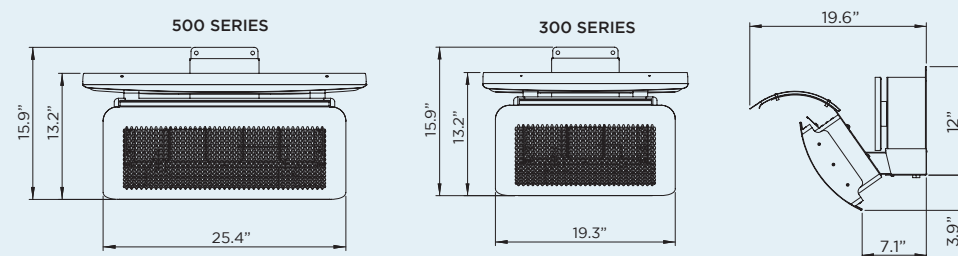

## CEILING & WALL MOUNT CLEARANCE

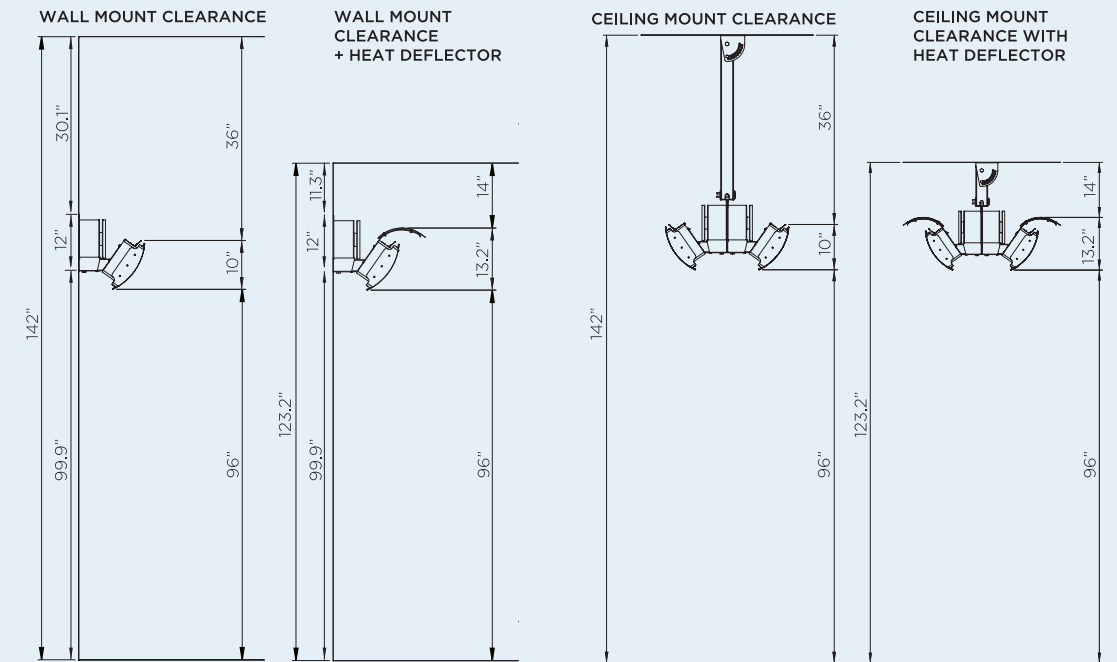

## WALL BRACKET

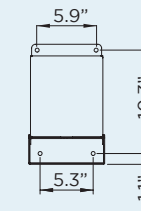

## HEAT AREA

500 SERIES

300 SERIES

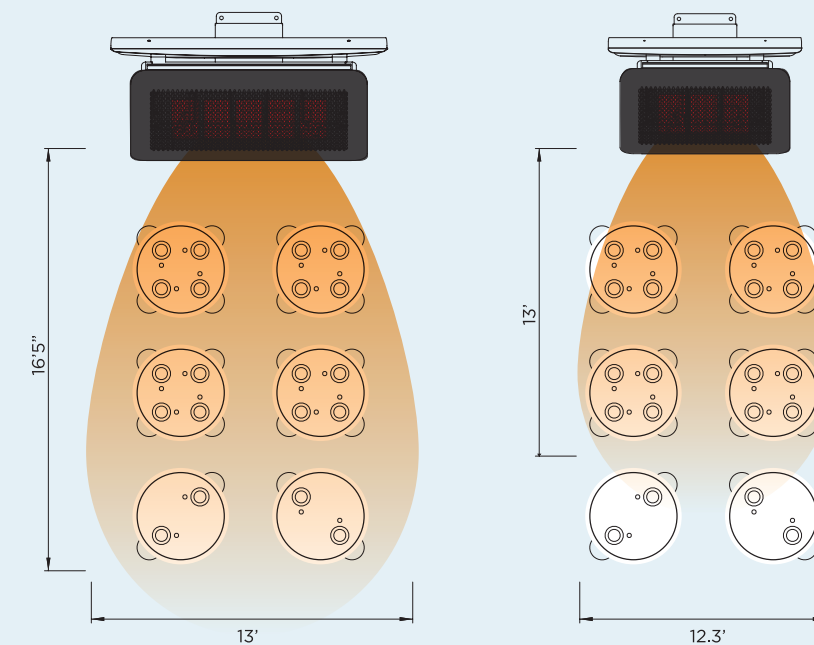

HEATING APPROXIMATELY 215FT<sup>2</sup>  
43,000 BTU HEATING POWER

HEATING APPROXIMATELY 160FT<sup>2</sup>  
26,000 BTU HEATING POWER

\*HEAT AREA DEPENDENT ON AMBIENT TEMPERATURE AND WIND. OPTIMUM CONDITIONS EXPERIENCED AT APPROX 60°F AND IN A LOW WIND COVERED ENVIRONMENT.