

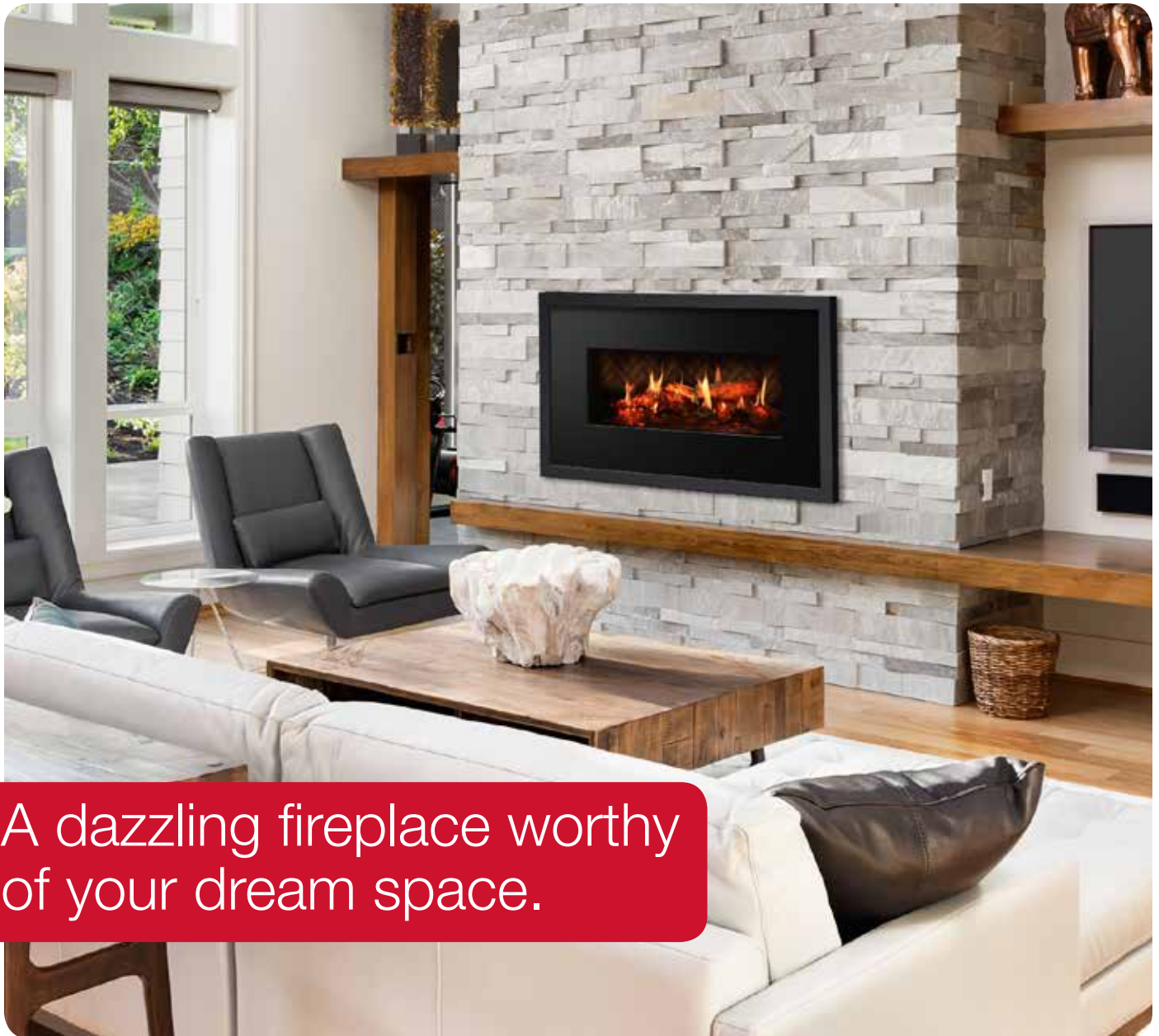

Opti-V™ Solo

VF2927L



A dazzling fireplace worthy of your dream space.

Opti-V™ Solo uses unprecedented technology to render flames and sparks for a virtual fireplace experience like no other. The unique design combines ultra realistic flickering flames with three dimensional LED logs that sporadically spark and crackle! The perfect blend of magic and realism - Opti-V™ is the most unbelievable flame effect yet.













## Opti-V™ Solo

## VF2927L



### Features

-  **Opti-V™ Flame Effect**  
High definition video and a three-dimensional illusion creates dazzling flames that flicker between the logs.
-  **Heat-free Operation**  
Designed with the sole purpose of providing a stunning visual flame feature.
-  **Crackling Sound Effects**  
Enjoy a more complete sensory experience with the sound of natural wood fire.
-  **Direct-wired**  
Designed to be direct-wired to a 120/240V circuit for a seamless look.
-  **All-season Flames**  
Enjoy the unique charm of a fireplace 365 days a year using the flames without the heat.
-  **Sight and Sound Remote**  
Control the flames and crackling sound effects at the touch of a button.
-  **Frame, Wire and Finish**  
Basic installation requires fewer tradespeople, no gas lines, venting or chimney.
-  **Ultra-energy Efficient**  
Uses less than 100 watts for incredibly low-cost operation.
-  **Zero emissions**  
The most sustainable fireplace option; with no emissions.
-  **Reduces Liability**  
Ideal for public spaces in commercial installations; meets the strictest building codes.
-  **Cool-touch Glass**  
Glass remains cool making it safe for children and pets in any location.

### Accessories



OT1957-BLACK - Trim Kit  
41-1/8 x 23-5/8 x 1-7/8 (104.5 cm x 60.0 cm x 4.8 cm)

| Model #      | Description                     | Lbs / Kg    | UPC           | Wty. <sup>1</sup> | Carton Dimensions (WxHxD) |                     | Cube            |                |
|--------------|---------------------------------|-------------|---------------|-------------------|---------------------------|---------------------|-----------------|----------------|
|              |                                 |             |               |                   | Inches                    | cm                  | ft <sup>3</sup> | m <sup>3</sup> |
| VF2927L      | Opti-V™ Solo Built-in Fireplace | 63 / 28.6   | 781052 092877 | 2 yr.             | 33-7/8 x 17-3/4 x 22-1/8  | 86.0 x 45.0 x 56.0  | 7.7             | 0.2            |
| OT1957-BLACK | Opti-V™ Black Trim              | 38.7 / 17.6 | 781052 126282 | 1 yr.             | 44-7/8 x 27-5/8 x 5-1/2   | 114.0 x 70.0 x 14.0 | 3.9             | 0.11           |

Specifications, finishes and dimensions are subject to change. <sup>1</sup>Limited warranty. ©2018 Glen Dimplex Americas

SE-020-R08-122018

## Opti-V™ Solo

VF2927L

### Product Dimensions:

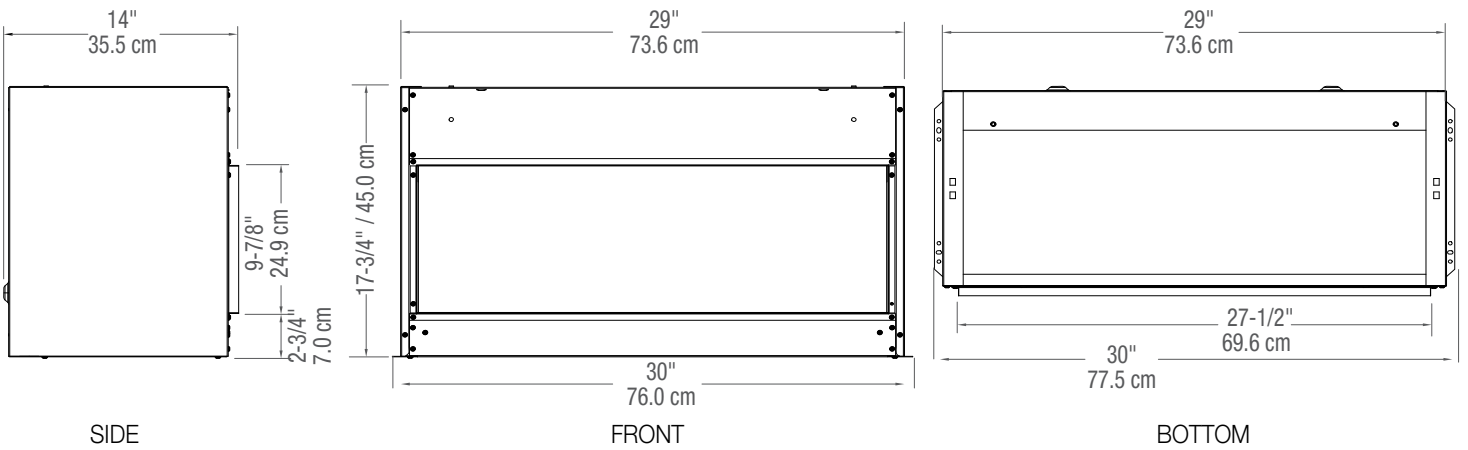

### Framing Dimensions:

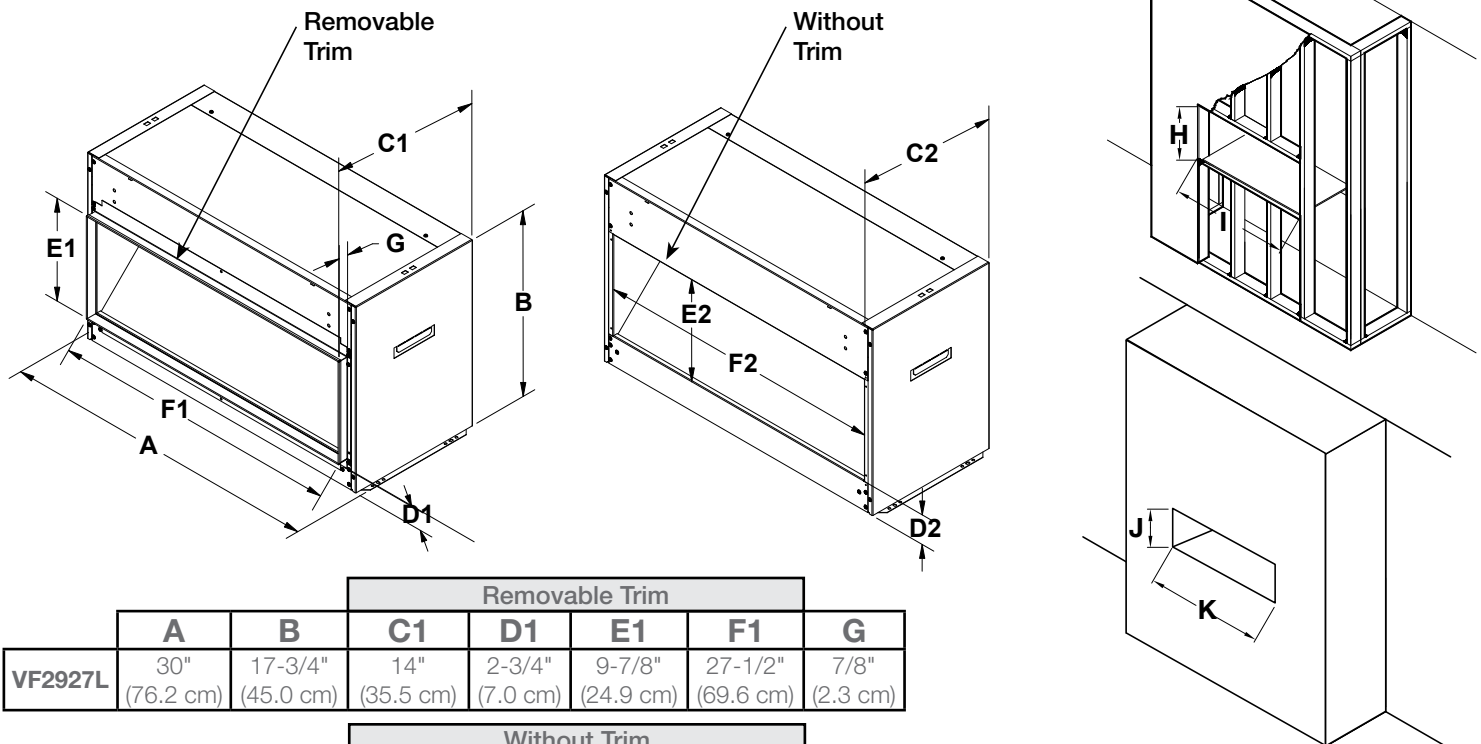

|         | Removable Trim   |                      |                  |                    |                     |                      |                  |
|---------|------------------|----------------------|------------------|--------------------|---------------------|----------------------|------------------|
|         | A                | B                    | C1               | D1                 | E1                  | F1                   | G                |
| VF2927L | 30"<br>(76.2 cm) | 17-3/4"<br>(45.0 cm) | 14"<br>(35.5 cm) | 2-3/4"<br>(7.0 cm) | 9-7/8"<br>(24.9 cm) | 27-1/2"<br>(69.6 cm) | 7/8"<br>(2.3 cm) |

| Without Trim     |                |                     |                  |                      |                      |                     |                  |
|------------------|----------------|---------------------|------------------|----------------------|----------------------|---------------------|------------------|
| C2               | D2             | E2                  | F2               | H                    | I                    | J                   | K                |
| 13"<br>(33.0 cm) | 3"<br>(7.5 cm) | 9-1/2"<br>(24.0 cm) | 27"<br>(68.4 cm) | 18-5/8"<br>(47.4 cm) | 30-1/2"<br>(77.5 cm) | 9-1/2"<br>(24.0 cm) | 27"<br>(69.0 cm) |