

SPECTRUM SLIMLINE WALL MOUNT/RECESSED ELECTRIC FIREPLACE

Model# : ■ SPS-50B ■ SPS-60B ■ SPS-74B ■ SPS-100B

OWNER'S MANUAL

MODERN FLAMES

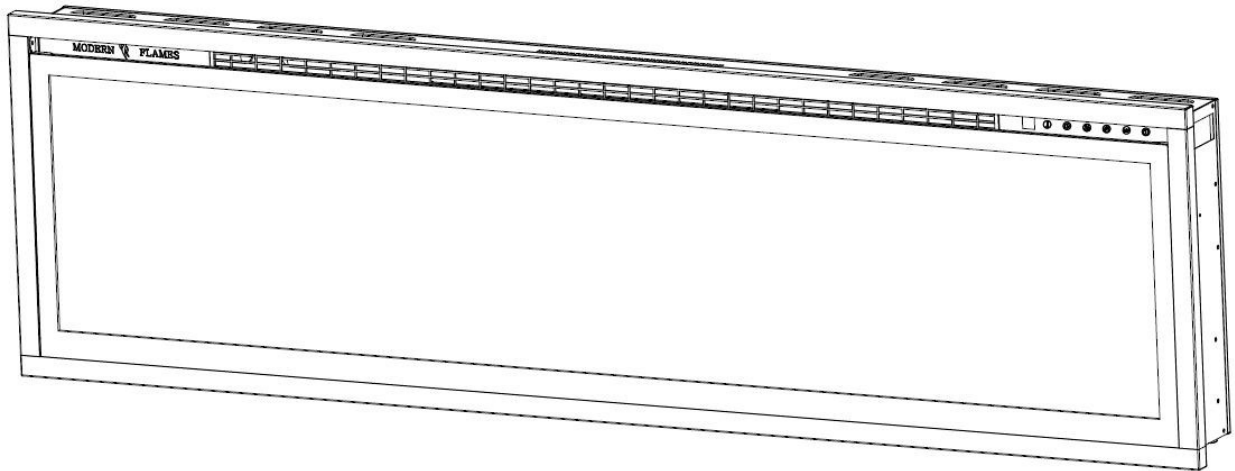

AC 120V 60Hz 1465W (5000BTUs)

WARNING

Read and understand this entire owner's manual, including **all safety information**, before plugging in or **using** this product. Failure to do so could result in **fire, electric shock, or serious personal injury**.

CAUTION

Keep this owner's manual for future reference. If you sell or give this product away, **make sure this manual accompanies this product**.

AFFIX SERIAL NUMBER LABEL HERE
FOR FUTURE REFERENCE



IMPORTANT SAFETY INFORMATION!

WARNING

- Read all instructions before installing or using this heater.
- **Use a dedicated 15 Amp (or higher) breaker.**
- This heater is **hot when in use**. To avoid burns, **DO NOT** let bare skin touch **hot** surfaces. If provided, use handles when moving this heater. Keep **combustible materials**, such as furniture, pillows, bedding, papers, clothes, and curtains at least **3 feet (0.9m)** from the **front of the heater**, and **keep them away from the sides and rear**.
- **Extreme caution** is necessary when any heater is used by or near **children** or **invalids** and whenever the heater is left **operating and unattended**.
- **Do not operate** any heater after it malfunctions. **Disconnect power** at service panel and have heater inspected by a reputable electrician before reusing.
- **Do not use outdoors.**
- To disconnect heater, turn controls to off, and turn off power to heater circuit at main disconnect panel (or operate internal disconnect switch if provided).
- **Do not insert** or allow foreign objects to enter any ventilation or exhaust opening as this may cause an electric shock, fire, or damage the heater.
- To prevent a possible fire, **do not block** air intakes or exhaust in any manner.
- A heater has hot arcing or sparking parts inside. **Do not use** in areas where gasoline, paint, flammable vapors, or liquids are used or stored.
- **Use this heater only as described in this manual. Any other use not recommended by the manufacturer may cause fire, electric shock, or injury to persons.**
- This heater may include an audible or visual alarm to warn that parts of the heater are getting excessively hot. If the alarm sounds (or illuminates), immediately turn the heater off and inspect for any objects on or adjacent to the heater that may have blocked the airflow or otherwise caused high temperatures to have occurred. **DO NOT OPERATE THE HEATER WITH THE ALARM SOUNDING (OR ILLUMINATING).**
- **ALWAYS plug heaters directly into a wall outlet/receptacle. NEVER use with an extension cord or relocatable power tap (outlet/power strip).**
- **NEVER** use this heater in **bathrooms, laundry rooms**, or any other location where the heater could fall into a **bathtub, pool, become damp, or come in contact with water**.
- **AVOID FIRE!** Regularly inspect all air vents to make sure they are free from dust, lint, or other blockage. **Unplug the unit** and clean with a **vacuum ONLY**. **DO NOT** rinse or get wet.
- **ALWAYS** mount to wall bracket before use. **DO NOT** set on the floor, or other surface, to use.
- **NEVER** use a wall mount bracket from another manufacturer.
- This product is **not intended** to be a **primary heat source**. It is for **supplemental heat only**.
- **INDOOR use only! NEVER** use this heater **outdoors!** Doing so may result in **electric shock!**
- **ALWAYS disconnect** this unit from the **power supply before** performing any assembly or

cleaning, or before relocating the electric fireplace.

- **NEVER** leave this heater unattended. **ALWAYS** unplug this heater when not in use.
- **ALWAYS** store this heater in a dry location. **NEVER** use the fireplace if it has become wet.
- **NEVER** plug this heater into an outlet that is **old, cracked**, or has any **loose wires or connections**. Plugging this heater into a faulty outlet could result in **electric arcing** within the outlet that could cause the **outlet to overheat or catch fire**.
- **ALWAYS** check your heater cord and plug connections with **each use**.
 - i) **MAKE SURE** the plug fits tight in the outlet. Faulty wall outlet connections or loose plugs can cause the outlet to overheat.
 - ii) **Heaters draw more current** than small appliances. **Overheating** may occur even if it has not occurred with the use of other appliances.
 - iii) During use **check frequently** to see if the **plug outlet or face plate is HOT**.
 - iv) If the outlet or face plate is **HOT, discontinue use immediately** and have a qualified electrician inspect and/or replace the faulty outlets.
- **SAVE THESE INSTRUCTIONS.**

Preparation











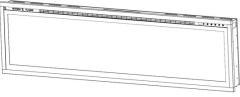

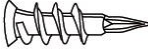

This product includes a **GLASS panel**. Always use **extreme caution** when handling **glass**. Failure to do so could result in **personal injury** or **property damage**.

Remove all parts and hardware from the carton and place them on a clean, soft, dry surface. Parts and assembly steps are grouped for wall-hanging or recessing use. Check the parts list to make sure nothing is missing. Dispose of packaging materials properly. Please recycle whenever possible.

You will need the following tools (not included): Phillips screwdriver, stud finder, level, tape measure, electric drill, 1/4" wood drill bit, hammer.

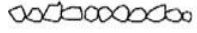
Parts and Hardware

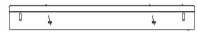
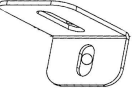
 A - Fireplace	 B - Screws (Long)	 C - Drywall anchors	 D - Screws (short)	 I - Cable Connector
 E - Ember bed strip	 F - Side Skirt (For wall mounting)	 G - Instruction manual	 H - Remote Control	 J - Cover Plate
 K - Wall Bracket (Fixed on back of firebox)	 L - Small glacier crystals	 M - Log set	 N - Metal bracket for wall recessed purpose	 O - "L" shape bracket

Specification and Dimension

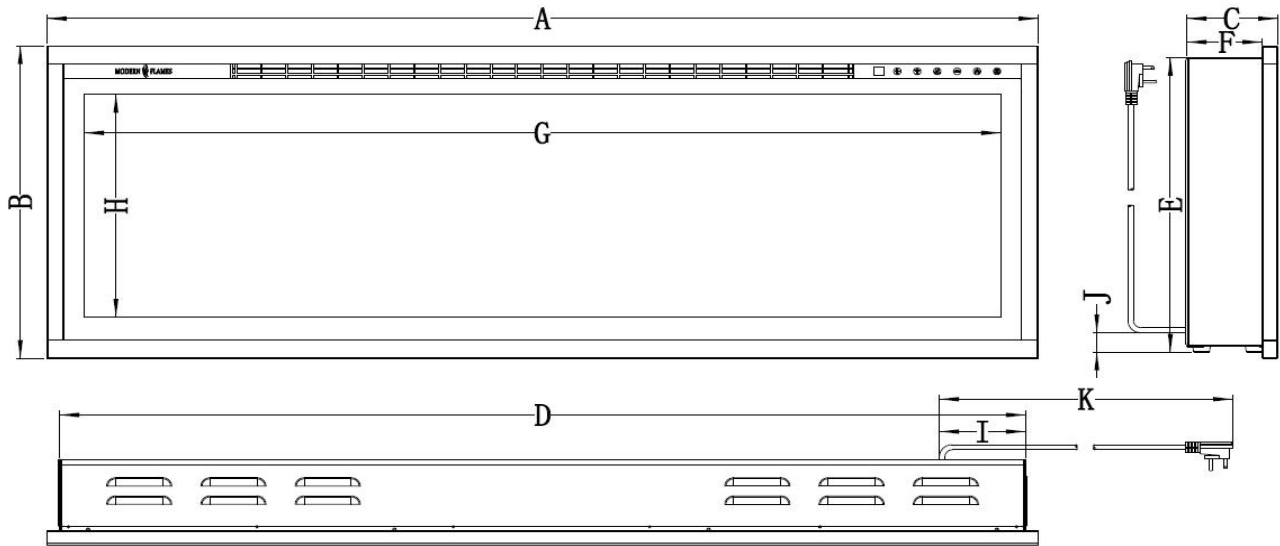

PRODUCT DIMENSIONS

Model Number	A	B	C	D	E	F	G	H	I	J	K
SPS-50B	49-3/4" (1264mm)	17" (430mm)	4-3/4" (121mm)	48-5/8" (1235mm)	16-1/8" (410mm)	4" (102mm)	46" (1168mm)	12" (305mm)	4-5/8" (118mm)	1" (25.4mm)	72" (1829mm)
SPS-60B	59-3/4" (1518mm)	17" (430mm)	4-3/4" (121mm)	58-5/8" (1489mm)	16-1/8" (410mm)	4" (102mm)	55-13/16" (1418mm)	12" (305mm)	4-5/8" (118mm)	1" (25.4mm)	72" (1829mm)
SPS-74B	73-3/4" (1873mm)	17" (430mm)	4-3/4" (121mm)	72-5/8" (1845mm)	16-1/8" (410mm)	4" (102mm)	69-3/4" (1772mm)	12" (305mm)	4-5/8" (118mm)	1" (25.4mm)	72" (1829mm)
SPS-100B	99-3/4" (2534mm)	17" (430mm)	4-3/4" (121mm)	98-5/8" (2505mm)	16-1/8" (410mm)	4" (102mm)	95-7/8" (2435mm)	12" (305mm)	4-5/8" (118mm)	1" (25.4mm)	72" (1829mm)

Installation and Assembly

Your appliance is a wall-mounted, recessed, and/or mantel installed appliance. Select a suitable location that is not susceptible to moisture and is away from drapes, furniture and high traffic areas.

NOTE: Follow all National and local electrical codes.

MINIMUM CLEARANCE TO COMBUSTIBLES

Measurements are taken from the glass front.			
Bottom	0"	Top	11.8" (300mm) to mantel
Sides	0"	Top	11.8" (300mm) to ceiling
Back	0"		

MINIMUM MANTEL CLEARANCES

WARNING

WHEN USING PAINT OR LACQUER TO FINISH THE MANTEL, THE PAINT OR LACQUER MUST BE HEAT RESISTANT TO PREVENT DISCOLOURATION.

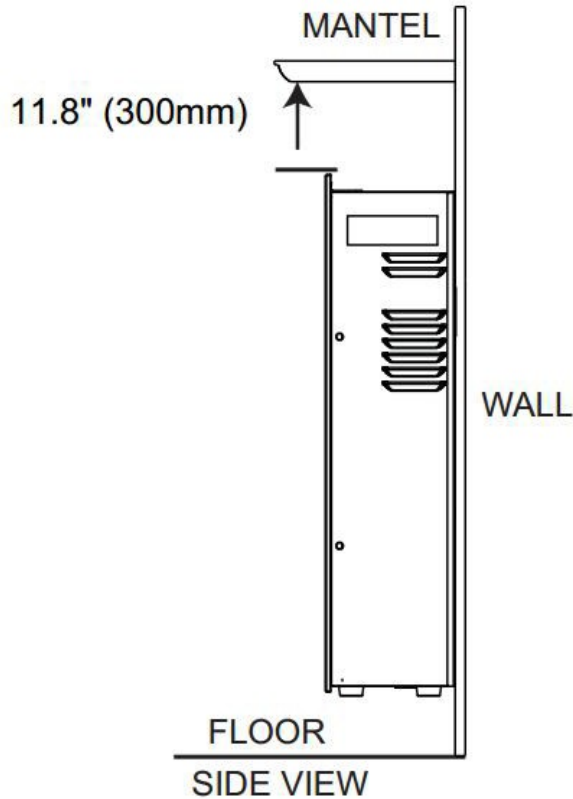

Front glass removal / installation

- A. With one hand on the front glass to prevent it from falling, remove the two screws (1 per side) from the side of the appliance (**Fig. 1-1**). Set the screws aside.
- B. Carefully lift the front glass up and away from the appliance (**Fig. 1-2**). Place it face down on a soft, non-abrasive surface.
- C. Reverse these steps to install the front glass.

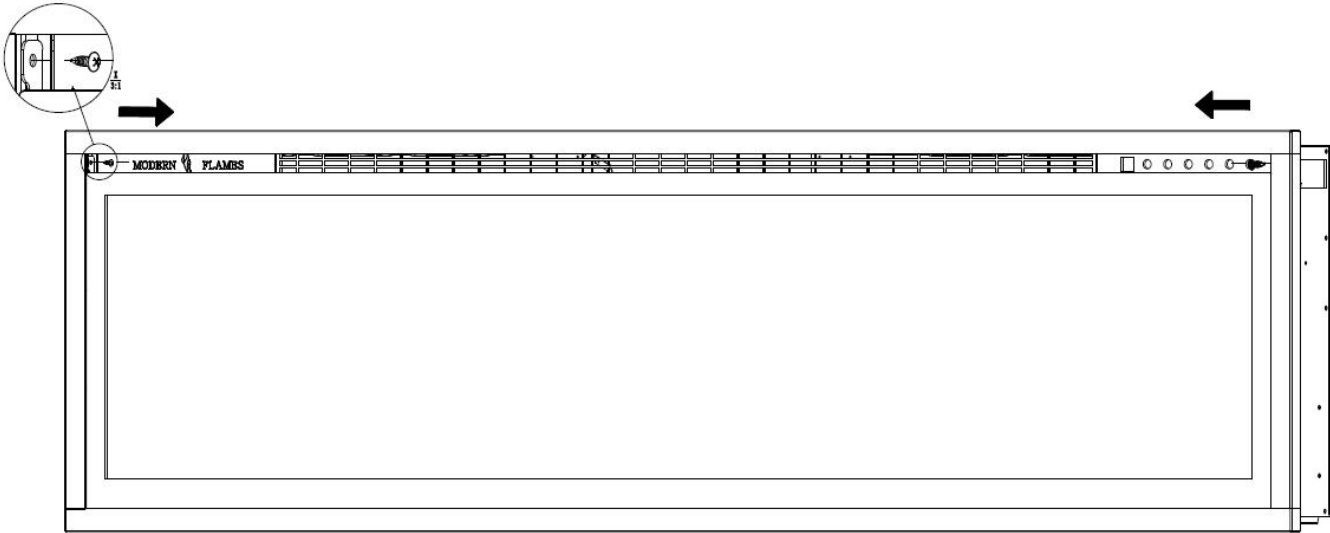

Fig. 1-1

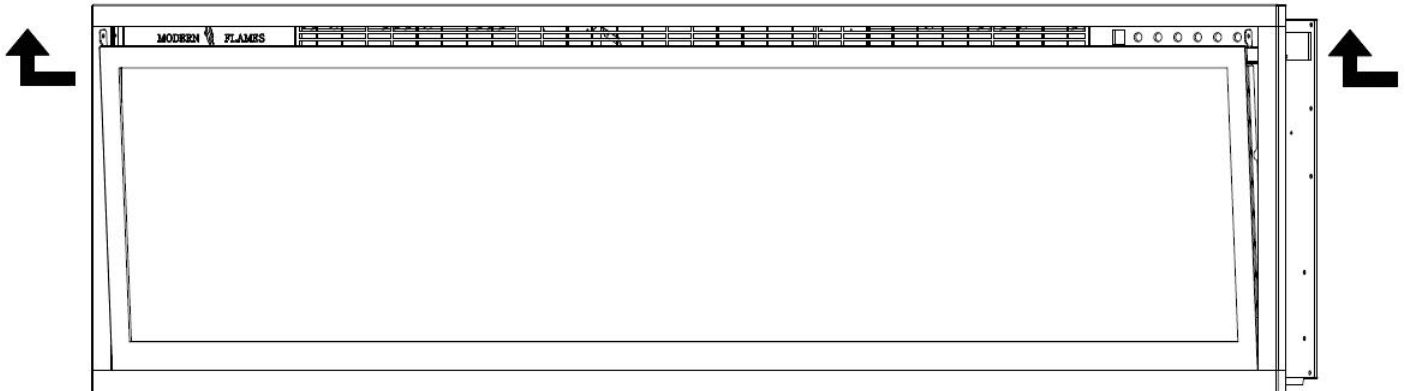
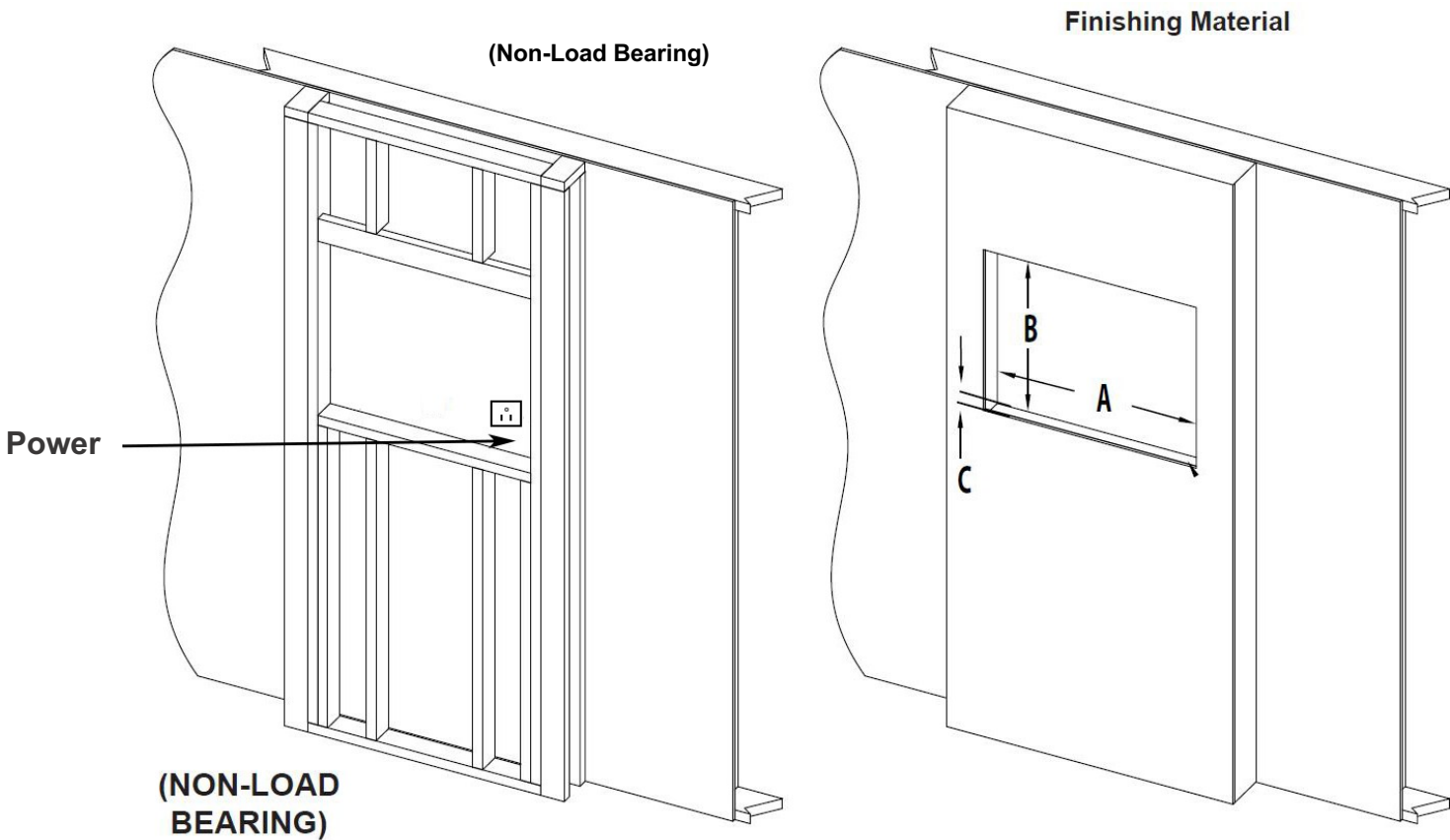

Fig. 1-2

Recessed pre-installation

Due to the many different materials used on different walls, it is highly recommended that you consult your local builder before you install this appliance on the wall.

- A. Select a location that is not prone to moisture and is located at least 36" (914mm) away from combustible materials such as curtain drapes, furniture, bedding, paper, etc.
- B. Measure the appliance and create a rough-in frame with electrical (see below "framing").
- C. Remove the front glass (see "front glass removal / installation" section).
- D. Hold the appliance up to ensure it will fit into the framing.



FINISHED OPENING DIMENSIONS			
Model Number	A	B	C
SPS-50B	48-7/8" (1242mm)	16-1/4" (413mm)	4" min. (102mm min.)
SPS-60B	58-7/8" (1496mm)	16-1/4" (413mm)	4" min. (102mm min.)
SPS-74B	72-7/8" (1851mm)	16-1/4" (413mm)	4" min. (102mm min.)
SPS-100B	98-7/8" (2512mm)	16-1/4" (413mm)	4" min. (102mm min.)

Fully recessed installation

- A. Remove power cord and complete hardwiring (see “hardwiring installation” section).
- B. Mark location for the screws according to the dimensions as below. **(Figure 2-1)**
- C. Fix the two metal brackets (N) (1per side), with 4 screws (B) (supplied) through wood stud. **(Figure 2-2)**

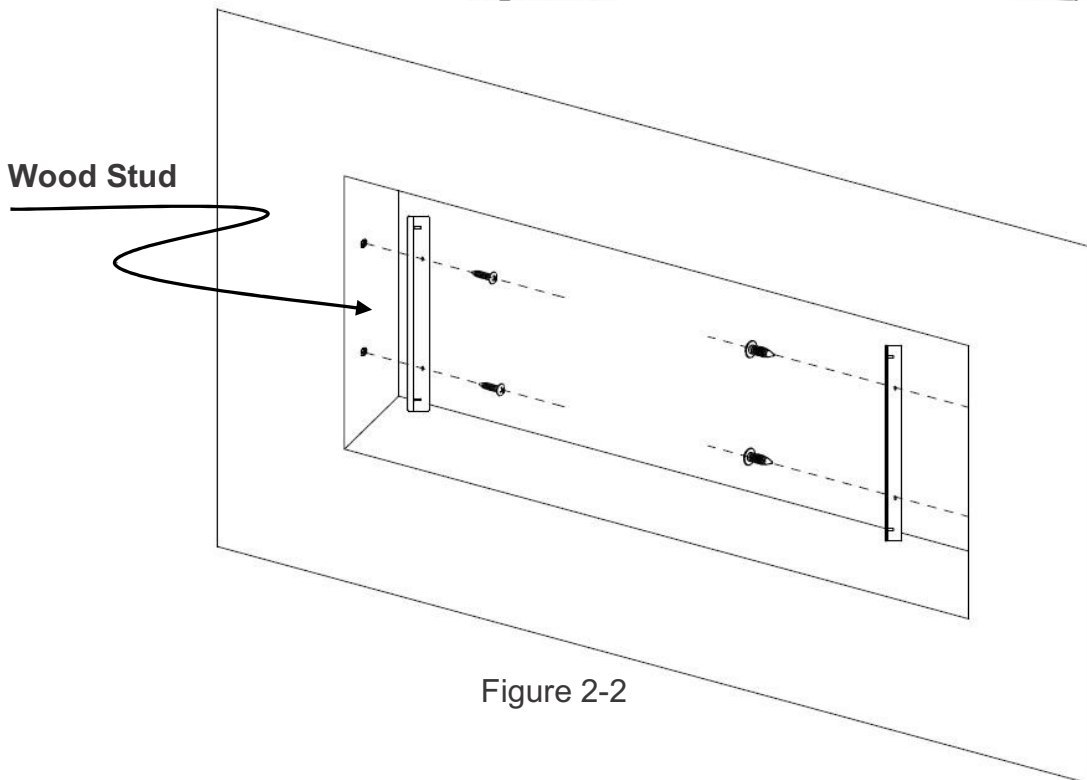
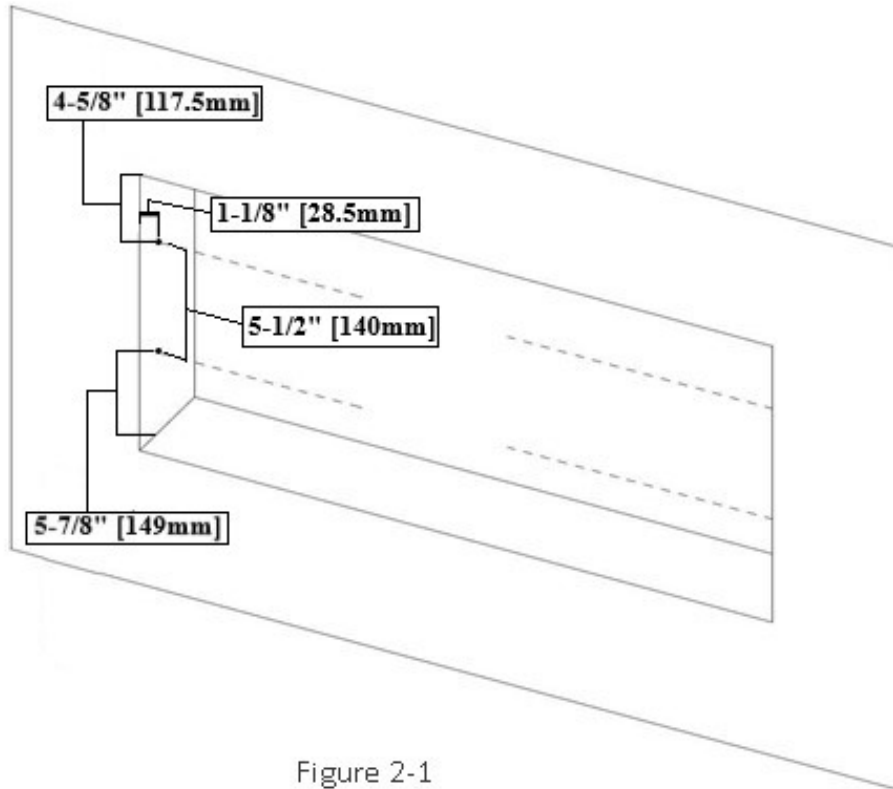

D. Remove the four screws (2 per side) from the side of the appliance and remove the brackets (Fig. 2-3). Set the screw/brackets aside.

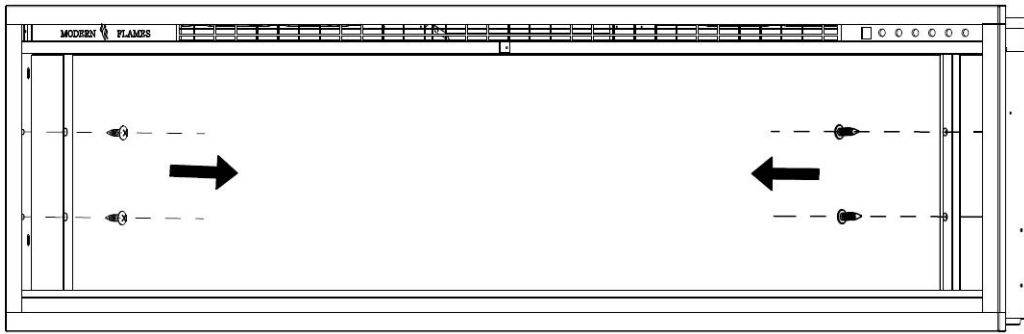

Figure 2-3

E. Insert the appliance into the rough-in frame (Fig. 2-4) and then secure it by installing 4 screws (supplied) into the slots on the insides (2 per side)(Fig. 2-5). Next reinstall the two brackets and 4 screws previously removed. (Fig. 2-6).

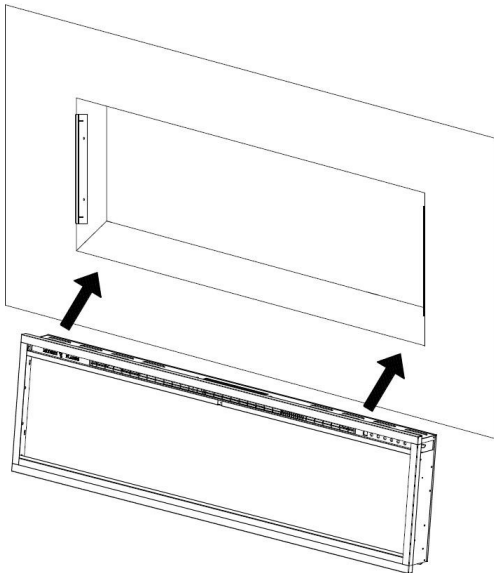

Figure 2-4

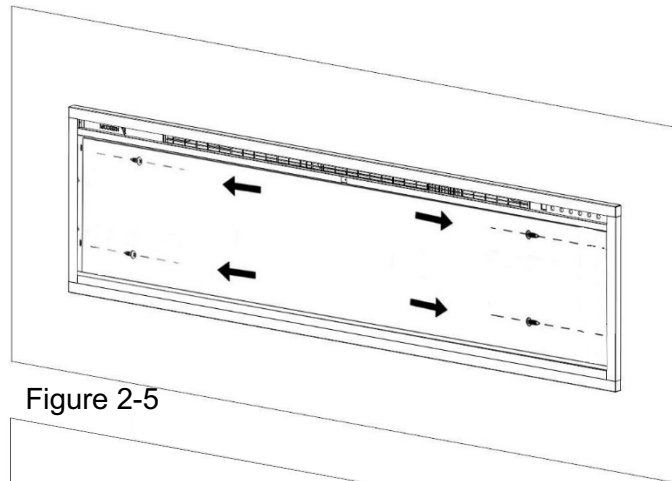

Figure 2-5

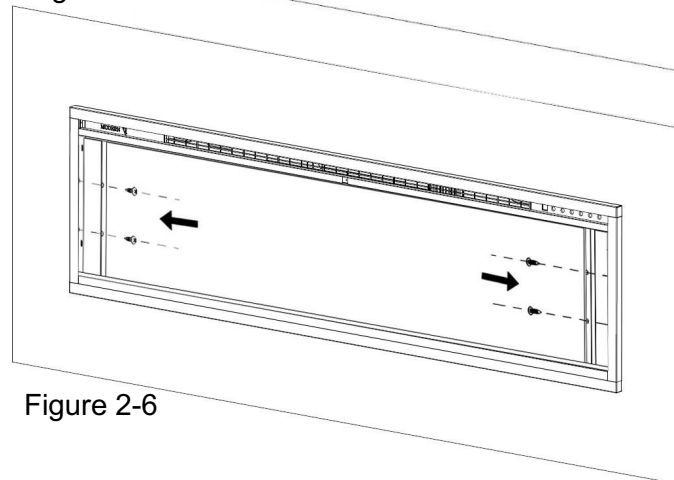
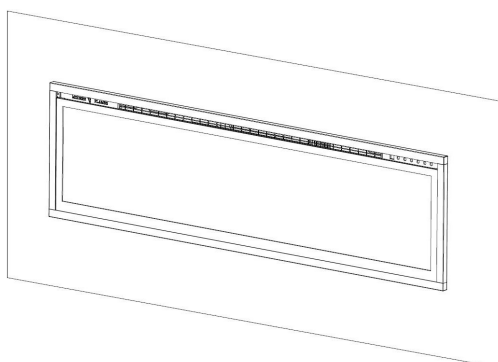

Figure 2-6

F. Install media (see “media installation” section). **You must complete this step before moving onto the next step.**

G. Re-install the front glass



Wall mounted installation

Due to the many different materials used on different walls, it is highly recommended that you consult your local builder before you install this appliance on the wall.

A. NOTE: A dedicated 15 Amp (or higher) breaker is required.

B. Select a location that is not prone to moisture and is located at least 36" (914mm) away from combustible materials such as curtain drapes, furniture, bedding, paper, etc.

C. Have two people hold the appliance against the wall to determine the final location.

D. Place unit face down on a soft, non-abrasive surface. Remove the wall bracket (K) from the back of the unit by removing the screws, refer to Figure 1.

E. Mark location, then mount the bracket(s) onto the wall using the supplied screws.

This bracket MUST have the hooks facing upward and be level. **NOTE: It is**

strongly recommended that the mounting bracket (K) be Screwed into the wall studs where possible. If the wall studs cannot be used, ensure

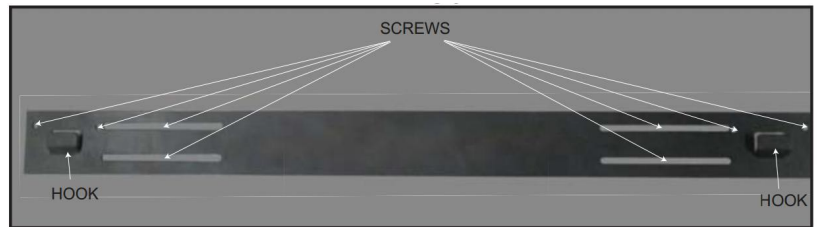

the supplied plastic anchors are used to affix the bracket to the wall and the bracket is adequately secured.

F. With the wall mounting bracket installed have two people lift the appliance up and insert the two hooks on the bracket into the two slots on the back of the appliance.

G. Check the appliance for stability ensuring that the bracket will not pull free from the wall.

H. Install the side skirt panels (F) to each side of firebox.

Size	A	B	C
50"	11-1/2" [292mm]	4-1/4" [108mm]	9-5/8" [244.5mm]
60"	8-1/4" [209.5mm]	4-1/4" [108mm]	9-5/8" [244.5mm]
74"	15-1/8" [384mm]	4-1/4" [108mm]	9-5/8" [244.5mm]

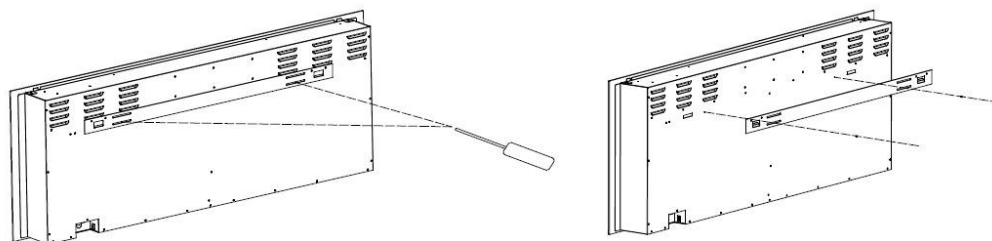
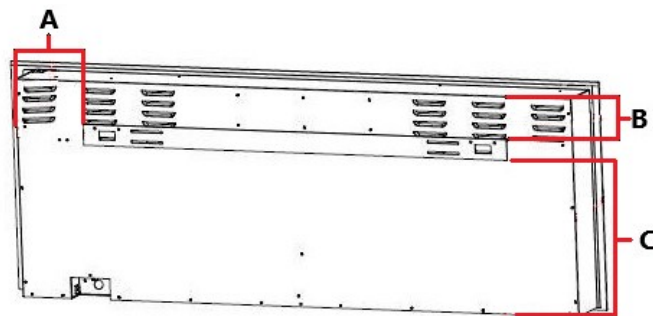

SPS-50/60/74B Wall Bracket Illustrated

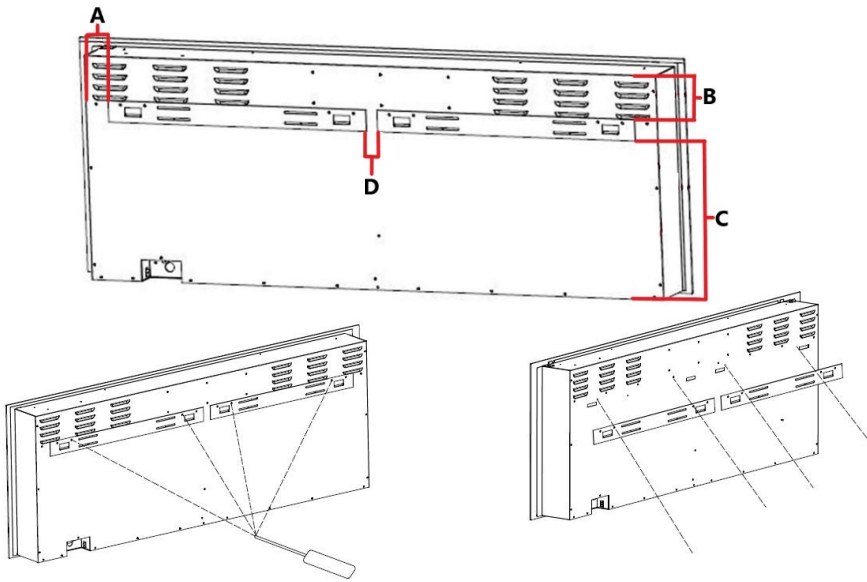

SPS-100B Wall Bracket Illustrated

Size	A	B	C	D
100"	5-3/8" [136.5mm]	4-1/4" [108mm]	9-5/8" [244.5mm]	3-1/4" [82.5mm]

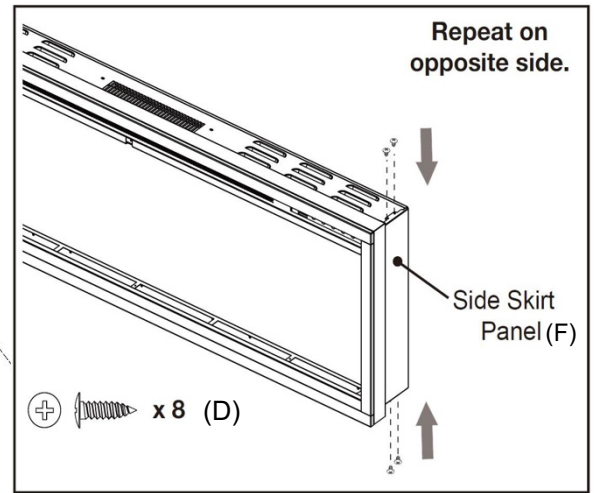

SPS-50/60/74/100B Side skirt illustration

“L” Shape bracket installation

A. Remove the silver screw at the bottom of the appliance. (Fig 3-1). Set the screw aside.

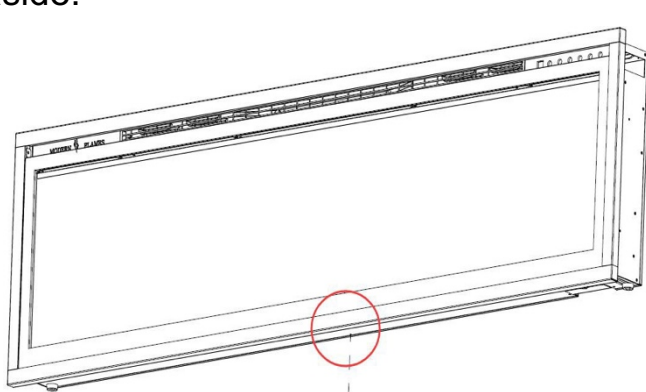

Fig 3-1

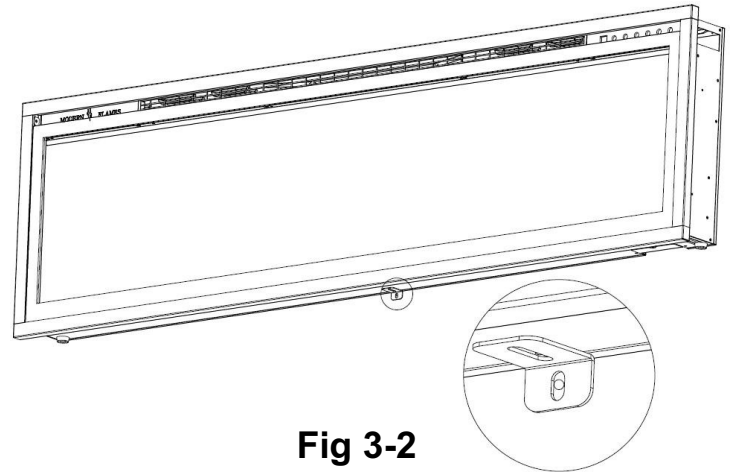

Fig 3-2

B. Using the screw previously removed, attached the L-bracket (O) (supplied) to the bottom of the fireplace box.(Fig 3-2)

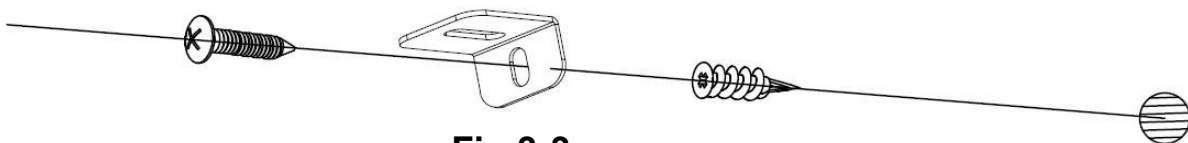

Fig 3-3

C. Install the plastic anchor (C) into the dry wall, then install the screw (B) (supplied) into the hole of the L-bracket into the wall anchor to secure the fireplace from coming off the hooks.(Fig 3-3)

Hard wiring installation

WARNING

TURN OFF THE APPLIANCE COMPLETELY AND LET COOL BEFORE SERVICING. ONLY A QUALIFIED SERVICE PERSON SHOULD SERVICE AND REPAIR THIS ELECTRIC APPLIANCE.

HARD WIRING CONNECTION

If it is necessary to hard wire this appliance, a qualified electrician must remove the cord connection, and wire the appliance directly to the household wiring. **NOTE: A dedicated 15 Amp (or higher) breaker is required.**

This appliance must be electrically connected and grounded in accordance with local codes if hard wired. In the absence of local codes, use the current CSA C22.1 CANADIAN ELECTRICAL CODE in Canada or the current ANSI/NFPA 70 NATIONAL ELECTRICAL CODE in the United States.

Fig. 1



Fig. 2



TURN OFF POWER FROM CIRCUIT BREAKER FIRST

- Remove the cover plate from the right side bottom of the appliance by removing the three screws, as shown above. (SEE FIG.1)
- Remove the wire nuts from the power cord. The power cord may be discarded. (SEE FIG.2)
- Take the new cover plate, supplied in the hardware bag and punch out the 7/8" (22.2mm) hole and install cable connector through into the junction box. Snap the cable connection clamp onto the supply wires.
- Using the wire nuts, connect the ground green wires (G), the common white wires (N) together, then the hot black wires (L), (SEE FIG.3)
- Re-install the cover plate using the three screws, as shown in FIG.1.

Fig. 3

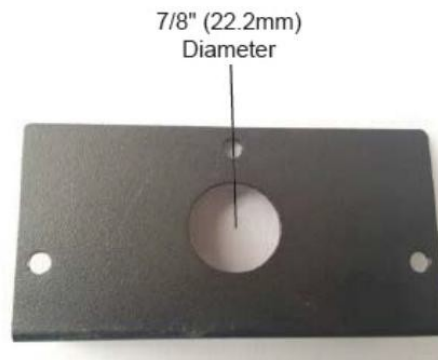
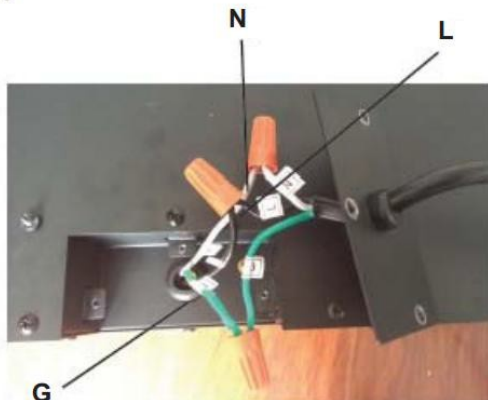

Cover plate (J)



Cable connector (I)

Driftwood Logs and Glacier Crystal installation

- A. Glass front must be removed and the appliance must be mounted in its final location before the driftwood logs (**M**) and glacier crystals (**L**) are installed.
- B. Place the ember bed strip (**E**) in position.
- C. Install logs (**M**) first, then add Glacier Crystals (**L**) around logs.
- D. Photo below shows recommended log placement but logs may be arranged to customer's liking.

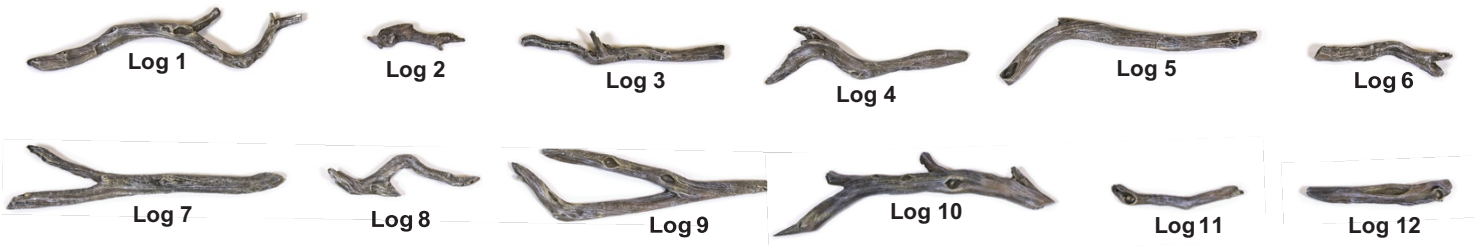
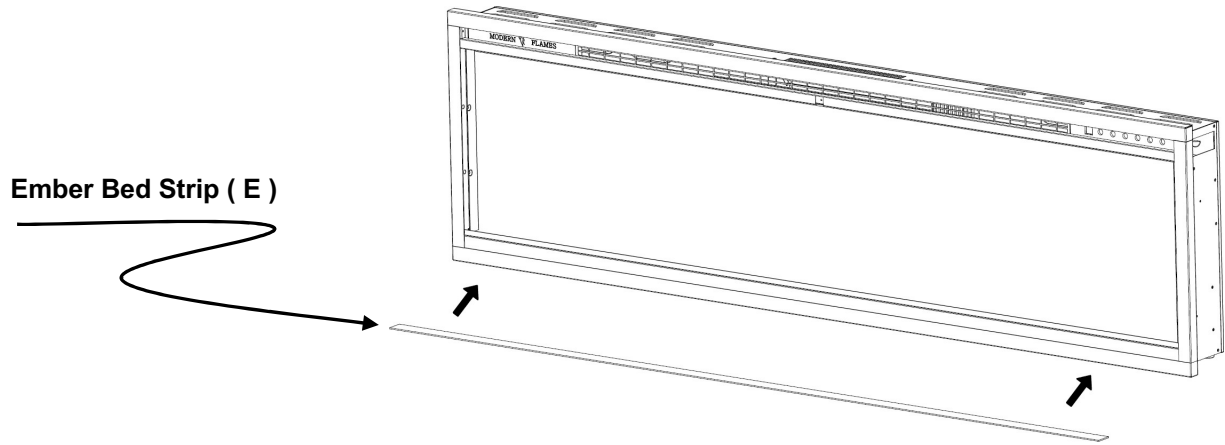

50" Set Contains 8 Logs



60" Set Contains 9 Logs



74" Set Contains 12 Logs



100" Set Contains 16 Logs



Spectrum Slim
Log Set Sizes:
50", 60", 74" & 100"

Log sets may vary and are subject to change.

Operation



Read and understand this entire owner's manual, including **all safety information**, before plugging in or using this product. Failure to do so could result in **electric shock, fire, serious injury, or death.**

Power

Plug the power cord into a dedicated 110~120 Volt 15 Amp grounded outlet (see **IMPORTANT SAFETY INFORMATION** on **Pages 2 and 3**). Make sure the outlet is in good condition and the plug is not loose. **NEVER** exceed the maximum amperage for the circuit. **DO NOT** plug other appliances into the same circuit.

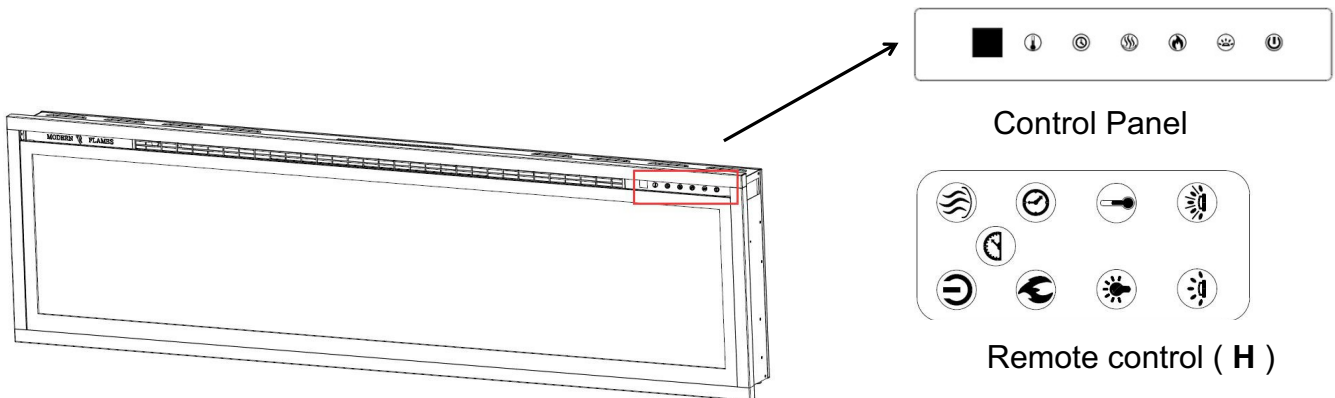

Methods of Operation

This electric fireplace can be operated by the TOUCH ON CONTROL PANEL, located on the UPPER right corner of the fireplace or by the battery-powered REMOTE CONTROL.







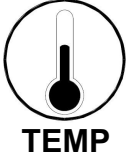

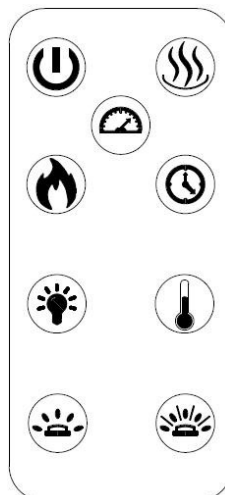
Touch-on Control Panel Operation



BUTTON	FUNCTION	ACTION & INDICATION
 POWER	<p>ON: Enables control panel functions and remote control. Turns on flame.</p> <p>OFF: Disables control panel functions and remote control. Turns off flame.</p>	<p>1. Press once: Indicator light turns on. Power turns on. All functions enabled.</p> <p>2. Press again: Flame turns off. Unit goes to standby. All functions turn off.</p>
 MEDIA	<p>MEDIA BED button: Turns on media bed and changes color.</p> <p>NOTE: color effect stays on until power button is turned off.</p> <p>NOTE: this fireplace has memory function for ember bed.</p>	<p>1. Press once: Turns on ember bed.</p> <p>2. Press again until desired color is reached. In total ten colors and one fade mode.01-02-03-04-05-06-07-08-09-10-11</p>

	<p>FLAME button: Changes flame color.</p> <p>NOTE: color effect stays on until power button is turned off.</p> <p>NOTE: this fireplace has memory function for flame.</p>	<p>1. Press once: Flame color illuminates.</p> <p>2. Press again until desired color is reached. In total, ten colors for flame and one fade mode From 01-02-03-04-05-06-07-08-09-10-11.</p>																																							
	<p>HEATER button: Turns heater on and off.</p> <p>NOTE: The heater only works when the flame is on. If the flame is off, the heater will not turn on.</p> <p>NOTE: To prevent overheating, the heater fan will blow cool air for 8-10 seconds before the heater turns on and after the heater turns off.</p>	<p>Turns the heater and blower on/off.</p> <p>Settings:</p> <p>H0 - Heater and blower off</p> <p>H1 - Low Heater on with 733W</p> <p>H2 - High Heater on with 1465W</p> <p>NOTE: Press and hold the heater button for 5 seconds to lock/unlock the heater and thermostat.</p>																																							
	<p>TIMER button: Controls timer settings to turn off fireplace at selected time.</p> <p>Settings range from 30min to 8 hours.</p>	<p>1. Press once: Indicator light turns on. Timer defaults to 0.5 hours.</p> <p>2. Press again until desired setting is reached.</p>																																							
	<p>1. Press once: Touch panel indicator becomes active.</p> <p>2. Press again until desired temperature is reached. Digital display shows settings 0-10.</p> <p>Table below shows corresponding temperatures:</p> <table border="1" data-bbox="277 1108 1507 1251"> <thead> <tr> <th>NO</th> <th>0</th> <th>1</th> <th>2</th> <th>3</th> <th>4</th> <th>5</th> <th>6</th> <th>7</th> <th>8</th> <th>9</th> <th>10</th> <th>N</th> </tr> </thead> <tbody> <tr> <td>°C</td> <td>20</td> <td>21</td> <td>22</td> <td>23</td> <td>24</td> <td>25</td> <td>26</td> <td>27</td> <td>28</td> <td>29</td> <td>30</td> <td>C</td> </tr> <tr> <td>°F</td> <td>68</td> <td>70</td> <td>72</td> <td>74</td> <td>76</td> <td>78</td> <td>80</td> <td>82</td> <td>84</td> <td>86</td> <td>88</td> <td>F</td> </tr> </tbody> </table> <p>NOTE: Press the button for 5 seconds to switch between ° C and ° F</p>		NO	0	1	2	3	4	5	6	7	8	9	10	N	°C	20	21	22	23	24	25	26	27	28	29	30	C	°F	68	70	72	74	76	78	80	82	84	86	88	F
NO	0	1	2	3	4	5	6	7	8	9	10	N																													
°C	20	21	22	23	24	25	26	27	28	29	30	C																													
°F	68	70	72	74	76	78	80	82	84	86	88	F																													



Remote Control Operation

BUTTON	FUNCTION	ACTION & INDICATION
 POWER	<p>ON: Enables control panel functions and remote control. Turns on flame.</p> <p>OFF: Disables control panel functions and remote control. Turns off flame.</p>	<ol style="list-style-type: none"> Press once: Indicator light turns on. Power turns on. All functions enabled. Press again. Flame turns off. Unit goes to standby. All functions turn off.
 FLAME SPEED	<p>Flame speed button: Controls the speed of the flame. There are 3 flame speed settings: 01 (slowest), 02 (Medium), 03 (fastest).</p>	<ol style="list-style-type: none"> Press once: Indicates current flame speed. Press again until desired setting is reached. Display shows the setting. <p>The Default setting is 02 (medium speed)</p>
 FLAME	<p>FLAME button: Changes flame color.</p> <p>NOTE: color effect stays on until power button is turned off.</p> <p>NOTE: this fireplace has memory function for flame.</p>	<ol style="list-style-type: none"> Press once: Flame color illuminates. Press again until desired color is reached. In total, ten colors for flame and one fade mode. From 01-02-03-04-05-06-07-08-09-10-11.
 FLAME BRIGHTNESS	<p>FLAME brightness button: Makes flame dimmer and brighter.</p> <p>NOTE: Flame stays on until power button is turned off.</p>	<ol style="list-style-type: none"> Press once: Flame brightness enabled. Press again until desired setting is reached. From F5-F4-F3-F2-F1
 HEATER	<p>HEATER button: Turns heater on and off.</p> <p>NOTE: The heater only works when the flame is on. If the flame is off, the heater will not turn on.</p> <p>NOTE: To prevent overheating, the heater fan will blow cool air for 8-10 seconds before the heater turns on and after the heater turns off.</p>	<p>Turns the heater and blower on/off.</p> <p>Settings:</p> <p>H0 - Heater and blower off</p> <p>H1 - Low Heater on with 733W</p> <p>H2 - High Heater on with 1465W</p> <p>NOTE: Press and hold the heater button for 5 seconds to lock/unlock the heater and thermostat.</p>
 TIMER	<p>TIMER button: Controls timer settings to turn off fireplace at selected time.</p> <p>Settings range from 30min to 8 hours.</p>	<ol style="list-style-type: none"> Press once: Indicator light turns on. Timer defaults to 0.5 hours. Press again until desired setting is reached.

 TEMP	<p>1. Press once: Touch panel indicator becomes active.</p> <p>2. Press again until desired temperature is reached. Digital display shows settings 0-10.</p> <p>Table below shows corresponding temperatures:</p> <table border="1" data-bbox="277 315 1510 457"> <tr> <td>NO</td> <td>0</td> <td>1</td> <td>2</td> <td>3</td> <td>4</td> <td>5</td> <td>6</td> <td>7</td> <td>8</td> <td>9</td> <td>10</td> <td>N</td> </tr> <tr> <td>°C</td> <td>20</td> <td>21</td> <td>22</td> <td>23</td> <td>24</td> <td>25</td> <td>26</td> <td>27</td> <td>28</td> <td>29</td> <td>30</td> <td>C</td> </tr> <tr> <td>°F</td> <td>68</td> <td>70</td> <td>72</td> <td>74</td> <td>76</td> <td>78</td> <td>80</td> <td>82</td> <td>84</td> <td>86</td> <td>88</td> <td>F</td> </tr> </table> <p>NOTE: Press the button for 5 seconds to switch between ° C and ° F</p>		NO	0	1	2	3	4	5	6	7	8	9	10	N	°C	20	21	22	23	24	25	26	27	28	29	30	C	°F	68	70	72	74	76	78	80	82	84	86	88	F
NO	0	1	2	3	4	5	6	7	8	9	10	N																													
°C	20	21	22	23	24	25	26	27	28	29	30	C																													
°F	68	70	72	74	76	78	80	82	84	86	88	F																													
 MEDIA	<p>MEDIA BED button: Turns on media bed and changes color.</p> <p>NOTE: color effect stays on until power button is turned off.</p> <p>NOTE: this fireplace has memory function for ember bed.</p>	<p>1. Press once: Turns on ember bed.</p> <p>2. Press again until desired color is reached. In total ten colors and one fade mode.01-02-03-04-05-06-07-08-09-10-11</p>																																							
 MEDIA BRIGHTNESS	<p>MEDIA brightness button: Makes media bed dimmer and brighter.</p> <p>NOTE: LED MEDIA light brightness stays on until power button is turned off.</p>	<p>1. Press once: Brightness becomes active.</p> <p>2. Press again until desired setting is reached. In total 5 levels.</p> <p>From L5 - L4 - L3 - L2 - L1</p>																																							

NOTICE When the heater is first turned on, a slight odor may be present. This is normal and should not occur again unless the heater is not used for a long period of time.

NOTICE To improve operation, **aim** the remote control at the front of the fireplace. **DO NOT press the buttons too quickly.** Give the unit time to respond to each command.

Temperature Limiting Control

This heater is equipped with a Temperature Limiting Control. Should the heater reach an unsafe temperature, the heater will automatically turn OFF. To reset:

1. Unplug the power cord from the outlet. Wait 5 minutes.
2. Inspect the fireplace to make sure no vents are blocked or clogged with dust or lint. If they are, use a vacuum to clean the vent areas.
3. Plug the power cord back into the outlet.
4. If the problem continues, have your outlet and wiring inspected by a professional.

Remote Control Battery Information

- Remote control uses one **CR2025** battery (**Included**)



NEVER dispose of batteries in **fire**. Failure to observe this precaution **may result in an explosion**. Dispose of batteries at your local hazardous material processing center.

Care and Maintenance

Cleaning



ALWAYS turn the heater **OFF** and **unplug the power cord from the outlet** before cleaning, performing maintenance, or moving this fireplace. Failure to do so could result in **electric shock, fire, or personal injury**.



NEVER immerse in **water** or **spray with water**. Doing so could result in **electric shock, fire, or personal injury**.

Metal:

- Clean using a soft cloth, slightly dampened with soapy water.
- **DO NOT** use brass polish or household cleaners as these products will damage the metal trim.

Glass:

- Use a good quality glass cleaner sprayed onto the cloth or towel. Dry thoroughly with a paper towel or lint-free cloth.
- **NEVER** use abrasive cleansers, liquid sprays, or any cleaner that could scratch the surface.

Vents:

- Use a vacuum or duster to remove dust and dirt from the heater and vent areas.

Plastic:

- Wipe gently with a slightly damp cloth and a mild solution of dish soap and warm water.
- **NEVER** use abrasive cleansers, liquid sprays, or any cleaner that could scratch the surface.

Maintenance



Risk of electric shock! DO NOT OPEN any panels! No user-serviceable parts inside!



ALWAYS turn the heater **OFF** and **unplug the power cord from the outlet** before cleaning, performing maintenance, or moving this fireplace. Failure to do so could result in **electric shock, fire, or personal injury**.

Electrical and Moving Parts:

- The fan motors are lubricated at the factory and will not require lubrication.
- Electrical components are integrated in the fireplace and are not serviceable by the consumer.

Storage:

- Store heater in a clean dry place when not in use.



WARNING! NO SERVICING of the internal or electrical parts should be performed by the consumer. Do not service the unit yourself.

Spare Parts List

Spare Parts

SPARE PART DESCRIPTION	MODERN FLAMES PART NUMBERS			
	Model: SPS-50B-XX	Model: SPS-60B-XX	Model: SPS-74B-XX	Model: SPS-100B-XX
FRONT GLASS	04-00001	04-00002	04-00003	04-00004
ACRYLIC PLASTIC PANEL	03-00001	03-00002	03-00003	03-00004
STEP MOTOR	01-00001			
BLOWER	01-00002 (01-00023 AU & EU)			
HEATER	01-00010 (01-00022 AU & EU)			
LED FLAME LIGHT	01-00003			
LED EMBER LIGHT	01-00004			
REMOTE CONTROL	01-00005			
TOUCH-ON CONTROL PANEL	01-00006			
REMOTE RECEIVER	01-00026			
CIRCUIT BOARD	01-00007			
POWER BOARD	01-00008			
THERMOSTAT (NTC)	01-00009			
FRONT METAL TRIM KIT, TOP/BOTTOM (2 PIECE)	02-00100	02-00101	02-00102	02-00103
FRONT METAL TRIM KIT, LEFT/RIGHT (2 PIECES)	02-00099			
GLASS FACE FOR TOUCH CONTROL	04-00013			
MODERN FLAMES LIGHT UP GLASS LOGO	04-00014			
PLASTIC STRIP	03-00005	03-00006	03-00007	03-00008
WALL MOUNTING BRACKET	02-00001	02-00002		
REFLECTOR SPINDLE	02-00003	02-00004	02-00005	02-00006
HARDWARE KIT	02-00010			
CRYSTAL, CLEAR	GC Diamond 3.5			
CRYSTAL, SMOKED	GC Smoke 3.5			
LOG SET	05-00001	05-00002	05-00003	05-00004
METAL SIDE BRACE FOR PLASTIC PANEL	02-00015			
METAL TOP BRACE FOR PLASTIC PANEL	02-00016	02-00017	02-00018	02-00019
FLAME ENHANCER	02-00020	02-00021	02-00022	02-00023
METAL SIDE PANEL FOR WALL MOUNT INSTALL	02-00024			
METAL, RECESS BRACKET, MOUNTING	02-00107			

INDIVIDUAL LOGS	PART NUMBERS
LOG #1	05-00005
LOG #2	05-00006
LOG #3	05-00007
LOG #4	05-00008
LOG #5	05-00009
LOG #6	05-00010
LOG #7	05-00011
LOG #8	05-00012
LOG #9	05-00013
LOG #10	05-00014
LOG #11	05-00015
LOG #12	05-00016

DO NOT RETURN TO STORE!



CALL US FIRST

For immediate help with installation, product information or if your product arrives damaged, please call our toll free number at:

1-877-246-9353

(Monday - Friday, 8:00AM - 5:00PM, AZ Mountain Time)

Or email us at:

customerservice@modernflames.com

OUR STAFF IS READY TO PROVIDE ASSISTANCE