

HOMEOWNER'S MANUAL

INSTALLER:

Leave this manual with the appliance.

CONSUMER:

Retain this manual for future reference.

⚠ WARNING

FIRE OR EXPLOSION HAZARD

Failure to follow safety warnings exactly could result in serious injury, death, or property damage.

- Do not store or use gasoline or other flammable vapors and liquids in the vicinity of this or any other appliance.
- **WHAT TO DO IF YOU SMELL GAS**
 - Do not try to light any appliance.
 - Do not touch any electrical switch; do not use any phone in your building.
 - Leave the building immediately.
 - Immediately call your gas supplier from a neighbor's phone. Follow the gas supplier's instructions.
 - If you cannot reach your gas supplier, call the fire department.
- Installation and service must be performed by a qualified installer, service agency or the gas supplier.

DIRECT VENT ZERO CLEARANCE GAS FIREPLACE HEATER SERIES: DVCT40CSP95(N,P)-1

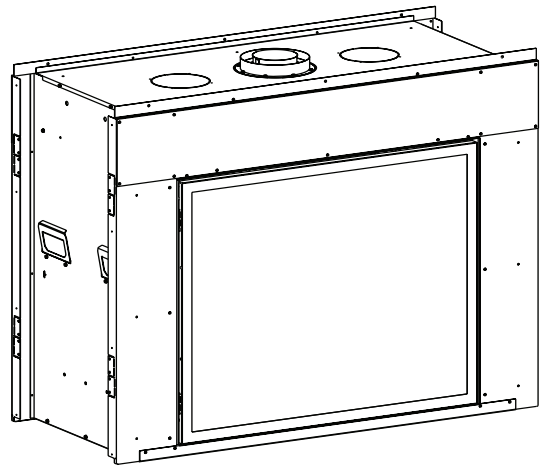

This appliance may be installed in an aftermarket, permanently located, manufactured home (USA only) or mobile home, where not prohibited by local codes.

This appliance is only for use with the type of gas indicated on the rating plate. This appliance is not convertible for use with other gases, unless a certified kit is used.



DANGER



**HOT GLASS WILL
CAUSE BURNS.
DO NOT TOUCH GLASS
UNTIL COOLED.
NEVER ALLOW CHILDREN
TO TOUCH GLASS.**

A barrier designed to reduce the risk of burns from the hot viewing glass is provided with this appliance and shall be installed for the protection of children and other at-risk individuals.

NATIONAL
FIREPLACE
INSTITUTE



CERTIFIED

www.nficertified.org

We suggest that our gas hearth products be installed and serviced by professionals who are certified in the U.S. by the National Fireplace Institute® (NFI) as NFI Gas Specialists.

GAS-FIRED



UL FILE NO. MH30033

This fireplace is design certified in accordance with American National Standard/CSA Standard ANSI Z21.88/CSA 2.33 and by Underwriters Laboratories as a Direct Vent Gas Fireplace Heater and shall be installed according to these instructions.

TABLE OF CONTENTS

SECTION	PAGE
Multifunction Remote Operating Instructions	3-9
Lighting Instructions	10
Maintenance And Service	11-12
Important Safety Information	13
Safety Information For Users Of Propane Gas	14
Requirements For Massachusetts	15
Warranty	16

COMBUSTIBLE MATERIAL

WARNING

Do not attach combustible material above your fireplace. This is a fire hazard. No greeting card, stockings or ornamentation of any type should be placed on or attached to the fireplace. This is a heating appliance. The flow of heat can ignite combustibles.

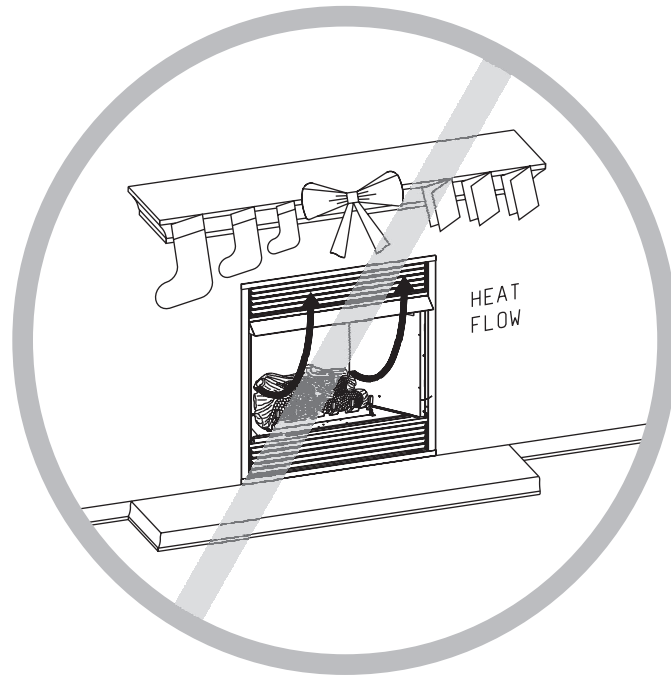

Figure 1
GENERIC MODEL SHOWN

MULTIFUNCTION REMOTE OPERATING INSTRUCTIONS

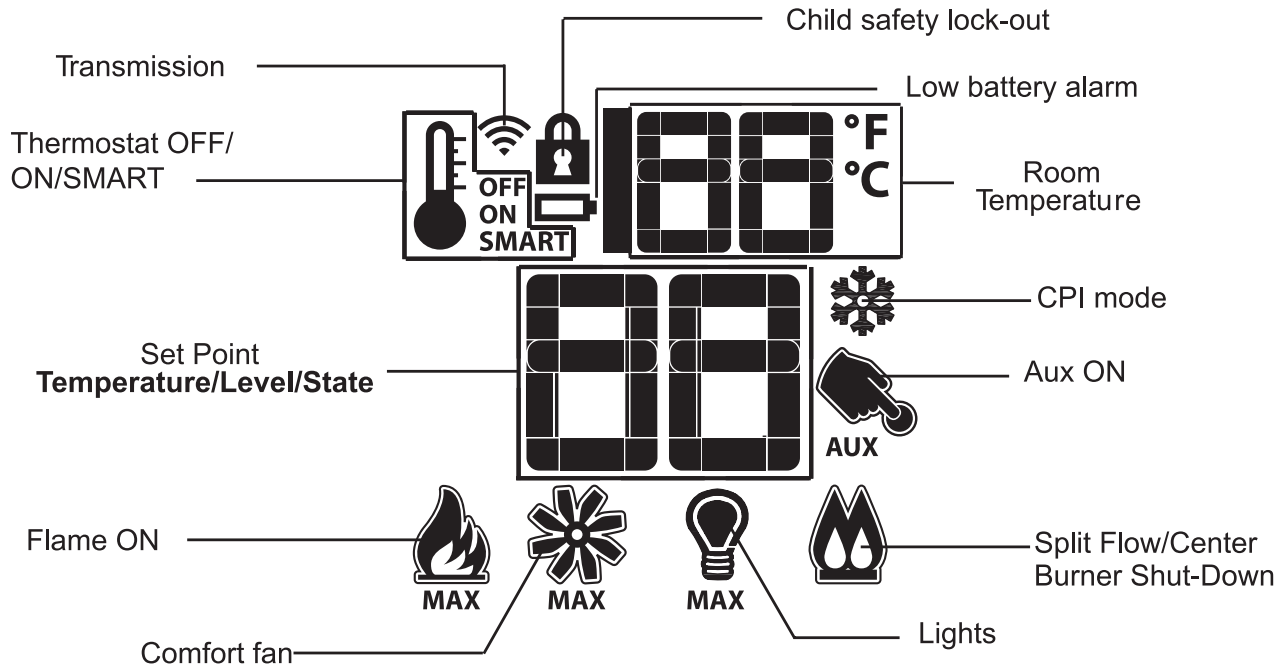

Figure 2

TECHNICAL DATA	
Remote Control	
Supply voltage	4.5 V (three 1.5 V AAA batteries)
Ambient temperature ratings	0-50°C (32 - 122°F)
Radio frequency	315 MHz

⚠ WARNING
The transmitter and receiver are radio frequency devices. Placing the receiver in or near metal may severely reduce the signal range.

⚠ WARNING
Turn "off" the main gas supply and electrical supply to the appliance during installation and/or maintenance of the receiver device.

⚠ WARNING
FIRE HAZARD. CAN CAUSE SEVERE INJURY OR DEATH.
The Receiver causes ignition of the appliance. The appliance can turn on suddenly. Keep away from the appliance burner when operating the remote system or activating manual bypass of the remote system.

⚠ CAUTION
PROPERTY DAMAGE HAZARD.
EXCESSIVE HEAT CAN CAUSE PROPERTY DAMAGE.
The appliance can stay lit for many hours. Turn off the appliance if it is not going to be attended for any length of time. Always place the Transmitter where children can not reach it.

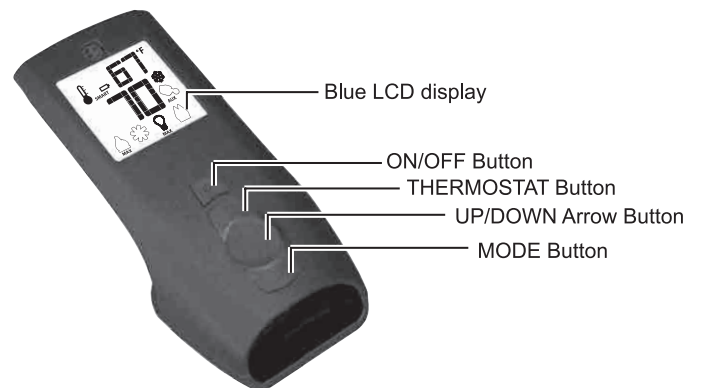

Figure 3

NOTE: This control system includes a Battery Back-up pack that allows the Fireplace to operate in the event of a power outage.

NOTE: The Accent Light and/or Blower features will not operate during a power outage.

NOTE: Replace all Batteries at least once each year, preferably before at the beginning of the season.

⚠ CAUTION
FIRE OR EXPLOSION HAZARD.
Can cause property damage, sever injury or death. Do not attempt to take apart the gas control or to clean it. Improper assembly and cleaning can cause unreliable operation.

MULTIFUNCTION REMOTE OPERATING INSTRUCTIONS

Initializing the System for the First Time

1. Remove the wall cover. Remove cover on the wall mounted battery back-up holder. **See Figure 4.** Install the four AA batteries into the wall mounted battery back-up holder then reinstall the cover. **See Figure 5.**
2. Install three AAA batteries into the battery bay located on the base of the transmitter. **See Figure 6.**
3. Set the wall remote slide switch to the "REMOTE" position. **See Figure 5.**
4. Press and release the SWI button on the wall control with a paper clip and the IFC module will beep three times to indicate the IFC module is ready to synchronize with the transmitter within ten seconds. **See Figure 5.**

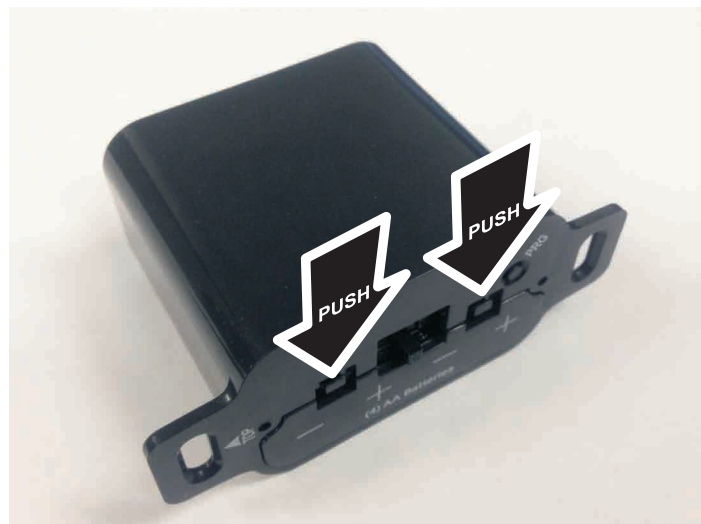

Figure 4



Figure 5

5. With the batteries already installed in the Transmitter, push the On button. The Receiver will "beep" four times to indicate the Transmitter's command is accepted and sets to the particular code of that Transmitter. The system is now initialized.



Figure 6

Temperature Indication Display °C or °F

With the system in the "OFF" position, press the Thermostat Button and the Mode Button at the same time. Look at the LCD screen on the Transmitter to verify that a °C or °F is visible to the right of the Room Temperature display. **See Figures 7 and 8.**

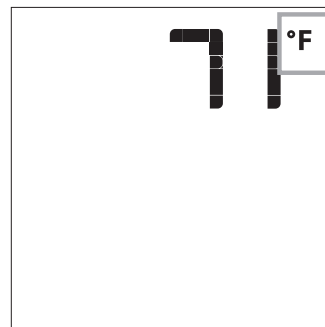

Figure 7



Figure 8

MULTIFUNCTION REMOTE OPERATING INSTRUCTIONS

Turn On the Appliance

With the system OFF, press the ON/OFF Button on the Transmitter. The Transmitter display will show some other active Icons on the screen. At the same time the Receiver will activate the appliance. A single “beep” from the Receiver will confirm reception of the command.

Turn OFF the Appliance

With the system ON, press the ON/OFF Button on the Transmitter. The Transmitter LCD display will only show the room temperature. **See Figure 9.** At the same time the Receiver will turn off the appliance. A single “beep” from the Receiver confirms reception of the command.

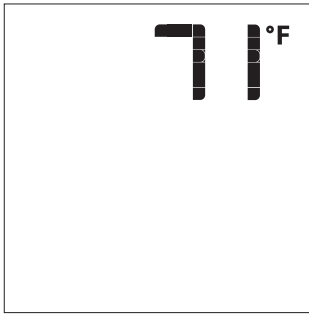

Remote Control Display - Figure 9

Remote Flame Control

The Proflame has six flame levels. With the system on, and the flame level at the maximum in the appliance, pressing the Down Arrow Button once will reduce the flame height by one step until the flame is turned off.

The Up Arrow Button will increase the flame height each time it is pressed. If the Up Arrow Button is pressed while the system is on but the flame is off, the flame will come on in the high position.

See Figures 10 through 13. A single “beep” will confirm reception of the command.



Flame Off - Figure 10

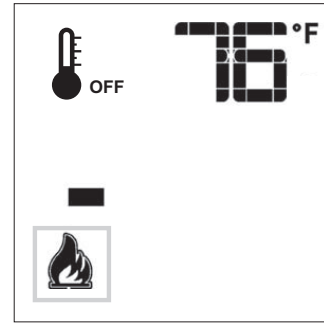

Flame Level 1 - Figure 11

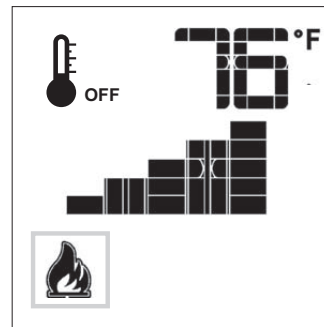

Flame Level 5 - Figure 12

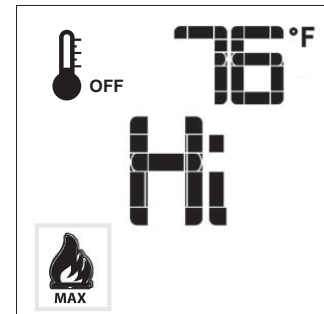

Flame Level Maximum - Figure 13

MULTIFUNCTION REMOTE OPERATING INSTRUCTIONS

The Thermostat Feature may be disabled if desired.

With all three AAA type batteries installed:

1. Take out one AAA battery.
2. While re-inserting the AAA battery, Push and hold down the thermostat button. This will disable the thermostat feature on the transmitter.

Room Thermostat (Transmitter Operation)

The Remote Control can operate as a room thermostat. The thermostat can be set to a desired temperature to control the comfort level in a room. To activate this function, press the Thermostat Button. **See Figure 3.** The LCD display on the Transmitter will change to show that the room thermostat is "ON" and the set temperature is now displayed. **See Figure 14.** To adjust the set temperature, press the Up or Down Arrow Buttons until the desired set temperature is displayed on the LCD screen of the Transmitter. **See Figure 15.**

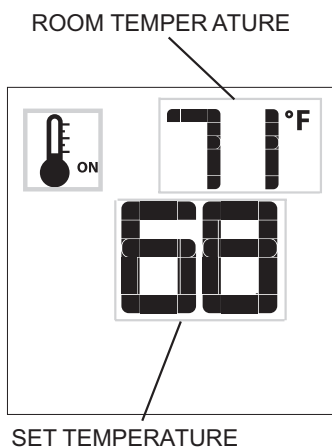

Figure 14

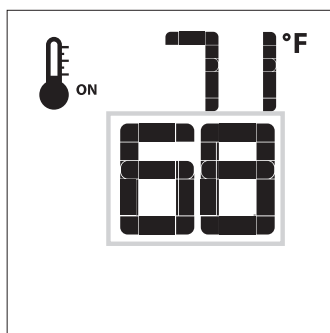

Figure 15

Smart Thermostat (Transmitter Operation)

The Smart Thermostat function adjusts the flame height in accordance to the difference between the set point temperature and the actual room temperatures. As the room temperature gets closer to the set point the Smart Function will modulate the flame down. To activate this function, press the Thermostat Button until the word "SMART" appears to the right of the temperature bulb graphic. **See Figure 16.** To adjust the set temperature, press the Up or Down Arrow Buttons until the desired set temperature is displayed on the LCD screen of the Transmitter. **See Figure 17.**

NOTE: When Smart Thermostat is activated, manual flame height adjustment is disabled.

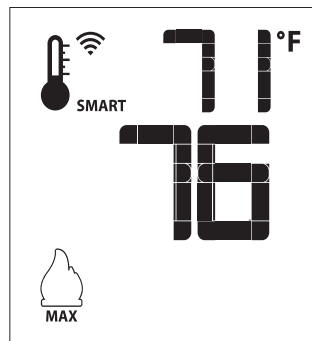

Figure 16

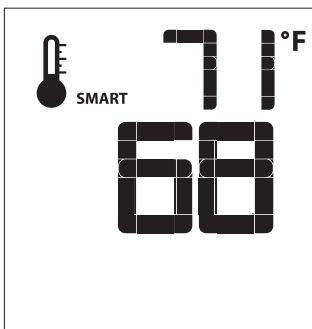

Figure 17

Blower Control (Fan)

If the appliance is equipped with a hot air circulating fan, the speed of the fan can be controlled by the Proflame system. The fan speed can be adjusted through six speeds. To activate this function, use the Mode Button **Figure 3** to index the fan control icon. **See Figure 18.** Use the Up/Down Arrow Buttons **Figure 56** to turn on off or adjust the fan speed. **See Figure 19.** A single "beep" will confirm reception of the command.



Figure 18

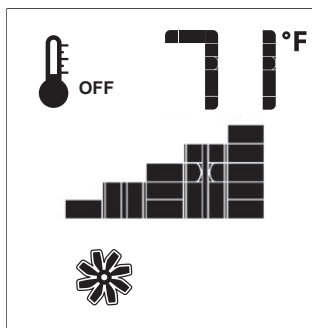

Figure 19

MULTIFUNCTION REMOTE OPERATING INSTRUCTIONS

Remote Dimmer Control (Light)

The auxiliary function controls the power light outlet by the dimmable light control. To activate this function, use the Mode Button **Figure 3** to index to the light icon. **See Figures 20 and 21.** The intensity of the output can be adjusted through six levels. Use the Up/Down Arrow Buttons **Figure 3** to adjust the output level. A single “beep” will confirm reception of the command.

NOTE: This function is available only with the IFC control Module.

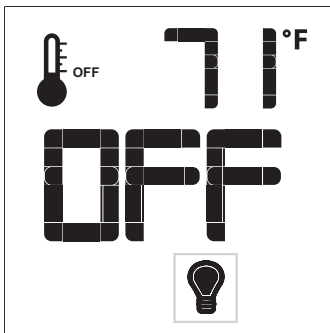

Figure 20

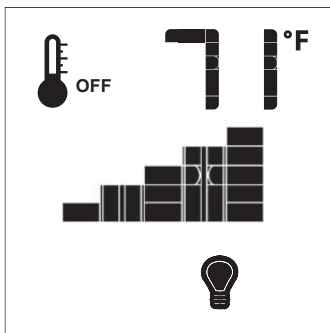

Figure 21

Split Flow Control

The secondary burner is controlled by the split Flow. To activate this function use the Mode Button **Figure 3** to index to the SPLIT FLOW mode icon. **See Figures 22 and 23.**

Pressing the Up Arrow Button will activate the secondary burner. Pressing the Down Arrow Button will turn the secondary burner off. A single “beep” will confirm the reception of the command.

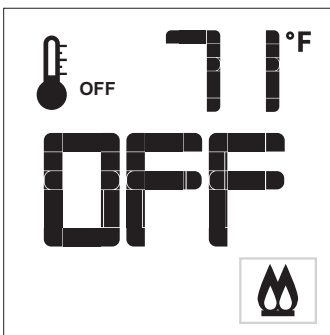

Figure 22

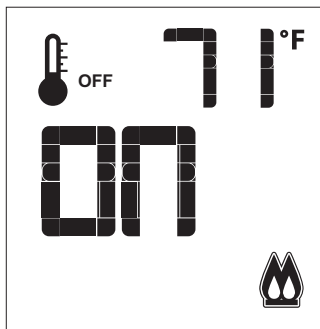

Figure 23

Remote Auxiliary Relay Control (optional with this fireplace)

The auxiliary function controls the AUX relay outlet. To activate this function use the Mode Button **Figure 3** to index to the AUX icon **Figures 24 & 25.** Pressing the Up Arrow Button will activate the outlet. Pressing the Down Arrow Button will turn the outlet off. A single “beep” will confirm the reception of the command.

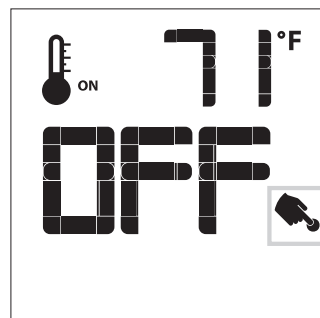

Figure 24

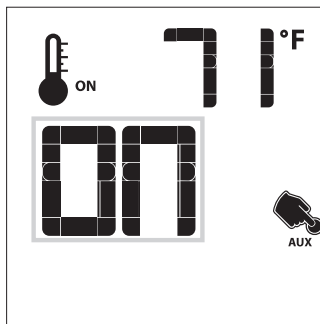

Figure 25

MULTIFUNCTION REMOTE OPERATING INSTRUCTIONS

Continuous Pilot/ Intermittent Pilot (CPI/IPI) Selection

With the system in "OFF" position press the Mode Button **Figure 3** to index to the CPI mode icon. **See Figures 26 and 27.** Pressing the Up Arrow Button will activate the (CPI). Pressing the Down Arrow Button will return to IPI. A single "beep" will confirm the reception of the command.

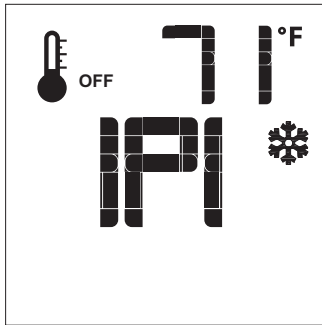

Figure 26

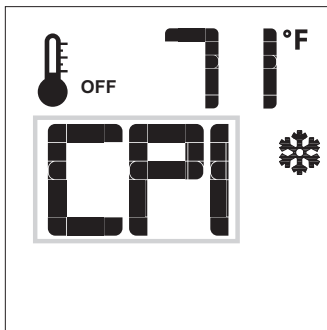

Figure 27

Button Lock

This function will lock the Buttons to avoid unsupervised operation. To activate this function, press the MODE and UP Buttons at the same time. **See Figure 28.**

To deactivate this function, press the MODE and UP Buttons at the same time.

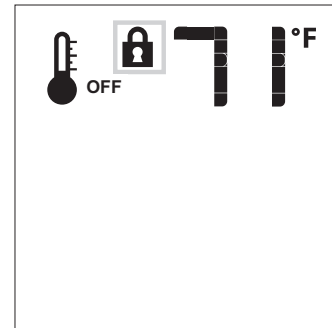

Figure 28

Low Battery Power Detection - Transmitter

The life span of the remote control batteries depends on various factors: quality of the batteries used, the number of ignitions of the appliance, the number of changes to the room thermostat set point, etc.

When the transmitter batteries are low, an Icon will appear on the LCD display of the transmitter **See Figure 29** before all battery power is lost. When the batteries are replaced this Icon will disappear.

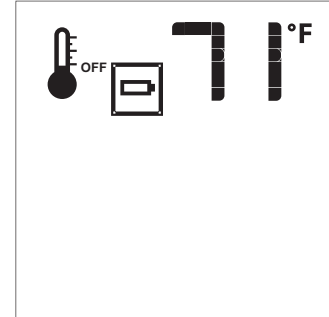

Figure 29

MULTIFUNCTION REMOTE OPERATING INSTRUCTIONS

Using the Fireplace without a Remote Control

The fireplace can be turned ON (HI only) and OFF with the wall switch. The fireplace flame ON/OFF is the only function that will operate; no flame adjustment, light or blower will work when using the wall switch. The wall control switch should be turned OFF when the fireplace is not being used for extended periods of time.

Battery Backup Operation

Install batteries (See initialization sequence on page 44). In case of power loss, the fireplace will switch to battery mode automatically. The fireplace will operate normally without the fan or light control when in battery mode.

Low Battery Detection

When the backup batteries are low, a double-beep will be emitted when the module receives an on/off command. No commands will be accepted until the batteries are replaced or the A/C power is restored.

Lockout State Definition

A lockout state is reached when an ignition error occurs. The lockout state will remain set in memory as long as the power supplies are applied.

This could mean both an irregular flame detection and/or too many unsuccessful ignition attempts.

This state is a safe condition for the appliance and is entered automatically by the IFC board.

When the IFC board gets into lockout state:

1. both the Pilot and the Main Burner solenoids in the gas valve are de-energized;
2. a diagnostic code is sent through the diagnostic red LED.
3. the IFC board will ignore any burner ignition command and remain in the OFF state unless the unlock command sequence is met.

The causes of lockout must be investigated under safe conditions by the user and/or the service personnel.

To reset the IFC from a lockout state, perform the following procedure:

Turning the system power supplies (to the wall control or remote control) OFF for two or three seconds and then restoring a power supply back on.

The return of the system to normal operation must be checked under safe conditions by the user and/or service personnel.

LIGHTING INSTRUCTIONS



FOR YOUR SAFETY READ BEFORE LIGHTING

⚠ WARNING

If you do not follow these instructions exactly, a fire or explosion may result causing property damage, personal injury or loss of life.

- A. This appliance must be lighted with the remote control. When lighting the pilot, follow these instructions exactly.
- B. **BEFORE LIGHTING**, smell around the appliance area for gas. Be sure to smell next to the floor because some gases are heavier than air and will settle on the floor.
- WHAT TO DO IF YOU SMELL GAS**
- Do not try to light any appliance.
 - Do not touch any electrical switch.
 - Do not use any phone in your building.
 - Immediately call your gas supplier from a neighbor's phone. Follow the gas supplier's instructions. If you can not reach your gas supplier, call the fire department.
- C. Use only the remote control to operate the valve. Never use tools. If valve does not operate, don't try to repair it, call a qualified service technician. Force or attempted repair may result in a fire or explosion.
- D. Do not use this appliance if any part has been underwater. Immediately call a qualified service technician to inspect the appliance and to replace any part of the control system and any gas control which has been underwater.

LIGHTING INSTRUCTIONS

1. STOP! Read the safety information above.
2. Turn OFF electric power to the appliance.
3. Turn gas shut-off knob counterclockwise  to "ON" position.
4. Wait ten minutes to clear out any gas. Then smell for gas, including near the floor. If you smell gas, STOP! Follow "B" in the safety information above on this label. If you do not smell gas, go to the next step.
5. Turn ON electric power to the appliance.
6. Using the remote control, turn main flame to "ON." Refer to the Multifunction Remote Operating Instructions for more information. If the pilot does not light within 60 seconds, stop and go back to Step 4.
7. Refer to remote control instructions for detailed information, control features, and operation. Note: Refer to Multifunction Remote operating instructions for selection of continuous standing pilot mode or intermittent pilot mode. If the pilot or burner does not stay lit (in the standing pilot mode), stop and immediately call a qualified service technician or gas supplier.
8. If the burner or pilot does not operate properly after several tries, turn the gas shut-off knob clockwise  to "OFF" and call your service technician or gas supplier.
9. Operation of the gas valve, blower, and/or optional light must be controlled by using the hand held remote control. Refer to remote instructions for detailed operation information.

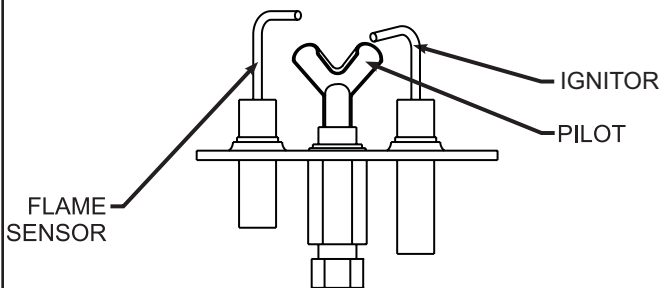

GAS SHUT-OFF VALVE

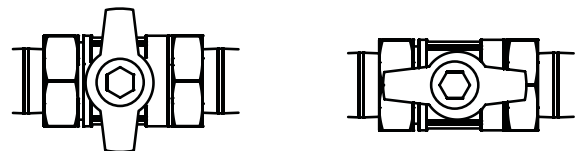

OFF

ON

TO TURN OFF GAS TO APPLIANCE

1. Turn off all electric power to the appliance if service is to be performed (if applicable).
2. Locate On/Off gas shut-off knob and turn clockwise  "OFF." Do not force.

MAINTENANCE AND SERVICE

NOTE: It is normal for steel appliances to make expansion and/or contraction noise as they heat up or cool-down. Similar noises are found with your furnace heat exchanger or car engine.

It is normal for your gas fireplace to give off some odor the first time it is burned. This is due to the curing of the paint and any oil from the manufacturing process.
If odor becomes offensive, open windows.

Burn the fireplace for at least six hours the first time you use it. If the optional fan kit has been installed, place fan in the "OFF" position during this time.

IMPORTANT: Turn off the gas before servicing appliance. Have a qualified service person perform these check-ups at the beginning of each heating season.

• Clean Burner and Control Compartment

Keep the control compartment, logs, and burner areas surrounding the logs clean by vacuuming or brushing at least twice a year.

Cleaning Procedure

1. Turn off pilot light using your remote. Allow the fireplace to cool completely.
2. Remove glass front and barrier screen. (See glass and barrier screen removal.)
3. Vacuum burner compartment.
4. Re-install glass front and barrier screen.
5. Ignite pilot. (See Lighting Instructions)
6. Operate the pilot burner. If it appears abnormal contact your dealer for service.

• Check Vent System

Inspect the fireplace and venting system before initial use and at least annually. Inspect the external vent cap on a regular basis to make sure no debris interferes with the air flow.

Cleaning the Glass

Clean the glass periodically. We recommend gas fireplace glass cleaner. During start-up, condensation forms on the inside of the glass causing lint, dust and other airborne particles to cling to the glass. Also initial paint curing may deposit a film on the glass. Allow the fireplace to cool and then clean the glass two or three times with gas fireplace glass cleaner or a non-abrasive household cleaner and warm water. After that, clean the glass two or three times during each heating season or more often if necessary.

WARNING

**Clean glass with cleaner designed for fireplaces.
Do not use Ammonia based or abrasive cleaners on glass.
Do not attempt to clean glass when glass is hot.**

Wiring

If any of the original wire supplied with this unit must be replaced, order through parts department.

Glass - General Information

WARNING

Do not operate appliance with the glass front removed, cracked, or broken.

Use only glass approved for use by the fireplace manufacturer for replacement. Glass replacement should be done by a licensed or qualified service person.

WARNING

1. The use of substitute glass will void all product warranties.
2. Avoid breaking the glass.
3. Do not operate this appliance without the glass front or with a broken glass front. Have a qualified service person replace damaged glass and gasket using materials specified by Empire Comfort Systems.
4. Do not abuse or strike the glass.

MAINTENANCE AND SERVICE

Barrier & Glass Removal

1. Lift barrier screen and pull towards you.
2. Use the Glass Latch Tool to grip the latch bar and pry it over the Glass Frame hook flanges. Tilt the Glass Frame towards you and pull upwards to remove it from the unit.

See Figures 30 and 31.

CAUTION

Ensure that the latch tool is completely hooked around the latch before trying to disengage the clips. Glass clips are tightly sprung. If the latch tool slips off of the latch while pulling, injury may occur.

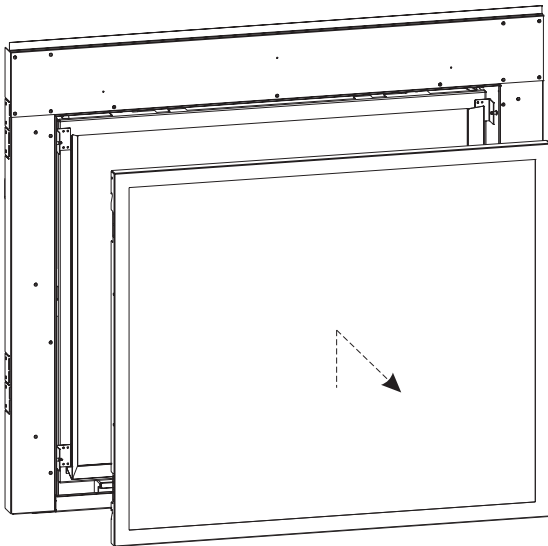

Figure 30

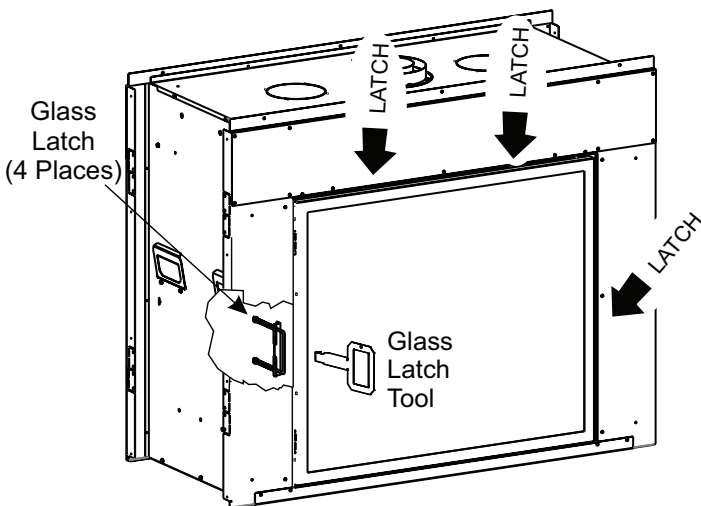

Figure 31

Light Bulb(s) Replacement

1. Remove the following items:

- barrier screen
- glass frame assembly

This unit comes standard with two lights that are attached to the roof of the fireplace. To access the light bulb you will remove the following items by removing four screws per light, See Figure 32.

- metal bezel
- glass
- gasket

NOTE: Use gloves when handling light bulb, oils on your hand will diminish the life span of the light bulb.

2. Remove old light bulb and replace with a new one.

See Figure 33.

NOTE: You may order light bulbs from your local Empire dealer or purchase them from your local hardware store.

LIGHT BULB SPECIFICATIONS

35w Clear Halogen, Bi-Pin 6.35mm base, 120vac, UL

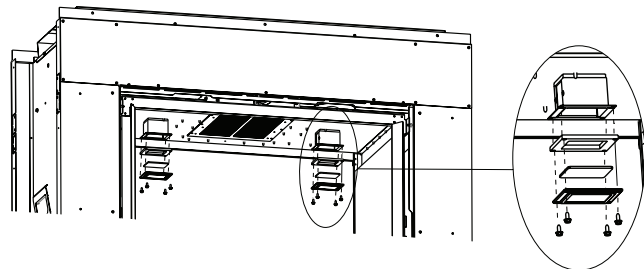

Figure 32

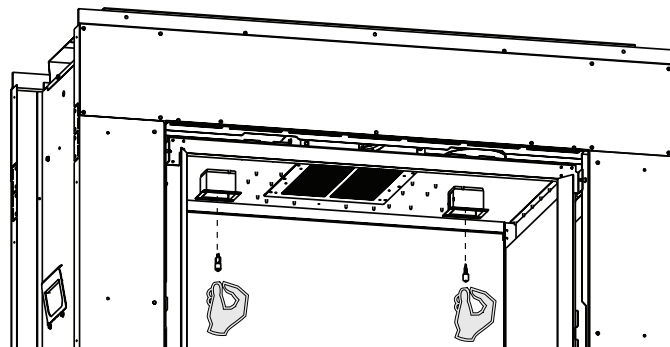

Figure 33

IMPORTANT SAFETY INFORMATION

FOR THE HOMEOWNER

- This fireplace must be installed and serviced by your dealer or a qualified service technician. Other than cleaning the glass and replacing the light bulbs, there are no user-serviceable components.
- Keep the area around the fireplace clean and free of debris. This fireplace requires an unimpeded flow of air to circulate warm air. Do not place objects on or around the fireplace that may restrict air flow.
- Keep the area around the fireplace free of combustible materials – including drapery, upholstered furniture, paper, boxes, and clothing. Never hang stockings or cards above the fireplace.
- Never operate the fireplace with the glass front removed or damaged. Any part removed for cleaning or servicing must be replaced prior to operating the fireplace.
- The fireplace gets hot during operation and may remain hot for an hour after use. When operated by thermostat, the fireplace will turn on and off automatically.
- This fireplace may become hot enough to burn skin and ignite clothing after prolonged contact. To prevent injury, alert people in your home – especially children – to the hazards of high surface temperatures and warn them to stay away from the fireplace.
- Supervise children whenever the fireplace is hot. Young children and others may be susceptible to accidental contact burns. Have your dealer install a physical barrier if there are at-risk individuals in your home. To restrict access to a fireplace or stove, install an adjustable safety gate to keep toddlers, young children, and other at-risk individuals out of the room and away from hot surfaces.
- The vent cap, located on the outside of your home, will also become very hot. Alert everyone, adults and children, to stay clear and avoid touching the vent cap. Keep the area around the vent cap clear of combustibles, including shrubs and trees.
- Do not use this fireplace if any part has been underwater. Have a qualified technician inspect the fireplace and replace any part that has been underwater. In the event of a natural disaster (tornado, earthquake, fire, etc.) have a qualified technician inspect the fireplace for damage or potential gas leaks. Repair or replace any damaged components before operating this fireplace.
- Never burn solid fuels such as wood, coal, paper or cardboard in this fireplace.

Annual Inspection

- Have the fireplace inspected annually before use.
- More frequent inspection and cleaning may be required if the fireplace is installed in an area exposed to pet hair or dust, or to excessive lint from new carpeting or bedding materials.

During The Annual Checkup, The Technician Will:

- Inspect the pilot (flame safety system) and burner(s) for proper operation and replace any damaged parts.
- Check the glass and gasket for proper seal.
- Vacuum and clean any foreign debris in the firebox that is not supposed to be there.
- Clean Glass with a suitable fireplace glass cleaner. Abrasive cleaners must not be used. Be careful not to scratch the glass when cleaning.
- Check the barrier screen for fit and structural integrity. **See Figure 30.**
- Check all latches or other door retention components for proper operation, tension, and relief mechanisms are free from obstructions. **See Figure 31.**
- Inspect the log set (if applicable) and decorative media (if applicable) for debris or damage.
- Freshen up the glowing embers if applicable.
- Replace batteries in the remote transmitter and receiver if applicable.
- Inspect the venting and vent termination cap for damage, corrosion, sooting, or obstruction and correct if present.
- *In addition, clean and inspect the fireplace following any remodeling work in your home.*

SAFETY INFORMATION FOR USERS OF PROPANE GAS

Propane is a flammable gas which can cause fires and explosions. In its natural state, propane is odorless and colorless. You may not know all the following safety precautions which can protect both you and your family from an accident. Read them carefully now, then review them point by point with the members of your household. Someday when there may not be a minute to lose, everyone's safety will depend on knowing exactly what to do. If, after reading the following information, you feel you still need more information, please contact your gas supplier.

PROPANE GAS WARNING ODOR

If a gas leak happens, you should be able to smell the gas because of the odorant put in the Propane Gas. That's your signal to go into immediate action!

- Do not operate electric switches, light matches, use your phone. Do not do anything that could ignite the gas.
- Get everyone out of the building, vehicle, trailer, or area. Do that IMMEDIATELY.
- Close all gas tank or cylinder supply valves.
- Propane Gas is heavier than air and may settle in low areas such as basements. When you have reason to suspect a gas leak, keep out of basements and other low areas. Stay out until firefighters declare them to be safe.
- Use your neighbor's phone and call a trained Propane Gas service person and the fire department. Even though you may not continue to smell gas, do not turn on the gas again. Do not re-enter the building, vehicle, trailer, or area.
- **Finally**, let the service man and firefighters check for escaped gas. Have them air out the area before you return. Properly trained Propane Gas service people should repair the leak, then check and relight the gas appliance for you.

NO ODOR DETECTED - ODOR FADE

Some people cannot smell well. Some people cannot smell the odor of the chemical put into the gas. You must find out if you can smell the odorant in propane. Smoking can decrease your ability to smell. Being around an odor for a time can affect your sensitivity or ability to detect that odor. Sometimes other odors in the area mask the gas odor. People may not smell the gas odor or their minds are on something else. Thinking about smelling a gas odor can make it easier to smell.

The odorant in Propane Gas is colorless, and it can fade under some circumstances. For example, if there is an underground leak, the movement of the gas through soil can filter the odorant. Odorants in Propane Gas also are subject to oxidation. This fading can occur if there is rust inside the storage tank or in iron gas pipes.

The odorant in escaped gas can adsorb or absorb onto or into walls, masonry and other materials and fabrics in a room. That will take some of the odorant out of the gas, reducing its odor intensity.

Propane Gas may stratify in a closed area, and the odor intensity could vary at different levels. Since it is heavier than air, there may be more odor at lower levels. Always be sensitive to the slightest gas odor. If you detect any odor, treat it as a serious leak. Immediately go into action as instructed earlier.

SOME POINTS TO REMEMBER

- **Learn to recognize the odor of Propane Gas.** Your local Propane Gas Dealer can give you a "Scratch and Sniff" pamphlet. Use it to find out what the propane odor smells like. If you suspect that your Propane Gas has a weak or abnormal odor, call your Propane Gas Dealer.
- If you are not qualified, do not light pilot lights, perform service, or make adjustments to appliances on the Propane Gas system. If you are qualified, consciously think about the odor of Propane Gas prior to and while lighting pilot lights or performing service or making adjustments.
- Sometimes a basement or a closed-up house has a musty smell that can cover up the Propane Gas odor. Do not try to light pilot lights, perform service, or make adjustments in an area where the conditions are such that you may not detect the odor if there has been a leak of Propane Gas.
- Odor fade, due to oxidation by rust or adsorption on walls of new cylinders and tanks, is possible. Therefore, people should be particularly alert and careful when new tanks or cylinders are placed in service. Odor fade can occur in new tanks, or reinstalled old tanks, if they are filled and allowed to set too long before refilling. Cylinders and tanks which have been out of service for a time may develop internal rust which will cause odor fade. If such conditions are suspected to exist, a periodic sniff test of the gas is advisable. **If you have any question about the gas odor, call your Propane Gas Dealer. A periodic sniff test of the Propane Gas is a good safety measure under any condition.**
- If, at any time, you do not smell the Propane Gas odorant and you think you should, assume you have a leak. Then take the same immediate action recommended above for the occasion when you do detect the odorized Propane Gas.
- If you experience a complete "gas out," (the container is under no vapor pressure), turn the tank valve off immediately. If the container valve is left on, the container may draw in some air through openings such as pilot light orifices. If this occurs, some new internal rusting could occur. If the valve is left open, then treat the container as a new tank. Always be sure your container is under vapor pressure by turning it off at the container before it goes completely empty or having it refilled before it is completely empty.

REQUIREMENTS FOR MASSACHUSETTS

For all side wall horizontally vented gas fueled equipment installed in every dwelling, building or structure used in whole or in part for residential purposes, including those owned or operated by the Commonwealth and where the side wall exhaust vent termination is less than seven feet above finished grade in the area of the venting, including but not limited to decks and porches, the following requirements shall be satisfied:

1. **INSTALLATION OF CARBON MONOXIDE DETECTORS.** At the time of installation of the side wall horizontal vented gas fueled equipment, the installing plumber or gasfitter shall observe that a hard wired carbon monoxide detector with an alarm and battery back-up is installed on the floor level where the gas equipment is to be installed. In addition, the installing plumber or gasfitter shall observe that a battery operated or hard wired carbon monoxide detector with an alarm is installed on each additional level of the dwelling, building or structure served by the side wall horizontal vented gas fueled equipment. It shall be the responsibility of the property owner to secure the services of qualified licensed professionals for the installation of hard wired carbon monoxide detectors.
 - a. In the event that the side wall horizontally vented gas fueled equipment is installed in a crawl space or an attic, the hard wired carbon monoxide detector with alarm and battery back-up may be installed on the next adjacent floor level.
 - b. In the event that the requirements of this subdivision can not be met at the time of completion of installation, the owner shall have a period of thirty days to comply with the above requirements; provided, however, that during said thirty day period, a battery operated carbon monoxide detector with an alarm shall be installed.
2. **APPROVED CARBON MONOXIDE DETECTORS.** Each carbon monoxide detector as required in accordance with the above provisions shall comply with NFPA 720 and be ANSI/UL 2034 listed and IAS certified.
3. **SIGNAGE.** A metal or plastic identification plate shall be permanently mounted to the exterior of the building at a minimum height of eight feet above grade directly in line with the exhaust vent terminal for the horizontally vented gas fueled heating fireplace or equipment. The sign shall read, in print size no less than 1/2 inch in size, **"GAS VENT DIRECTLY BELOW. KEEP CLEAR OF ALL OBSTRUCTIONS"**.
4. **INSPECTION.** The state or local gas inspector of the side wall horizontally vented gas fueled equipment shall not approve the installation unless, upon inspection, the inspector observes carbon monoxide detectors and signage installed in accordance with the provisions of 248 CMR 5.08(2)(a) 1 through 4.
 - (b) **EXEMPTIONS:** The following equipment is exempt from 248 CMR 5.08(2)(a)1 through 4:
 1. The equipment listed in Chapter 10 entitled "Equipment Not Required To Be Vented" in the most current edition of NFPA 54 as adopted by the Board; and
 2. Product Approved side wall horizontally vented gas fueled equipment installed in a room or structure separate from the dwelling, building or structure used in whole or in part for residential purposes.
 - (d) **MANUFACTURER REQUIREMENTS - GAS EQUIPMENT VENTING SYSTEM NOT PROVIDED.** When the manufacturer of a Product Approved side wall horizontally vented gas fueled equipment does not provide the parts for venting the flue gases, but identifies "special venting systems", the following requirements shall be satisfied by the manufacturer:
 1. The referenced "special venting system" instructions shall be included with the fireplace or equipment installation instructions; and
 2. The "special venting systems" shall be Product Approved by the Board, and the instructions for that system shall include a parts list and detailed installation instruction.
 - (e) A copy of all installation instructions for all Product Approved side wall horizontally vented gas fueled equipment, all venting instructions, all parts lists for venting instructions, and/or all venting design instructions shall remain with the fireplace or equipment at the completion of the installation.

WARRANTY

Empire Comfort Systems Inc. warrants this hearth product to be free from defects at the time of purchase and for the periods specified below. Hearth products must be installed by a qualified technician and must be maintained and operated safely, in accordance with the instructions in the owner's manual. This warranty applies to the original purchaser only and is not transferable. All warranty repairs must be accomplished by a qualified gas appliance technician.

Limited Lifetime Parts Warranty – Combustion Chamber, Heat Exchanger, and Factory-Installed Glass

If the combustion chamber, heat exchanger (see parts list) or factory-installed glass fails because of defective workmanship or material, Empire will repair or replace at Empire's option.

Limited Three-Year Parts Warranty – All Other Components

(Except Remote Controls, Thermostats, Accessories and Replacement Parts)

Should any part fail because of defective workmanship or material within three years from the date of purchase, Empire will repair or replace at Empire's option..

Limited One-Year Parts Warranty – Remote Controls, Thermostats, Lighting System, Accessories, and Parts

Should any remote control, thermostat, lighting system, accessory, or other part fail because of defective workmanship within one year from the date of purchase, Empire will repair or replace at Empire's option.

Duties of the Owner

The appliance must be installed by a qualified installer and operated in accordance with the instructions furnished with the appliance.

A bill of sale, canceled check, or payment record should be kept to verify purchase date and establish warranty period.

Ready access to the appliance for service.

What Is Not Covered

Damages that might result from the use, misuse, or improper installation of this appliance.

Travel, diagnostic costs and freight charges on warranted parts to and from the factory.

Claims that do not involve defective workmanship or materials.

Unauthorized service or parts replacements.

Removal and reinstallation cost.

Inoperable due to improper or lack of maintenance.

How To Get Service

To make a claim under this warranty, please have your receipt available and contact your installing dealer. Provide the dealer with the model number, serial number, type of gas, and purchase verification. The installing dealer is responsible for providing service and will contact the factory to initiate any warranted parts replacements. Empire will make replacement parts available at the factory. Shipping expenses are not covered.

If, after contacting your Empire dealer, service received has not been satisfactory, contact: Consumer Relations Department, Empire Comfort Systems Inc., PO Box 529, Belleville, Illinois 62222, or send an e-mail to info@empirecomfort.com with "Consumer Relations" in the subject line.

Your Rights Under State Law

This warranty gives you specific legal rights, and you may also have other rights, which vary from state to state.



SINCE 1932

**Empire Comfort Systems Inc.
Belleville, IL**

If you have a general question about our products, please e-mail us at info@empirecomfort.com.

If you have a service or repair question, please contact your dealer.

www.empirecomfort.com