



Flexible stainless steel relining  
for masonry chimney.  
UL 1777 and ULC S635.

DuraFlex®

DuraVent®

Leaders in-Venting Innovation™

---

## Specifications

### DuraFlex Pro

#### Applications

**DuraFlex Pro** ultra flexible relining for masonry chimney. Use with gas, wood pellet, oil, or wood appliances. Applications include: fireplace inserts, furnaces, boilers, and water heaters.

#### Materials and Construction

Single-wall .005" 316 stainless steel.

#### Clearances

0" clearance for gas, oil, and pellet applications. 1" clearance to masonry for wood-burning applications. Insulation is required for 0" clearance to masonry for wood-burning.

#### Diameters

3"-12".

#### Listings

Listed to UL 1777 and ULC S635 (MH45609).

### DuraFlex SW

#### Applications

**DuraFlex SW** smooth wall flexible relining for masonry chimney. Use with gas, wood pellet, oil, or wood appliances. Applications include: fireplace inserts, furnaces, boilers, and water heaters.

#### Materials and Construction

Single-wall .005" overlapped 316 stainless steel (totalling .010"). Overlapped to create smooth inner wall.

#### Clearances

0" clearance for gas, oil, and pellet applications. 1" clearance to masonry for wood-burning applications. Insulation is required for 0" clearance to masonry for wood-burning.

#### Diameters

3"-12".

#### Listings

Listed to UL 1777 (MH45609).

## UL 1777 and ULC S635 Systems

### DuraFlex Pro

DuraFlex Pro is the ultimate in flexible steel liners for strength and flexibility. It features 20% more stainless steel per foot compared to other liners on the market. Its extreme flexibility facilitates problem free installations where multiple offsets are needed. DuraFlex Pro is available in 3" through 12" diameters in lengths, kits and custom lengths. DuraFlex Pro is manufactured utilizing highly corrosion resistant 316 Stainless Steel. Listed to UL 1777 and ULC S635.

### DuraFlex SW

DuraFlex SW is a smooth inner-wall, flexible stainless steel chimney liner. The smooth inner wall provides for no output reduction allowing for full appliance efficiency. Smooth wall construction eliminates ridges that restrict flue gas flow and collect deposits. The lack of ridges facilitates cleaning and maintenance. DuraFlex SW is ideal for relining masonry chimney for wood and gas burning appliances. Listed to UL 1777.

### Customize The Flex You Need.

All DuraFlex is available for orders requiring custom lengths (minimum 10' length). DuraFlex Pro and DuraFlex SW also offer 9"-12" diameters when ordered in custom lengths. (minimum 10' length). Use Ventinox components for all 9"-12" flex systems.



---

## UL 1777 and ULC S635 Systems

### DuraFlex 316 & 304

DuraFlex 304 and 316 are lighter, more economical liners. Excellent when there are minimal offsets in the chimney. DuraFlex 304SS and 316SS are intended for wood burning, non-condensing gas and oil fired appliances. Where greater corrosion resistance is desired, such as coal-fired appliances, DuraFlex 316 is recommended. DuraFlex 304SS and 316SS are listed to UL 1777 and ULC S635.

### Insulation for Flex

All DuraFlex products must be insulated to meet UL 1777 requirements. See the end of the DuraFlex SS for the insulation section to find information on our offering: TherMix, ProFoil, AluFoil Tape, and ProMesh.

### A Flexible Solution For Any Installation.

Having a choice when making a decision is important. DuraVent offers the installer a range of products to make the right decision for the right situation. There are four different DuraFlex liners, and a complete selection of DuraFlex universal components. No matter which flex is right for the situation, there's a DuraVent component to complete the venting system.



## Specifications

### DuraFlex 316 & 304

#### Applications

**DuraFlex 316** flexible relining for masonry chimney. Use with gas, wood pellet, oil, or wood appliance. Applications include: fireplace inserts, furnaces, boilers, and water heaters. 316 is designed for use in harsher conditions, for more resistance to corrosion, such as coal.

**DuraFlex 304** flexible relining for masonry chimney. Use with gas, wood pellet, oil, or wood appliances. Applications include: fireplace inserts, furnaces, boilers, and water heaters.

#### Materials and Construction

Single-wall .005" 316 or 304 stainless steel.

#### Clearances

0" clearance for gas, oil, and pellet applications. 1" clearance to masonry for wood-burning applications. Insulation is required for 0" clearance to masonry for wood-burning.

#### Diameters

3"-8".

#### Listings

Listed to UL 1777 and ULC S635 (MH45609).

## Typical Installations

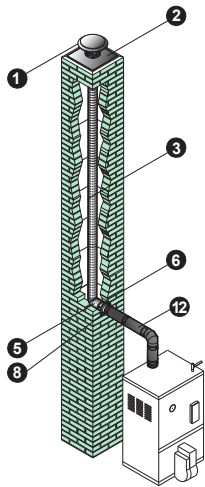

Oil Furnace  
DuraFlex SS

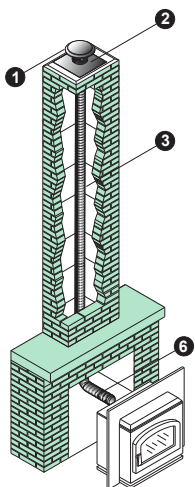

Pellet Insert  
DuraFlex SS

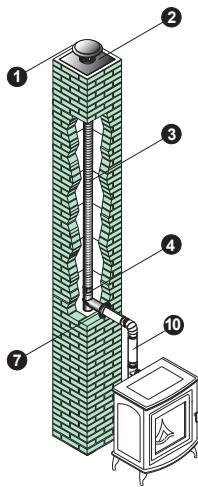

Pellet Stove  
DuraFlex SS & PelletVent Pro

### Installation Key

|   |  |    |  |
|---|--|----|--|
| 1 | DuraFlex SS Removable Vertical Cap       | 8  | DuraBlack Trim Collar                      |
| 2 | DuraFlex Top Plate w/welded Storm Collar | 9  | Rigid Type B Gas Vent                      |
| 3 | DuraFlex (SW, Pro, 304, 316) Length      | 10 | Rigid PelletVent (L Vent)                  |
| 4 | DuraFlex SS Tee                          | 11 | ProFoil Insulation, AluFoil Tape & ProMesh |
| 5 | DuraFlex Mortar Sleeve                   | 12 | DVL or DuraBlack Pipe                      |
| 6 | DuraFlex SS Connector                    | 13 | Pipe Collar (B-Vent)                       |
| 7 | PelletVent Pro Appliance Adapter         |    |  |

Refer to our Typical Venting Installation drawings to select the appropriate component parts for your installation.

- The inner pipe diameter should match the outlet size of the appliance.
- Check the appliance manufacturer's installation instructions to confirm which types of vent configurations are permitted (i.e. horizontal, vertical, chimney reline, etc.). Also, check for any venting restrictions such as maximum horizontal run, minimum and maximum vertical rise, maximum offset, etc.
- Be fire safe! Use proper support and bracing. Follow local building codes and have your venting system inspected.

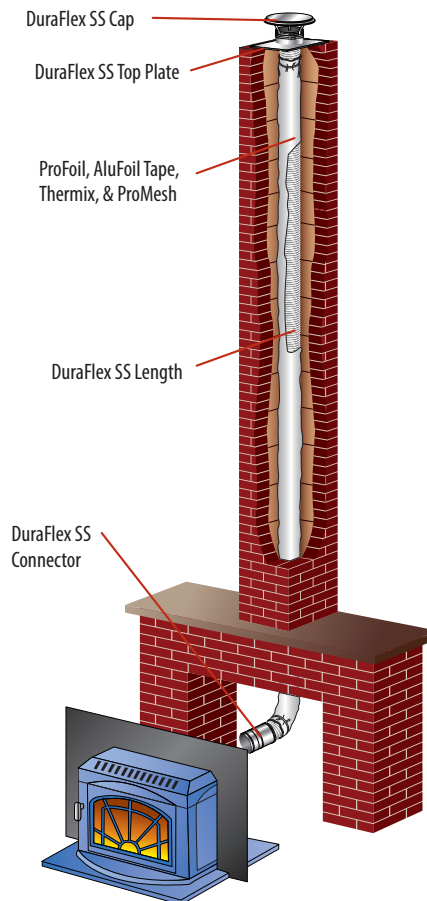

## Planning Your Installation

|   |   |
|---|---|
| 1 | Verify the venting requirements of the appliance used. Choose the liner system appropriate for the appliance and installation.  |
| 2 | Refer to the Typical Installations for the type of liner installation similar to your situation. Identify the needed parts for installation.  |
| 3 | The size of the liner should match the outlet size on the appliance or the size of the vent/manifold that penetrates into the masonry chimney.  |
| 4 | Determine the length of liner needed.   |
| 5 | Make sure of a proper fit for the Top Plate of the reliner to provide a secure, leak-proof installation.  |
| 6 | If a free-standing appliance is used, select the vent or stovepipe pieces to connect from the appliance to the liner (refer to the appropriate section of catalog).                                     |
| 7 | Important! Check to be sure the installation complies with all local and national code requirements, including clearance to combustibles. Contact the local building inspector for permit requirements. |

## Design Recommendations

- The following design recommendations are intended only as a general guideline to assist in the design and selection of liner components for your installation. Always read and follow DuraVent Installation instructions (enclosed with the cap or support box) before installing DuraFlex. Installation instructions can be viewed online at [www.duravent.com](http://www.duravent.com), under catalogs and instructions.
- Before relining a chimney, it should be cleaned and inspected to verify the integrity of the mortar and masonry. In addition, have a certified chimney professional determine if the masonry was constructed with 0" or 1" clearance to the surrounding combustibles. This is an important fire safety issue that may have an influence on how the liner is installed.
- Be sure to select the proper liner for the application. DuraFlex SS is used for appliances that use oil, wood, or wood-pellets for fuel; DuraFlex AL is for a non-condensing gas appliance. Refer to the appliance manufacturer for installation requirements affecting venting. Keep the vent path as straight as possible for best performance.

### Factory-Built Reline Kit

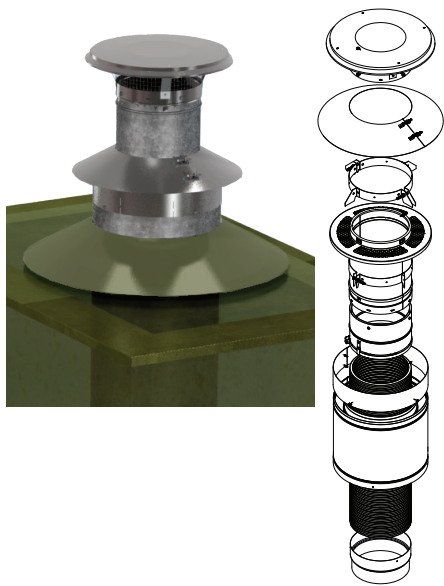

Use as a relining system for factory-built chimneys to be used with solid-fuel appliances in the USA. Relining is critical for performance and safety when a wood-burning insert is installed into an existing UL-127-listed fireplace.

Kit includes: Cap, Storm Collar, Support Bracket, Ventilation Disk, Centering Bracket, DuraLiner 12" Length, Flex Connector, Flex Length (25' or 35'), Adjustable Band, and Flex Adapter.

Minimum 8" chimney inner, maximum 14" outer.

| SIZE |              | 25' FLEX     |           | 35' FLEX     |           |
|------|--------------|--------------|-----------|--------------|-----------|
|      |              | ORDER #      | STOCK #   | ORDER #      | STOCK #   |
| 6"   | DuraFlex Pro | 6DFPRO-25KFB | 810007149 | 6DFPRO-35KFB | 810007150 |
|      | DuraFlex 304 | 6DF304-25KFB | 810007151 | 6DF304-35KFB | 810007152 |
|      | DuraFlex 316 | 6DF316-25KFB | 810007153 | 6DF316-35KFB | 810007154 |

### DuraFlex SW Basic Kit



Kit includes: DuraFlex SS Top Plate w/welded Storm Collar, DuraFlex SS Removable Vertical Cap, DuraFlex SS Connector, and DuraFlex SW length. Flex lengths available in 15', 20', 25', 30', and 35'.

| SIZE   | 15' FLEX   |           | 20' FLEX   |           | 25' FLEX   |           |
|--------|------------|-----------|------------|-----------|------------|-----------|
|        | ORDER #    | STOCK #   | ORDER #    | STOCK #   | ORDER #    | STOCK #   |
| 3"     | 3DFSW-15K  | 810002293 | 3DFSW-20K  | 810002294 | 3DFSW-25K  | 810002295 |
| 4"     | 4DFSW-15K  | 810002298 | 4DFSW-20K  | 810002299 | 4DFSW-25K  | 810002300 |
| 5"     | 5DFSW-15K  | 810002303 | 5DFSW-20K  | 810002304 | 5DFSW-25K  | 810002305 |
| 5 1/2" | 55DFSW-15K | 810002308 | 55DFSW-20K | 810002309 | 55DFSW-25K | 810002310 |
| 6"     | 6DFSW-15K  | 810002313 | 6DFSW-20K  | 810002314 | 6DFSW-25K  | 810002315 |
| 7"     | 7DFSW-15K  | 810002318 | 7DFSW-20K  | 810002319 | 7DFSW-25K  | 810002320 |
| 8"     | 8DFSW-15K  | 810002323 | 8DFSW-20K  | 810002324 | 8DFSW-25K  | 810002325 |
| SIZE   | 30' FLEX   |           | 35' FLEX   |           |            |           |
|        | ORDER #    | STOCK #   | ORDER #    | STOCK #   |            |           |
| 3"     | 3DFSW-30K  | 810002296 | 3DFSW-35K  | 810002297 |            |           |
| 4"     | 4DFSW-30K  | 810002301 | 4DFSW-35K  | 810002302 |            |           |
| 5"     | 5DFSW-30K  | 810002306 | 5DFSW-35K  | 810002307 |            |           |
| 5 1/2" | 55DFSW-30K | 810002311 | 55DFSW-35K | 810002312 |            |           |
| 6"     | 6DFSW-30K  | 810002316 | 6DFSW-35K  | 810002317 |            |           |
| 7"     | 7DFSW-30K  | 810002321 | 7DFSW-35K  | 810002322 |            |           |
| 8"     | 8DFSW-30K  | 810002326 | 8DFSW-35K  | 810002327 |            |           |

## DuraFlex SW Tee Kit



Kit includes: DuraFlex SS Top Plate w/welded Storm Collar, DuraFlex SS Removable Vertical Cap, DuraFlex SS Tee with Cap, and DuraFlex SW length. Kit flex lengths available in 15', 20', 25', 30', and 35'.

| SIZE   | 15' FLEX    |           | 20' FLEX    |           | 25' FLEX    |           |
|--------|-------------|-----------|-------------|-----------|-------------|-----------|
|        | ORDER #     | STOCK #   | ORDER #     | STOCK #   | ORDER #     | STOCK #   |
| 3"     | 3DFSW-15KT  | 810002328 | 3DFSW-20KT  | 810002329 | 3DFSW-25KT  | 810002330 |
| 4"     | 4DFSW-15KT  | 810002333 | 4DFSW-20KT  | 810002334 | 4DFSW-25KT  | 810002335 |
| 5"     | 5DFSW-15KT  | 810002338 | 5DFSW-20KT  | 810002339 | 5DFSW-25KT  | 810002340 |
| 5 1/2" | 55DFSW-15KT | 810002343 | 55DFSW-20KT | 810002344 | 55DFSW-25KT | 810002345 |
| 6"     | 6DFSW-15KT  | 810002348 | 6DFSW-20KT  | 810002349 | 6DFSW-25KT  | 810002350 |
| 7"     | 7DFSW-15KT  | 810002353 | 7DFSW-20KT  | 810002354 | 7DFSW-25KT  | 810002355 |
| 8"     | 8DFSW-15KT  | 810002358 | 8DFSW-20KT  | 810002359 | 8DFSW-25KT  | 810002360 |
| SIZE   | 30' FLEX    |           | 35' FLEX    |           |             |           |
|        | ORDER #     | STOCK #   | ORDER #     | STOCK #   |             |           |
| 3"     | 3DFSW-30KT  | 810002331 | 3DFSW-35KT  | 810002332 |             |           |
| 4"     | 4DFSW-30KT  | 810002336 | 4DFSW-35KT  | 810002337 |             |           |
| 5"     | 5DFSW-30KT  | 810002341 | 5DFSW-35KT  | 810002342 |             |           |
| 5 1/2" | 55DFSW-30KT | 810002346 | 55DFSW-35KT | 810002347 |             |           |
| 6"     | 6DFSW-30KT  | 810002351 | 6DFSW-35KT  | 810002352 |             |           |
| 7"     | 7DFSW-30KT  | 810002356 | 7DFSW-35KT  | 810002357 |             |           |
| 8"     | 8DFSW-30KT  | 810002361 | 8DFSW-35KT  | 810002362 |             |           |

## DuraFlex SW Stainless Steel Length



Custom lengths also available for 3" - 8" diameters. 9"-12" diameters available in custom lengths only (Use Ventinox components). Minimum length of 10' for custom orders. Maximum 200' for 3" - 4" diameters, 125' for 5" diameter, 100' for 5.5" - 6", 50' for 7" - 8", 25' for 10" and 12" diameters. Must be ordered in increments of 10'.

3"-8" diameter flex can be ovalized up to the first 4'. Call Customer Service to add ovalizing to your order and for pricing.

| SIZE   | 15' FLEX   |           | 20' FLEX  |           | 25' FLEX  |           |
|--------|------------|-----------|-----------|-----------|-----------|-----------|
|        | ORDER #    | STOCK #   | ORDER #   | STOCK #   | ORDER #   | STOCK #   |
| 3"     | 3DFSW-15   | 810002374 | 3DFSW-20  | 810002375 | 3DFSW-25  | 810002376 |
| 4"     | 4DFSW-15   | 810002381 | 4DFSW-20  | 810002382 | 4DFSW-25  | 810002383 |
| 5"     | 5DFSW-15   | 810002388 | 5DFSW-20  | 810002389 | 5DFSW-25  | 810002390 |
| 5 1/2" | 55DFSW-15  | 810002395 | 55DFSW-20 | 810002396 | 55DFSW-25 | 810002397 |
| 6"     | 6DFSW-15   | 810002402 | 6DFSW-20  | 810002403 | 6DFSW-25  | 810002404 |
| 7"     | 7DFSW-15   | 810002409 | 7DFSW-20  | 810002410 | 7DFSW-25  | 810002411 |
| 8"     | 8DFSW-15   | 810002415 | 8DFSW-20  | 810002416 | 8DFSW-25  | 810002417 |
| SIZE   | 30' FLEX   |           | 35' FLEX  |           | 50' FLEX  |           |
|        | ORDER #    | STOCK #   | ORDER #   | STOCK #   | ORDER #   | STOCK #   |
| 3"     | 3DFSW-30   | 810002377 | 3DFSW-35  | 810002378 | 3DFSW-50  | 810002379 |
| 4"     | 4DFSW-30   | 810002384 | 4DFSW-35  | 810002385 | 4DFSW-50  | 810002386 |
| 5"     | 5DFSW-30   | 810002391 | 5DFSW-35  | 810002392 | 5DFSW-50  | 810002393 |
| 5 1/2" | 55DFSW-30  | 810002398 | 55DFSW-35 | 810002399 | 55DFSW-50 | 810002400 |
| 6"     | 6DFSW-30   | 810002405 | 6DFSW-35  | 810002406 | 6DFSW-50  | 810002407 |
| 7"     | 7DFSW-30   | 810002412 | 7DFSW-35  | 810002413 | 7DFSW-50  | 810002414 |
| 8"     | 8DFSW-30   | 810002418 | 8DFSW-35  | 810002419 | 8DFSW-50  | 810002420 |
| SIZE   | 100' FLEX  |           | 125' FLEX |           | 200' FLEX |           |
|        | ORDER #    | STOCK #   | ORDER #   | STOCK #   | ORDER #   | STOCK #   |
| 3"     | --         | --        | --        | --        | 3DFSW-200 | 810002380 |
| 4"     | --         | --        | --        | --        | 4DFSW-200 | 810002387 |
| 5"     | --         | --        | 5DFSW-125 | 810002394 | --        | --        |
| 5 1/2" | 55DFSW-100 | 810002401 | --        | --        | --        | --        |
| 6"     | 6DFSW-100  | 810002408 | --        | --        | --        | --        |



### DuraFlex Pro Basic Kit



Kit includes: DuraFlex SS Top Plate w/welded Storm Collar, DuraFlex SS Removable Vertical Cap, DuraFlex SS Connector, and DuraFlex Pro length. Kit flex lengths available in 15', 20', 25', 30', and 35'.

| SIZE   | 15' FLEX    |           | 20' FLEX    |           | 25' FLEX    |           |
|--------|-------------|-----------|-------------|-----------|-------------|-----------|
|        | ORDER #     | STOCK #   | ORDER #     | STOCK #   | ORDER #     | STOCK #   |
| 3"     | 3DFPRO-15K  | 810002151 | 3DFPRO-20K  | 810002152 | 3DFPRO-25K  | 810002153 |
| 4"     | 4DFPRO-15K  | 810002156 | 4DFPRO-20K  | 810002157 | 4DFPRO-25K  | 810002158 |
| 5"     | 5DFPRO-15K  | 810002161 | 5DFPRO-20K  | 810002162 | 5DFPRO-25K  | 810002163 |
| 5 1/2" | 55DFPRO-15K | 810002166 | 55DFPRO-20K | 810002167 | 55DFPRO-25K | 810002168 |
| 6"     | 6DFPRO-15K  | 810002171 | 6DFPRO-20K  | 810002172 | 6DFPRO-25K  | 810002173 |
| 7"     | 7DFPRO-15K  | 810002176 | 7DFPRO-20K  | 810002177 | 7DFPRO-25K  | 810002178 |
| 8"     | 8DFPRO-15K  | 810002181 | 8DFPRO-20K  | 810002182 | 8DFPRO-25K  | 810002183 |
| SIZE   | 30' FLEX    |           | 35' FLEX    |           |             |           |
|        | ORDER #     | STOCK #   | ORDER #     | STOCK #   |             |           |
| 3"     | 3DFPRO-30K  | 810002154 | 3DFPRO-35K  | 810002155 |             |           |
| 4"     | 4DFPRO-30K  | 810002159 | 4DFPRO-35K  | 810002160 |             |           |
| 5"     | 5DFPRO-30K  | 810002164 | 5DFPRO-35K  | 810002165 |             |           |
| 5 1/2" | 55DFPRO-30K | 810002169 | 55DFPRO-35K | 810002170 |             |           |
| 6"     | 6DFPRO-30K  | 810002174 | 6DFPRO-35K  | 810002175 |             |           |
| 7"     | 7DFPRO-30K  | 810002179 | 7DFPRO-35K  | 810002180 |             |           |
| 8"     | 8DFPRO-30K  | 810002184 | 8DFPRO-35K  | 810002185 |             |           |

### DuraFlex Pro Tee Kit



Kit includes: DuraFlex SS Top Plate w/welded Storm Collar, DuraFlex SS Removable Vertical Cap, DuraFlex SS Tee with Cap, and DuraFlex Pro length. Kit flex lengths available in 15', 20', 25', 30', and 35'.

| SIZE   | 15' FLEX     |           | 20' FLEX     |           | 25' FLEX     |           |
|--------|--------------|-----------|--------------|-----------|--------------|-----------|
|        | ORDER #      | STOCK #   | ORDER #      | STOCK #   | ORDER #      | STOCK #   |
| 3"     | 3DFPRO-15KT  | 810002186 | 3DFPRO-20KT  | 810002187 | 3DFPRO-25KT  | 810002188 |
| 4"     | 4DFPRO-15KT  | 810002191 | 4DFPRO-20KT  | 810002192 | 4DFPRO-25KT  | 810002193 |
| 5"     | 5DFPRO-15KT  | 810002196 | 5DFPRO-20KT  | 810002197 | 5DFPRO-25KT  | 810002198 |
| 5 1/2" | 55DFPRO-15KT | 810002201 | 55DFPRO-20KT | 810002202 | 55DFPRO-25KT | 810002203 |
| 6"     | 6DFPRO-15KT  | 810002206 | 6DFPRO-20KT  | 810002207 | 6DFPRO-25KT  | 810002208 |
| 7"     | 7DFPRO-15KT  | 810002211 | 7DFPRO-20KT  | 810002212 | 7DFPRO-25KT  | 810002213 |
| 8"     | 8DFPRO-15KT  | 810002216 | 8DFPRO-20KT  | 810002217 | 8DFPRO-25KT  | 810002218 |
| SIZE   | 30' FLEX     |           | 35' FLEX     |           |              |           |
|        | ORDER #      | STOCK #   | ORDER #      | STOCK #   |              |           |
| 3"     | 3DFPRO-30KT  | 810002189 | 3DFPRO-35KT  | 810002190 |              |           |
| 4"     | 4DFPRO-30KT  | 810002194 | 4DFPRO-35KT  | 810002195 |              |           |
| 5"     | 5DFPRO-30KT  | 810002199 | 5DFPRO-35KT  | 810002200 |              |           |
| 5 1/2" | 55DFPRO-30KT | 810002204 | 55DFPRO-35KT | 810002205 |              |           |
| 6"     | 6DFPRO-30KT  | 810002209 | 6DFPRO-35KT  | 810002210 |              |           |
| 7"     | 7DFPRO-30KT  | 810002214 | 7DFPRO-35KT  | 810002215 |              |           |
| 8"     | 8DFPRO-30KT  | 810002219 | 8DFPRO-35KT  | 810002220 |              |           |

### DuraFlex Pro Top Plate/Cap Kit



Kit includes: DuraFlex SS Top Plate w/welded Storm Collar, DuraFlex SS Removable Vertical Cap, plus DuraFlex SS Connector, and DuraFlex Pro length. Flex remains secured to the Storm Collar/Top Plate when removing the cap section for inspections and cleaning.

| SIZE   | 20' FLEX      |           | 25' FLEX      |           |
|--------|---------------|-----------|---------------|-----------|
|        | ORDER #       | STOCK #   | ORDER #       | STOCK #   |
| 3"     | 3DFPRO-20VCK  | 810002221 | 3DFPRO-25VCK  | 810006967 |
| 4"     | 4DFPRO-20VCK  | 810002222 | 4DFPRO-25VCK  | 810002223 |
| 5"     | --            | --        | 5DFPRO-25VCK  | 810006969 |
| 5 1/2" | 55DFPRO-20VCK | 810002226 | 55DFPRO-25VCK | 810002227 |
| 6"     | --            | --        | 6DFPRO-25VCK  | 810002230 |
| 7"     | --            | --        | 7DFPRO-25VCK  | 810006971 |
| 8"     | --            | --        | 8DFPRO-25VCK  | 810006973 |
| SIZE   | 30' FLEX      |           | 35' FLEX      |           |
|        | ORDER #       | STOCK #   | ORDER #       | STOCK #   |
| 3"     | --            | --        | 3DFPRO-35VCK  | 810006968 |
| 4"     | 4DFPRO-30VCK  | 810002224 | 4DFPRO-35VCK  | 810002225 |
| 5"     | --            | --        | 5DFPRO-35VCK  | 810006970 |
| 5 1/2" | 55DFPRO-30VCK | 810002228 | 55DFPRO-35VCK | 810002229 |
| 6"     | 6DFPRO-30VCK  | 810002231 | 6DFPRO-35VCK  | 810002232 |
| 7"     | --            | --        | 7DFPRO-35VCK  | 810006972 |
| 8"     | --            | --        | 8DFPRO-35VCK  | 810006974 |

### DuraFlex Pro Ovalized Top Plate/Cap Kit



Kit includes: DuraFlex SS Top Plate w/welded Storm Collar, DuraFlex SS Removable Vertical Cap, Oval to Round Insert Adapter with Clamp, and DuraFlex Pro length with the first 4 feet ovalized. Flex remains secured to the Storm Collar/Top Plate when removing the cap section for inspections and cleaning.

| SIZE | 25' FLEX         |           | 35' FLEX         |           |
|------|------------------|-----------|------------------|-----------|
|      | ORDER #          | STOCK #   | ORDER #          | STOCK #   |
| 6"   | 6DFPRO-25OVALVCK | 810002233 | 6DFPRO-35OVALVCK | 810002234 |

## DuraFlex Pro Stainless Steel Length



Custom lengths also available for 3" - 8" diameters. 9"-12" diameters available in custom lengths only (Use Ventinox components). Minimum length of 10' for custom orders. Maximum 200' for 3" - 4" diameters, 125' for 5" diameter, 100' for 5.5" - 6", 50' for 7" - 8", 25' for 10" and 12" diameters. Must be ordered in increments of 10'.

3"-8" diameter flex can be ovalized up to the first 4'. Call Customer Service to add ovalizing to your order and for pricing.

| SIZE   | 15' FLEX    |           | 20' FLEX   |           | 25' FLEX   |           |
|--------|-------------|-----------|------------|-----------|------------|-----------|
|        | ORDER #     | STOCK #   | ORDER #    | STOCK #   | ORDER #    | STOCK #   |
| 3"     | 3DFPRO-15   | 810002246 | 3DFPRO-20  | 810002247 | 3DFPRO-25  | 810002248 |
| 4"     | 4DFPRO-15   | 810002253 | 4DFPRO-20  | 810002254 | 4DFPRO-25  | 810002255 |
| 5"     | 5DFPRO-15   | 810002260 | 5DFPRO-20  | 810002261 | 5DFPRO-25  | 810002262 |
| 5 1/2" | 55DFPRO-15  | 810002267 | 55DFPRO-20 | 810002268 | 55DFPRO-25 | 810002269 |
| 6"     | 6DFPRO-15   | 810002274 | 6DFPRO-20  | 810002275 | 6DFPRO-25  | 810006161 |
| 7"     | 7DFPRO-15   | 810002281 | 7DFPRO-20  | 810002282 | 7DFPRO-25  | 810002283 |
| 8"     | 8DFPRO-15   | 810002287 | 8DFPRO-20  | 810002288 | 8DFPRO-25  | 810002289 |
| SIZE   | 30' FLEX    |           | 35' FLEX   |           | 50' FLEX   |           |
|        | ORDER #     | STOCK #   | ORDER #    | STOCK #   | ORDER #    | STOCK #   |
| 3"     | 3DFPRO-30   | 810002249 | 3DFPRO-35  | 810002250 | 3DFPRO-50  | 810002251 |
| 4"     | 4DFPRO-30   | 810002256 | 4DFPRO-35  | 810002257 | 4DFPRO-50  | 810002258 |
| 5"     | 5DFPRO-30   | 810002263 | 5DFPRO-35  | 810002264 | 5DFPRO-50  | 810002265 |
| 5 1/2" | 55DFPRO-30  | 810002270 | 55DFPRO-35 | 810002271 | 55DFPRO-50 | 810002272 |
| 6"     | 6DFPRO-30   | 810002277 | 6DFPRO-35  | 810002278 | 6DFPRO-50  | 810006164 |
| 7"     | 7DFPRO-30   | 810002284 | 7DFPRO-35  | 810002285 | 7DFPRO-50  | 810002286 |
| 8"     | 8DFPRO-30   | 810002290 | 8DFPRO-35  | 810002291 | 8DFPRO-50  | 810002292 |
| SIZE   | 100' FLEX   |           | 125' FLEX  |           | 200' FLEX  |           |
|        | ORDER #     | STOCK #   | ORDER #    | STOCK #   | ORDER #    | STOCK #   |
| 3"     | --          | --        | --         | --        | 3DFPRO-200 | 810002252 |
| 4"     | --          | --        | --         | --        | 4DFPRO-200 | 810002259 |
| 5"     | --          | --        | 5DFPRO-125 | 810002266 | --         | --        |
| 5 1/2" | 55DFPRO-100 | 810002273 | --         | --        | --         | --        |
| 6"     | 6DFPRO-100  | 810002280 | --         | --        | --         | --        |

### DuraFlex 316 Basic Kit



Kit includes: DuraFlex SS Top Plate w/welded Storm Collar, DuraFlex SS Removable Vertical Cap, DuraFlex SS Connector, and DuraFlex 316 length. Kit flex lengths available in 15', 20', 25', 30', and 35'.

| SIZE   | 15' FLEX    |           | 20' FLEX    |           | 25' FLEX    |           |
|--------|-------------|-----------|-------------|-----------|-------------|-----------|
|        | ORDER #     | STOCK #   | ORDER #     | STOCK #   | ORDER #     | STOCK #   |
| 3"     | 3DF316-15K  | 810002026 | 3DF316-20K  | 810002027 | 3DF316-25K  | 810002028 |
| 4"     | 4DF316-15K  | 810002031 | 4DF316-20K  | 810002032 | 4DF316-25K  | 810002033 |
| 5"     | 5DF316-15K  | 810002036 | 5DF316-20K  | 810002037 | 5DF316-25K  | 810002038 |
| 5 1/2" | 55DF316-15K | 810002041 | 55DF316-20K | 810002042 | 55DF316-25K | 810002043 |
| 6"     | 6DF316-15K  | 810002046 | 6DF316-20K  | 810002047 | 6DF316-25K  | 810002048 |
| 7"     | 7DF316-15K  | 810002051 | 7DF316-20K  | 810002052 | 7DF316-25K  | 810002053 |
| 8"     | 8DF316-15K  | 810002056 | 8DF316-20K  | 810002057 | 8DF316-25K  | 810002058 |
| SIZE   | 30' FLEX    |           | 35' FLEX    |           |             |           |
|        | ORDER #     | STOCK #   | ORDER #     | STOCK #   |             |           |
| 3"     | 3DF316-30K  | 810002029 | 3DF316-35K  | 810002030 |             |           |
| 4"     | 4DF316-30K  | 810002034 | 4DF316-35K  | 810002035 |             |           |
| 5"     | 5DF316-30K  | 810002039 | 5DF316-35K  | 810002040 |             |           |
| 5 1/2" | 55DF316-30K | 810002044 | 55DF316-35K | 810002045 |             |           |
| 6"     | 6DF316-30K  | 810002049 | 6DF316-35K  | 810002050 |             |           |
| 7"     | 7DF316-30K  | 810002054 | 7DF316-35K  | 810002055 |             |           |
| 8"     | 8DF316-30K  | 810002059 | 8DF316-35K  | 810002060 |             |           |

### DuraFlex 316 Tee Kit



Kit includes: DuraFlex SS Top Plate w/welded Storm Collar, DuraFlex SS Removable Vertical Cap, DuraFlex SS Tee with Cap, and DuraFlex 316 length. Kit flex lengths available in 15', 20', 25', 30', and 35'.

| SIZE   | 15' FLEX     |           | 20' FLEX     |           | 25' FLEX     |           |
|--------|--------------|-----------|--------------|-----------|--------------|-----------|
|        | ORDER #      | STOCK #   | ORDER #      | STOCK #   | ORDER #      | STOCK #   |
| 3"     | 3DF316-15KT  | 810002061 | 3DF316-20KT  | 810002062 | 3DF316-25KT  | 810002063 |
| 4"     | 4DF316-15KT  | 810002066 | 4DF316-20KT  | 810002067 | 4DF316-25KT  | 810002068 |
| 5"     | 5DF316-15KT  | 810002071 | 5DF316-20KT  | 810002072 | 5DF316-25KT  | 810002073 |
| 5 1/2" | 55DF316-15KT | 810002076 | 55DF316-20KT | 810002077 | 55DF316-25KT | 810002078 |
| 6"     | 6DF316-15KT  | 810002081 | 6DF316-20KT  | 810002082 | 6DF316-25KT  | 810002083 |
| 7"     | 7DF316-15KT  | 810002086 | 7DF316-20KT  | 810002087 | 7DF316-25KT  | 810002088 |
| 8"     | 8DF316-15KT  | 810002091 | 8DF316-20KT  | 810002092 | 8DF316-25KT  | 810002093 |
| SIZE   | 30' FLEX     |           | 35' FLEX     |           |              |           |
|        | ORDER #      | STOCK #   | ORDER #      | STOCK #   |              |           |
| 3"     | 3DF316-30KT  | 810002064 | 3DF316-35KT  | 810002065 |              |           |
| 4"     | 4DF316-30KT  | 810002069 | 4DF316-35KT  | 810002070 |              |           |
| 5"     | 5DF316-30KT  | 810002074 | 5DF316-35KT  | 810002075 |              |           |
| 5 1/2" | 55DF316-30KT | 810002079 | 55DF316-35KT | 810002080 |              |           |
| 6"     | 6DF316-30KT  | 810002084 | 6DF316-35KT  | 810002085 |              |           |
| 7"     | 7DF316-30KT  | 810002089 | 7DF316-35KT  | 810002090 |              |           |
| 8"     | 8DF316-30KT  | 810002094 | 8DF316-35KT  | 810002095 |              |           |

### DuraFlex 316 Top Plate/Cap Kit



Kit includes: DuraFlex SS Top Plate w/welded Storm Collar, DuraFlex SS Removable Vertical Cap, plus DuraFlex SS Connector, and DuraFlex 316 length. Flex remains secured to the Storm Collar/Top Plate when removing the cap section for inspections and cleaning.

| SIZE   | 25' FLEX      |           | 35' FLEX      |           |
|--------|---------------|-----------|---------------|-----------|
|        | ORDER #       | STOCK #   | ORDER #       | STOCK #   |
| 4"     | 4DF316-25VCK  | 810002096 | 4DF316-35VCK  | 810002097 |
| 5 1/2" | 55DF316-25VCK | 810002098 | 55DF316-35VCK | 810002099 |
| 6"     | 6DF316-25VCK  | 810002100 | 6DF316-35VCK  | 810002101 |

### DuraFlex 316 Stainless Steel Length



Use with wood-pellet, non-condensing gas, wood-burning, and oil appliances. Custom lengths available for 3"-8" diameters. Minimum length of 10' for custom orders. Maximum 100' for 3" - 8". Must be ordered in increments of 10'.

3"-8" diameter flex can be ovalized up to the first 4'. Call Customer Service to add ovalizing to your order and for pricing.

| SIZE   | 15' FLEX    |           | 20' FLEX   |           | 25' FLEX   |           |
|--------|-------------|-----------|------------|-----------|------------|-----------|
|        | ORDER #     | STOCK #   | ORDER #    | STOCK #   | ORDER #    | STOCK #   |
| 3"     | 3DF316-15   | 810002109 | 3DF316-20  | 810002110 | 3DF316-25  | 810002111 |
| 4"     | 4DF316-15   | 810002115 | 4DF316-20  | 810002116 | 4DF316-25  | 810002117 |
| 5"     | 5DF316-15   | 810002121 | 5DF316-20  | 810002122 | 5DF316-25  | 810002123 |
| 5 1/2" | 55DF316-15  | 810002127 | 55DF316-20 | 810002128 | 55DF316-25 | 810002129 |
| 6"     | 6DF316-15   | 810002133 | 6DF316-20  | 810002134 | 6DF316-25  | 810002135 |
| 7"     | 7DF316-15   | 810002139 | 7DF316-20  | 810002140 | 7DF316-25  | 810002141 |
| 8"     | 8DF316-15   | 810002145 | 8DF316-20  | 810002146 | 8DF316-25  | 810002147 |
| SIZE   | 30' FLEX    |           | 35' FLEX   |           | 50' FLEX   |           |
|        | ORDER #     | STOCK #   | ORDER #    | STOCK #   | ORDER #    | STOCK #   |
| 3"     | 3DF316-30   | 810002112 | 3DF316-35  | 810002113 | --         | --        |
| 4"     | 4DF316-30   | 810002118 | 4DF316-35  | 810002119 | --         | --        |
| 5"     | 5DF316-30   | 810002124 | 5DF316-35  | 810002125 | --         | --        |
| 5 1/2" | 55DF316-30  | 810002130 | 55DF316-35 | 810002131 | --         | --        |
| 6"     | 6DF316-30   | 810002136 | 6DF316-35  | 810002137 | --         | --        |
| 7"     | 7DF316-30   | 810002142 | 7DF316-35  | 810002143 | 7DF316-50  | 810002144 |
| 8"     | 8DF316-30   | 810002148 | 8DF316-35  | 810002149 | 8DF316-50  | 810002150 |
| SIZE   | 100' FLEX   |           |            |           |            |           |
|        | ORDER #     | STOCK #   |            |           |            |           |
| 3"     | 3DF316-100  | 810002114 |            |           |            |           |
| 4"     | 4DF316-100  | 810002120 |            |           |            |           |
| 5"     | 5DF316-100  | 810002126 |            |           |            |           |
| 5 1/2" | 55DF316-100 | 810002132 |            |           |            |           |
| 6"     | 6DF316-100  | 810002138 |            |           |            |           |

### DuraFlex 304 Basic Kit



Kit includes: DuraFlex SS Top Plate w/welded Storm Collar, DuraFlex SS Removable Vertical Cap, DuraFlex SS Connector, and DuraFlex 304 length. Kit flex lengths available in 15', 20', 25', 30', and 35'.

| SIZE   | 15' FLEX    |           | 20' FLEX    |           | 25' FLEX    |           |
|--------|-------------|-----------|-------------|-----------|-------------|-----------|
|        | ORDER #     | STOCK #   | ORDER #     | STOCK #   | ORDER #     | STOCK #   |
| 3"     | 3DF304-15K  | 810001907 | 3DF304-20K  | 810001908 | 3DF304-25K  | 810001909 |
| 4"     | 4DF304-15K  | 810001912 | 4DF304-20K  | 810001913 | 4DF304-25K  | 810001914 |
| 5"     | 5DF304-15K  | 810001917 | 5DF304-20K  | 810001918 | 5DF304-25K  | 810001919 |
| 5 1/2" | 55DF304-15K | 810001922 | 55DF304-20K | 810001923 | 55DF304-25K | 810001924 |
| 6"     | 6DF304-15K  | 810001927 | 6DF304-20K  | 810001928 | 6DF304-25K  | 810001929 |
| 7"     | 7DF304-15K  | 810001932 | 7DF304-20K  | 810001933 | 7DF304-25K  | 810001934 |
| 8"     | 8DF304-15K  | 810001937 | 8DF304-20K  | 810001938 | 8DF304-25K  | 810001939 |
| SIZE   | 30' FLEX    |           | 35' FLEX    |           |             |           |
|        | ORDER #     | STOCK #   | ORDER #     | STOCK #   |             |           |
| 3"     | 3DF304-30K  | 810001910 | 3DF304-35K  | 810001911 |             |           |
| 4"     | 4DF304-30K  | 810001915 | 4DF304-35K  | 810001916 |             |           |
| 5"     | 5DF304-30K  | 810001920 | 5DF304-35K  | 810001921 |             |           |
| 5 1/2" | 55DF304-30K | 810001925 | 55DF304-35K | 810001926 |             |           |
| 6"     | 6DF304-30K  | 810001930 | 6DF304-35K  | 810001931 |             |           |
| 7"     | 7DF304-30K  | 810001935 | 7DF304-35K  | 810001936 |             |           |
| 8"     | 8DF304-30K  | 810001940 | 8DF304-35K  | 810001941 |             |           |

### DuraFlex 304 Tee Kit

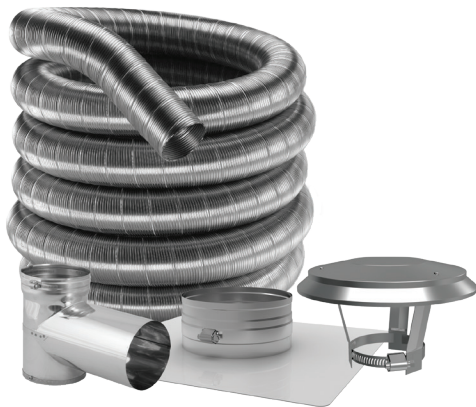

Kit includes: DuraFlex SS Top Plate w/welded Storm Collar, DuraFlex SS Removable Vertical Cap, DuraFlex SS Tee with Cap, and DuraFlex 304 length. Kit flex lengths available in 15', 20', 25', 30', and 35'.

| SIZE   | 15' FLEX     |           | 20' FLEX     |           | 25' FLEX     |           |
|--------|--------------|-----------|--------------|-----------|--------------|-----------|
|        | ORDER #      | STOCK #   | ORDER #      | STOCK #   | ORDER #      | STOCK #   |
| 3"     | 3DF304-15KT  | 810001942 | 3DF304-20KT  | 810001943 | 3DF304-25KT  | 810001944 |
| 4"     | 4DF304-15KT  | 810001947 | 4DF304-20KT  | 810001948 | 4DF304-25KT  | 810001949 |
| 5"     | 5DF304-15KT  | 810001952 | 5DF304-20KT  | 810001953 | 5DF304-25KT  | 810001954 |
| 5 1/2" | 55DF304-15KT | 810001957 | 55DF304-20KT | 810001958 | 55DF304-25KT | 810001959 |
| 6"     | 6DF304-15KT  | 810001962 | 6DF304-20KT  | 810001963 | 6DF304-25KT  | 810001964 |
| 7"     | 7DF304-15KT  | 810001967 | 7DF304-20KT  | 810001968 | 7DF304-25KT  | 810001969 |
| 8"     | 8DF304-15KT  | 810001972 | 8DF304-20KT  | 810001973 | 8DF304-25KT  | 810001974 |
| SIZE   | 30' FLEX     |           | 35' FLEX     |           |              |           |
|        | ORDER #      | STOCK #   | ORDER #      | STOCK #   |              |           |
| 3"     | 3DF304-30KT  | 810001945 | 3DF304-35KT  | 810001946 |              |           |
| 4"     | 4DF304-30KT  | 810001950 | 4DF304-35KT  | 810001951 |              |           |
| 5"     | 5DF304-30KT  | 810001955 | 5DF304-35KT  | 810001956 |              |           |
| 5 1/2" | 55DF304-30KT | 810001960 | 55DF304-35KT | 810001961 |              |           |
| 6"     | 6DF304-30KT  | 810001965 | 6DF304-35KT  | 810001966 |              |           |
| 7"     | 7DF304-30KT  | 810001970 | 7DF304-35KT  | 810001971 |              |           |
| 8"     | 8DF304-30KT  | 810001975 | 8DF304-35KT  | 810001976 |              |           |

## DuraFlex 304 Stainless Steel Length



Use with wood-pellet, non-condensing gas, wood-burning, and oil appliances. Custom lengths available for 3"-8" diameters. Minimum length of 10' for custom orders. Maximum 100' for 3" - 8". Must be ordered in increments of 10'.

3"-8" diameter flex can be ovalized up to the first 4'. Call Customer Service to add ovalizing to your order and for pricing.

| SIZE   | 15' FLEX    |           | 20' FLEX   |           | 25' FLEX   |           |
|--------|-------------|-----------|------------|-----------|------------|-----------|
|        | ORDER #     | STOCK #   | ORDER #    | STOCK #   | ORDER #    | STOCK #   |
| 3"     | 3DF304-15   | 810001984 | 3DF304-20  | 810001985 | 3DF304-25  | 810001986 |
| 4"     | 4DF304-15   | 810001990 | 4DF304-20  | 810001991 | 4DF304-25  | 810001992 |
| 5"     | 5DF304-15   | 810001996 | 5DF304-20  | 810001997 | 5DF304-25  | 810001998 |
| 5 1/2" | 55DF304-15  | 810002002 | 55DF304-20 | 810002003 | 55DF304-25 | 810002004 |
| 6"     | 6DF304-15   | 810002008 | 6DF304-20  | 810002009 | 6DF304-25  | 810002010 |
| 7"     | 7DF304-15   | 810002014 | 7DF304-20  | 810002015 | 7DF304-25  | 810002016 |
| 8"     | 8DF304-15   | 810002020 | 8DF304-20  | 810002021 | 8DF304-25  | 810002022 |
| SIZE   | 30' FLEX    |           | 35' FLEX   |           | 50' FLEX   |           |
|        | ORDER #     | STOCK #   | ORDER #    | STOCK #   | ORDER #    | STOCK #   |
| 3"     | 3DF304-30   | 810001987 | 3DF304-35  | 810001988 | --         | --        |
| 4"     | 4DF304-30   | 810001993 | 4DF304-35  | 810001994 | --         | --        |
| 5"     | 5DF304-30   | 810001999 | 5DF304-35  | 810002000 | --         | --        |
| 5 1/2" | 55DF304-30  | 810002005 | 55DF304-35 | 810002006 | --         | --        |
| 6"     | 6DF304-30   | 810002011 | 6DF304-35  | 810002012 | --         | --        |
| 7"     | 7DF304-30   | 810002017 | 7DF304-35  | 810002018 | 7DF304-50  | 810002019 |
| 8"     | 8DF304-30   | 810002023 | 8DF304-35  | 810002024 | 8DF304-50  | 810002025 |
| SIZE   | 100' FLEX   |           |            |           |            |           |
|        | ORDER #     | STOCK #   |            |           |            |           |
| 3"     | 3DF304-100  | 810001989 |            |           |            |           |
| 4"     | 4DF304-100  | 810001995 |            |           |            |           |
| 5"     | 5DF304-100  | 810002001 |            |           |            |           |
| 5 1/2" | 55DF304-100 | 810002007 |            |           |            |           |
| 6"     | 6DF304-100  | 810002013 |            |           |            |           |

# Custom Flex & Custom Flex Kits

Custom Kits are part of the program. Combine the DuraFlex length of your choice with any of our DuraFlex accessories to create your own custom kit. Customize your flex length by ovalizing the first 4'.

## Custom Flex Length Minimum order of 10 feet. 'XX' in stock number indicates feet.

| Flex         |         | 3"        | 4"        | 5"        | 5 1/2"     | 6"        | 7"        | 8"        | 10"        | 12"        |
|--------------|---------|-----------|-----------|-----------|------------|-----------|-----------|-----------|------------|------------|
| DuraFlex SW  | ORDER # | 3DFS-XX   | 4DFS-XX   | 5DFS-XX   | 55DFS-XX   | 6DFS-XX   | 7DFS-XX   | 8DFS-XX   | 10DFS-XX   | 12DFS-XX   |
|              | STOCK # | 810005857 | 810005969 | ---       | 810006039  | 810006167 | 810006657 | ---       | ---        | 810005041  |
| DuraFlex Pro | ORDER # | 3DFPRO-XX | 4DFPRO-XX | 5DFPRO-XX | 55DFPRO-XX | 6DFPRO-XX | 7DFPRO-XX | 8DFPRO-XX | 10DFPRO-XX | 12DFPRO-XX |
|              | STOCK # | 810002235 | 810002236 | 810002237 | 810002238  | 810002239 | 810002240 | 810002241 | 810004941  | 810007047  |
| DuraFlex 316 | ORDER # | 3DF316-XX | 4DF316-XX | 5DF316-XX | 55DF316-XX | 6DF316-XX | 7DF316-XX | 8DF316-XX | ---        | ---        |
|              | STOCK # | 80005853  | 810005961 | 810006059 | ---        | 810006157 | ---       | ---       | ---        | ---        |
| DuraFlex 304 | ORDER # | 3DF304-XX | 4DF304-XX | 5DF304-XX | 55DF304-XX | 6DF304-XX | 7DF304-XX | 8DF304-XX | ---        | ---        |
|              | STOCK # | ---       | 810005959 | 810006057 | 810006035  | 810006154 | ---       | 810006683 | ---        | ---        |

## Custom Ovalization of Flex

3"-8" diameter flex can be ovalized up to the first 4'. Call Customer Service to add ovalizing to your order and for pricing.

## Custom Flex Accessories for your Kit

| Accessories            | 3"        | 4"         | 5"         | 5 1/2"      | 6"         | 7"         | 8"         | 10"        | 12"        |
|------------------------|-----------|------------|------------|-------------|------------|------------|------------|------------|------------|
|                        | ORDER #   | ORDER #    | ORDER #    | ORDER #     | ORDER #    | ORDER #    | ORDER #    | ORDER #    | ORDER #    |
| Vertical Cap           | ---       | ---        | ---        | ---         | ---        | ---        | ---        | 10DFS-RCSC | 12DFS-RCSC |
| Top Plate              | ---       | ---        | ---        | ---         | ---        | ---        | ---        | 10DFS-TP   | 12DFS-TP   |
| Removable Vertical Cap | 3DFS-VCRC | 4DFS-VCRC  | 5DFS-VCRC  | 55DFS-VCRC  | 6DFS-VCRC  | 7DFS-VCRC  | 8DFS-VCRC  | ---        | ---        |
| Top Plate Storm Collar | 3DFS-TPSC | 4 DFS-TPSC | 5 DFS-TPSC | 55 DFS-TPSC | 6 DFS-TPSC | 7 DFS-TPSC | 8 DFS-TPSC | ---        | ---        |
| Vertical Cap Kit       | 3DFS-VCK  | 4DFS-VCK   | 5DFS-VCK   | 55DFS-VCK   | 6DFS-VCK   | 7DFS-VCK   | 8DFS-VCK   | --         | --         |
| Tee                    | 3DFS-T    | 4DFS-T     | 5DFS-T     | 55DFS-T     | 6DFS-T     | 7DFS-T     | 8DFS-T     | --         | --         |
| Connector              | 3DFS-FC   | 4DFS-FC    | 5DFS-FC    | 55DFS-FC    | 6DFS-FC    | 7DFS-FC    | 8DFS-FC    | 10DFS-FC   | 12DFS-FC   |
| Reducer                | --        | --         | --         | --          | 6DFS-X55   | --         | --         | --         | --         |
| Spacer                 | --        | --         | 5DFS-S     | --          | 6DFS-S     | 7DFS-S     | 8DFS-S     | --         | --         |
| Mortar Sleeve          | 3DFS-MS   | 4DFS-MS    | 5DFS-MS    | 55DFS-MS    | 6DFS-MS    | 7DFS-MS    | 8DFS-MS    | --         | --         |
| Flex Puller            | 3DFS-FP   | 4DFS-FP    | 5DFS-FP    | 55DFS-FP    | 6DFS-FP    | 7DFS-FP    | 8DFS-FP    | 10DFS-FP   | 12DFS-FP   |
| Spark Arrestor         | DFS-SA    | DFS-SA     | DFS-SA     | DFS-SA      | DFS-SA     | DFS-SA     | DFS-SA     | --         | --         |
| Tee w/ Removable Snout | --        | --         | --         | --          | --         | --         | --         | 10DFS-TRS  | 12DFS-TRS  |
| Tee Cap                | --        | --         | --         | --          | --         | --         | --         | 10DFS-TCV  | 12DFS-TCV  |
| Long Tee Snout         | --        | --         | --         | --          | --         | --         | --         | 10DFS-TLS  | 12DFS-TLS  |

Choose exactly the length of flex you need from 4 different choices...

Need smooth wall? An ultra flexible liner or maybe 304? No need to trouble yourself with cutting the length out in the field....we trim it exactly as you need it.

Ovalize the first 4 feet of the liner you purchase.

If you need the liner ovalized, be sure to let Customer Service know and the first 4' of the length will be ovalized.

Add exactly the parts you need in your kit.

Need a connector with a tee or cap? Customize your kit to get just what you need.



## Vertical Cap Kit

Top Plate with welded Storm Collar, and cap. Flex remains secured to the Storm Collar/Top Plate when removing the cap section for inspections and cleaning.



### DuraFlex Insert Adapter



Use to connect the flex to an insert that has a flat surfaced outlet.

| SIZE   | ORDER #   | STOCK #   |
|--------|-----------|-----------|
| 3"     | 3DFS-ADC  | 810008046 |
| 4"     | 4DFS-ADC  | 810008047 |
| 5"     | 5DFS-ADC  | 810008048 |
| 5 1/2" | 55DFS-ADC | 810008049 |
| 6"     | 6DFS-ADC  | 810008050 |
| 7"     | 7DFS-ADC  | 810008051 |
| 8"     | 8DFS-ADC  | 810008052 |

### DuraFlex SS Connector



3" - 8"

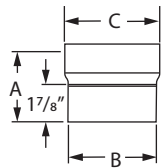

10" - 12"

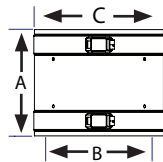

Use to connect DuraFlex SS length to an appliance, rigid length, or flex length. Drip-free connection.

| SIZE   | ORDER #  | STOCK #   | A      | B       | C       |
|--------|----------|-----------|--------|---------|---------|
| 3"     | 3DFS-FC  | 810002424 | 4 1/8" | 3"      | 3 1/2"  |
| 4"     | 4DFS-FC  | 810002432 | 4 1/8" | 4"      | 4 1/2"  |
| 5"     | 5DFS-FC  | 810002441 | 4 1/8" | 5"      | 5 1/2"  |
| 5 1/2" | 55DFS-FC | 810002451 | 4 1/8" | 6"      | 5 1/2"  |
| 6"     | 6DFS-FC  | 810002460 | 4 1/8" | 6 1/2"  | 6"      |
| 7"     | 7DFS-FC  | 810002469 | 4 1/8" | 7"      | 7 1/2"  |
| 8"     | 8DFS-FC  | 810002477 | 4 1/8" | 8"      | 8 1/2"  |
| 10"    | 10DFS-FC | 810016907 | 4 1/2" | 9 3/4"  | 10 3/8" |
| 12"    | 12DFS-FC | 810016909 | 4 1/2" | 11 3/4" | 12 3/8" |

### DuraFlex SS Reducer

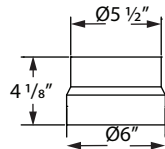

Use to connect 5 1/2" DuraFlex SS length to a 6" appliance. Check with the appliance manufacturer before reducing the vent size. May also be used to connect to stovepipe on a through masonry wall installations.

| SIZE   | ORDER #  | STOCK #   |
|--------|----------|-----------|
| 5 1/2" | 6DFS-X55 | 810002465 |

### DuraFlex SS Reducer w/clamp

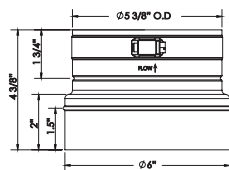

Use to connect 5 1/2" DuraFlex SS length to a 6" appliance. Check with the appliance manufacturer before reducing the vent size. May also be used to connect to stovepipe on a through masonry wall installations.

| SIZE   | ORDER #    | STOCK #   |
|--------|------------|-----------|
| 5 1/2" | 6DFS-X55WC | 810006168 |
| 5"     | 6DFS-X5WC  | 810006169 |

### DuraFlex SS Tee w/ Cap

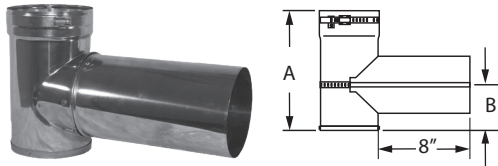

Use to attach to DuraFlex SS length with a fast connect band. Removable branch connects tee body with an internal fast connect band. 5 1/2" Tee has a 6" branch.

| SIZE   | ORDER # | STOCK #   | A       | B      |
|--------|---------|-----------|---------|--------|
| 3"     | 3DFS-T  | 810002423 | 8 1/2"  | 3 1/4" |
| 4"     | 4DFS-T  | 810002431 | 9 1/2"  | 4 1/4" |
| 5"     | 5DFS-T  | 810002440 | 9 1/2"  | 4 1/4" |
| 5 1/2" | 55DFS-T | 810002450 | 10 1/2" | 4 3/8" |
| 6"     | 6DFS-T  | 810002459 | 10 1/2" | 4 3/8" |
| 7"     | 7DFS-T  | 810002468 | 11 1/2" | 4 1/2" |
| 8"     | 8DFS-T  | 810002476 | 13"     | 5 3/4" |

### Spacer

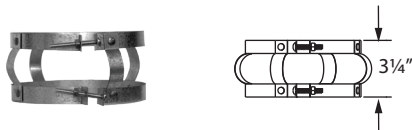

Use to maintain a 1" clearance with flex sections of DuraLiner and DuraFlex SS.

| SIZE | ORDER # | STOCK #   |
|------|---------|-----------|
| 5"   | 5DFS-S  | 810002442 |
| 6"   | 6DFS-S  | 810002461 |
| 7"   | 7DFS-S  | 810002470 |
| 8"   | 8DFS-S  | 810002478 |

### DuraFlex SS Top Plate and Storm Collar

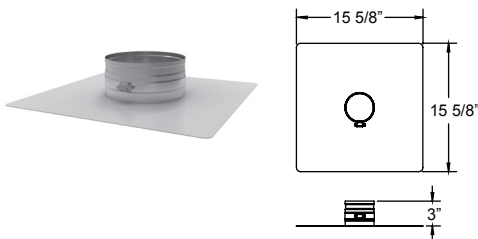

Used to seal top of masonry chimney and support flex. Flex is secured to storm collar with fast connect band.

| SIZE | ORDER #    | STOCK #   |
|------|------------|-----------|
| 3"   | 3DFS-TPSC  | 810017704 |
| 4"   | 4DFS-TPSC  | 810017705 |
| 5"   | 5DFS-TPSC  | 810017706 |
| 5.5" | 55DFS-TPSC | 810017707 |
| 6"   | 6DFS-TPSC  | 810017708 |
| 7"   | 7DFS-TPSC  | 810017709 |
| 8"   | 8DFS-TPSC  | 810017710 |

### DuraFlex SS Top Plate

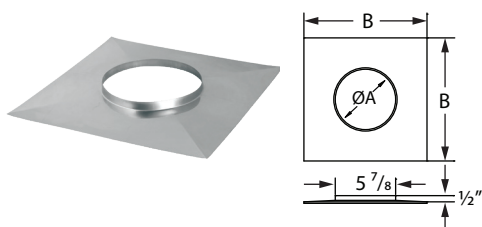

Use to seal top of masonry chimney and support the flex.

| SIZE | ORDER #  | STOCK #   | A       | B   |
|------|----------|-----------|---------|-----|
| 10"  | 10DFS-TP | 810016955 | 10 1/4" | 18" |
| 12"  | 12DFS-TP | 810016957 | 12 1/4" | 18" |

### DuraFlex SS Removable Vertical Cap

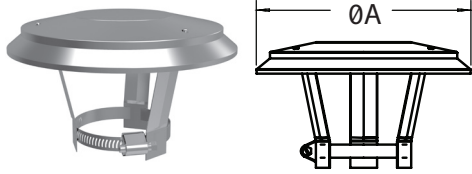

Use to terminate a relining system. Attach to storm collar with fast connect band. Optional spark arrestor available.

| SIZE | ORDER #    | STOCK #   | A   |
|------|------------|-----------|-----|
| 3"   | 3DFS-VCRC  | 810017306 | 8"  |
| 4"   | 4DFS-VCRC  | 810017307 | 8"  |
| 5"   | 5DFS-VCRC  | 810017308 | 11" |
| 5.5" | 55DFS-VCRC | 810017309 | 11" |
| 6"   | 6DFS-VCRC  | 810017310 | 11" |
| 7"   | 7DFS-VCRC  | 810017311 | 15" |
| 8"   | 8DFS-VCRC  | 810017312 | 15" |

### DuraFlex SS Cap

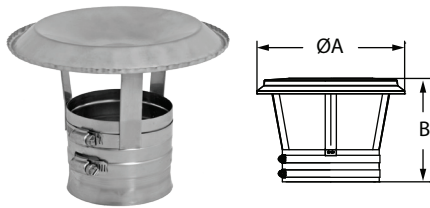

Use to terminate a relining system at the top of the masonry chimney. Supports flex with a fast connect band. Optional Spark Arrestor available. Use to support liner from the top and form a seal between the Storm Collar and the Top Plate. Top is removable for easy access to chimney cleaning.

| SIZE | ORDER #    | STOCK #   | A   | B  |
|------|------------|-----------|-----|----|
| 10"  | 10DFS-RCSC | 810016941 | 19" | 8" |
| 12"  | 12DFS-RCSC | 810016943 | 21" | 8" |

### Spark Arrestor

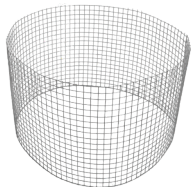

Use on inside of cap. Optional Spark Arrestor may be required. For 3"-8" diameters. Trim length to fit specific size.

| SIZE  | ORDER # | STOCK #   |
|-------|---------|-----------|
| 3"-8" | DFS-SA  | 810002428 |

### Sleeve

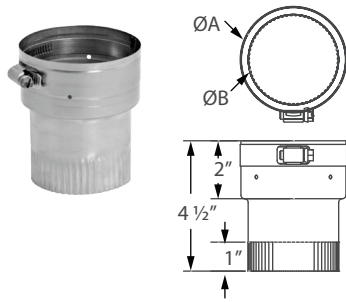

Use to connect a liner into an appliance flue collar.

| SIZE   | ORDER #   | STOCK #   | A        | B   |
|--------|-----------|-----------|----------|-----|
| 4"     | 4DFS-SLV  | 810016910 | 4 1/8"   | 4"  |
| 5"     | 5DFS-SLV  | 810016911 | 5 1/8"   | 5"  |
| 5 1/2" | 55DFS-SLV | 810016912 | 5 3/4"   | 6"  |
| 6"     | 6DFS-SLV  | 810016913 | 6 1/8"   | 6"  |
| 7"     | 7DFS-SLV  | 810016914 | 7 1/2"   | 7"  |
| 8"     | 8DFS-SLV  | 810016915 | 8 3/16"  | 8"  |
| 10"    | 10DFS-SLV | 810016917 | 10 3/16" | 10" |
| 12"    | 12DFS-SLV | 810016919 | 12 1/4"  | 12" |

### Tee w/ Removable Snout



Use as a 90° transition between liner and connector pipe at the wall thimble or rear flue outlet of a heater. Removable Snout with internal draw band allows for easier, through the wall thimble installation.

| SIZE | ORDER #   | STOCK #   | ORDER #  | STOCK #   | A        | B       | C       |
|------|-----------|-----------|----------|-----------|----------|---------|---------|
| 10"  | 10DFS-TRS | 810016929 | 10VG-TRS | 810001889 | 10 3/16" | 10 1/8" | 16 1/2" |
| 12"  | 12DFS-TRS | 810016931 | 12VG-TRS | 810001905 | 12 1/4"  | 12"     | 18"     |

### Tee Cap



Attach to bottom of tee body. Provides access for cleaning.

| SIZE | ORDER #   | STOCK #   |
|------|-----------|-----------|
| 10"  | 10DFS-TCV | 810016933 |
| 12"  | 12DFS-TCV | 810016935 |

### Long Tee Snout



Use to increase reach through masonry at wall thimble.

| SIZE | ORDER #   | STOCK #   |
|------|-----------|-----------|
| 10"  | 10DFS-TLS | 810016937 |
| 12"  | 12DFS-TLS | 810016939 |

### DuraFlex Mortar Sleeve

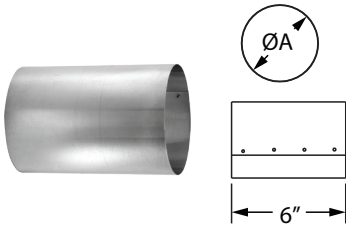

Use to protect DuraFlex when passing length through a masonry wall.

| SIZE   | ORDER #  | STOCK #   | A      |
|--------|----------|-----------|--------|
| 3"     | 3DFS-MS  | 810002425 | 4"     |
| 4"     | 4DFS-MS  | 810002433 | 5"     |
| 5"     | 5DFS-MS  | 810002443 | 6"     |
| 5 1/2" | 5SDFS-MS | 810002452 | 6 1/2" |
| 6"     | 6DFS-MS  | 810002462 | 7"     |
| 7"     | 7DFS-MS  | 810002471 | 8"     |
| 8"     | 8DFS-MS  | 810002479 | 9"     |

## DuraFlex Flex Puller

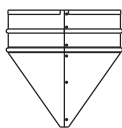

Use with a rope to guide DuraFlex lengths down masonry chimney.

| SIZE   | ORDER #  | STOCK #   |
|--------|----------|-----------|
| 3"     | 3DFS-FP  | 810002426 |
| 4"     | 4DFS-FP  | 810002434 |
| 5"     | 5DFS-FP  | 810002444 |
| 5 1/2" | 55DFS-FP | 810002453 |
| 6"     | 6DFS-FP  | 810002463 |
| 7"     | 7DFS-FP  | 810002472 |
| 8"     | 8DFS-FP  | 810002480 |
| 10"    | 10DFS-FP | 810016960 |
| 12"    | 12DFS-FP | 810016962 |

# Insulation

## TherMix



Use to fill space between a liner and inside masonry chimney. Ready-mix formula cures into lightweight. Semi hard mass that insulates the liner and dissipates the intense heat created in a chimney fire.

\*Use Table 1 to estimate the number of TherMix bags or boxes needed to do the job.

- Find the flue opening that comes closest to the one being lined, the left hand column.
- Find the size of the liner to be installed across the top line.
- Where the values intersect, read the cubic foot volume of TherMix per foot of chimney height.
- Multiply this volume by the height (in feet) of the chimney.
- Divide the cubic feet calculated in the previous step by 3.25. This answer will determine the number of bags/boxes of TherMix needed.

| SIZE | ORDER # | STOCK #   |
|------|---------|-----------|
| BAG  | RNS-TMG | 810001820 |
| BOX  | RNS-TMX | 810001821 |

### Example:

A 28' chimney with a flue opening of 8.5" x 8.5" is to be lined with a 6" liner. As shown in Table 1, .30ft<sup>3</sup> of TherMix is needed per foot of chimney height. Multiply .30 by 28 (the height of the chimney), to get 8.4ft<sup>3</sup>. Now divide 8.4 by 3.25 (the approximate volume yield per bag of TherMix), to obtain 2.6 bags/boxes of TherMix to complete the installation.

\*Masonry chimneys are not uniform structures. Have extra bags/boxes available in case you need them. If there is an installation not covered by table 1, refer to the formula below:

$$\text{Packages of TherMix} = \frac{(W \times D \times H) - (CS \times H)}{1728 \text{ cu. in.}} \div 3.25$$

- W = Width of flue opening (in inches)
- D = Depth of flue opening (in inches)
- H = Height of flue (in inches)
- CS = Cross Section areas of chimney liner (table 2)

**TABLE 1: THERMIX VOLUME PER ONE FOOT OF CHIMNEY HEIGHT**

| Flue Opening  | Diameter of Liner |      |                |                |                |      |
|---------------|-------------------|------|----------------|----------------|----------------|------|
|               | 5"                | 6"   | 7"             | 8"             | 10"            | 12"  |
| 7.5" x 7.5"   | .25               | .20  | --             | --             | --             | --   |
| 7.5" x 11.5"  | .46               | .40  | (Ovalized) .38 | (Ovalized) .32 | --             | --   |
| 8.5" x 8.5"   | .36               | .30  | .23            | --             | --             | --   |
| 8.5" x 11.5"  | .54               | .48  | .41            | (Ovalized) .36 | (Ovalized) .33 | --   |
| 9.5" x 9.5"   | .49               | .43  | .36            | .27            | --             | --   |
| 11.5" x 11.5" | .78               | .72  | .65            | .60            | .37            | --   |
| 11.5" x 16.5" | 1.18              | 1.12 | 1.05           | .96            | .77            | --   |
| 12.5" x 12.5" | .95               | .88  | .82            | .73            | .53            | --   |
| 14.5" x 14.5" | 1.30              | 1.26 | 1.20           | 1.10           | .92            | .65  |
| 14.5" x 18.5" | 1.70              | 1.66 | 1.60           | 1.50           | 1.30           | 1.04 |

**TABLE 2: CROSS SECTION AREA OF LINER**

| Liner Size | CS Area               | Oval Liner Size | Oval Dimensions | CS Area              |
|------------|-----------------------|-----------------|-----------------|----------------------|
| Round 5"   | 19.62in <sup>2</sup>  |                 |                 |                      |
| Round 6"   | 28.46in <sup>2</sup>  | Oval 6"         | (4.2" x 7.2")   | 24.60in <sup>2</sup> |
| Round 7"   | 38.46in <sup>2</sup>  | Oval 7"         | (4.2" x 9.1")   | 32.20in <sup>2</sup> |
| Round 8"   | 50.25in <sup>2</sup>  | Oval 8"         | (4.2" x 10.3")  | 37.20in <sup>2</sup> |
| Round 9"   | 62.50in <sup>2</sup>  |                 |                 |                      |
| Round 10"  | 78.50in <sup>2</sup>  | Oval 10"        | (4.2" x 13.3")  | 49.50in <sup>2</sup> |
| Round 12"  | 113.22in <sup>2</sup> |                 |                 |                      |

### ProMesh Insulation Kit



3" - 6" Diameter Insulation Kit includes: 22"x 25 Feet of ProFoil, 12" x 25 Feet ProMesh, and 2" x 150 Feet AL tape

| SIZE    | ORDER # | STOCK #   |
|---------|---------|-----------|
| 3" - 6" | 6RNS-IK | 810012842 |

### ProFoil



Use as insulator for stainless steel liners in masonry chimneys. UL Listed insulation. Size is based on vent diameter.

Required to insulate stainless steel liner to meet UL 1777 when proper clearances to chimney and framing are not available. 1" clearance from SS liner to interior wall of the masonry chimney and 1" clearance from the masonry to the house framing are required in order to meet UL 1777. If you do not have either of these clearances then a 1/2" wrap is required. If these two clearances are available then no insulation is needed. AluFoil Tape and ProMesh required.

| SIZE    | FITS Ø    | THICKNESS | ORDER #         | STOCK #   |
|---------|-----------|-----------|-----------------|-----------|
| 22"x25' | 3"-5 1/2" | 1/2"      | 56RNS-PFB22X25  | 810001822 |
| 24"x25' | 6"        | 1/2"      | 7RNS-PFB24X25   | 810001823 |
| 29"x25' | 7"        | 1/2"      | 8RNS-PFB29X25   | 810001824 |
| 48"x25' | 8"-12"    | 1/2"      | 912RNS-PFB48X25 | 810001825 |

### AluFoil Tape



Use to seal seams of ProFoil insulation. 2 mil aluminum foil tape has strength and adhesion.

| SIZE      | ORDER # | STOCK #   |
|-----------|---------|-----------|
| 3" x 150' | RNS-ALF | 810002486 |

### ProMesh



Use to protect the ProFoil during installation. 304 stainless steel mesh slides over insulated liner. Shrinks to fit liner when pulled length-wise.

| SIZE                | ORDER # | STOCK #   | LENGTH |
|---------------------|---------|-----------|--------|
| SM - for Ø3"-Ø 6"   | RNS-PM1 | 810012553 | 25'    |
| LG - for Ø7"-Ø9"    | RNS-PM2 | 810012554 | 25'    |
| XLG - for Ø10"-Ø12" | RNS-PM3 | 810012555 | 25'    |



# What makes us different from the rest?

DuraFlex: A range of flexible stainless steel relining to make the right decision for the right situation.

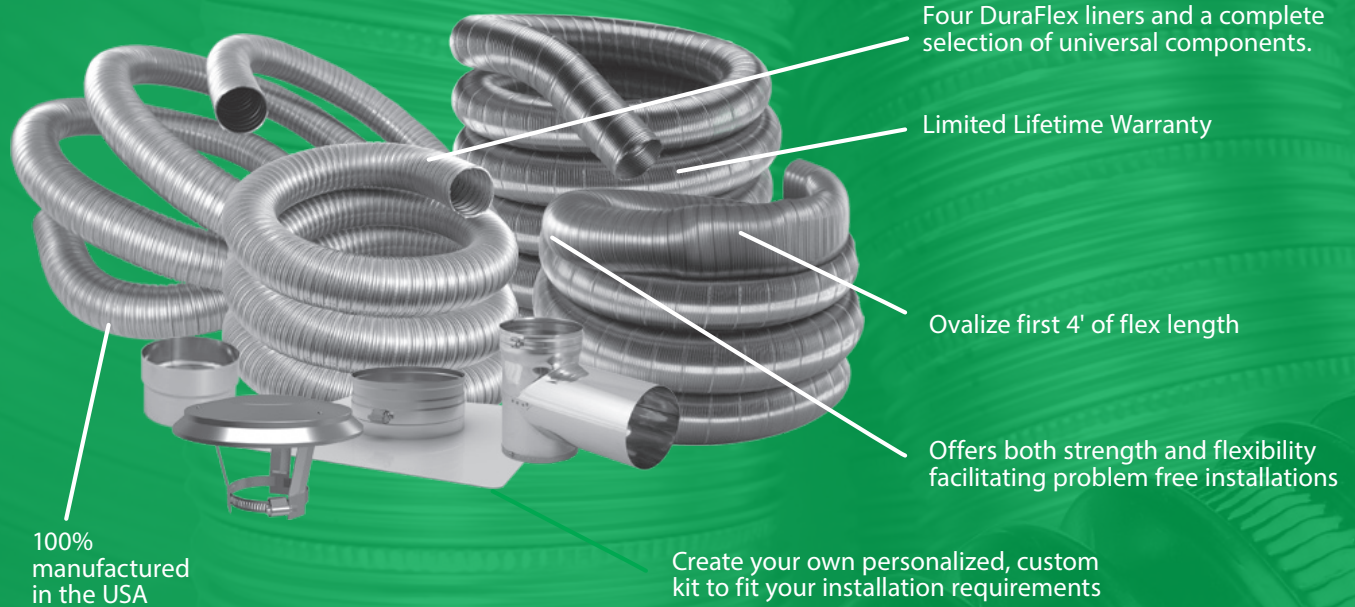

| DuraFlex Feature           | Benefit  | DuraFlex Feature                           | Benefit  | DuraFlex Feature          | Benefit  |
|----------------------------|--|--|--|---------------------------|--|
| Flexible installation      | DuraVent offers the installer a range of products to make the right decision for the right situation offering four different DuraFlex liners and a complete selection of universal components. | Alternative lining materials to clay tiles | DuraVent liners are tested and listed as alternative lining materials to standard clay tiles and can be installed into existing clay tiles or clay tiles may be removed and replaced with a DuraVent liner.                              | Built-in draw band        | DuraVent caps and tees are manufactured with built-in draw bands, eliminating the need for pre-drilling liners or using pop rivets.  |
| Custom lengths and kits    | All DuraFlex is available for orders requiring custom lengths eliminating the need to cut lengths in the field.  | Smooth wall option                         | The smooth inner wall provides for no output reduction allowing for full appliance efficiency and does not include ridges that restrict flue gas flow and collects deposits. Lack of ridges facilitates cleaning and maintenance.        | Self-straightening liner  | DuraFlex Pro is extremely flexible that self straightens when taken out of the box. There is no need to wrestle with the liner to get it straightened out. Little to no machine oil residue left on liner. |
| Custom kits                | Combine any DuraFlex liner and length with any DuraFlex accessories to create your own personalized, custom kit to fit your installation requirements.   |  |  |                           |  |
| Oval Options               | Ovalize first 4' of flex length.   | Combination of strength and flexibility    | DuraFlex Pro offers both strength and flexibility, featuring 20% more stainless steel per foot compared to other liners on the market. Its extreme flexibility facilitates problem free installations where multiple offsets are needed. | Limited Lifetime Warranty | The best Warranty in the industry. 15 years 100%, 15 years and up 50%. Gives the installer and home owner the greatest peace of mind in a quality installation.  |
| UL1777 and ULC S635 listed | DuraLiner meets all the thermal, mechanical and material requirement of the UL1777 and ULC S635 (MH14420) standards.   |  |  | Made in USA               | 100% manufactured in US  |