



**OUTDOOR DOUBLE DRAWER  
REFRIGERATOR**

**User's Manual**

Model Number: BLZ-SSRF-DBDR5.1



**CALIFORNIA PROPOSITION 65 WARNING**

WARNING: This product can expose you to chemicals including Chromium (hexavalent compounds), which are known to the State of California to cause cancer and birth defects or other reproductive harm. For more information go to:

[www.P65Warnings.ca.gov](http://www.P65Warnings.ca.gov)

**BEFORE USE, PLEASE READ AND FOLLOW ALL SAFETY RULES AND OPERATING INSTRUCTIONS.**

## TABLE OF CONTENTS

Appliance Safety	3
Important Safeguards	3-4
Installation Instructions	
Before Using Your Appliance	5
Installation of Your Appliance	5
Site Preparation	5
Anti-Tip Bracket Installation	6-7
Leveling the Unit	8
Installing Handle	8
Electrical Connection	8
Extension Cord	9
Operating Your Appliance	
Control Panel	9
Defrosting	10
Temperature Alarm/Door Alarm	10
Care and Maintenance	
Cleaning and Maintaining Your Appliance	10
Power Failure	11
Vacation Time	11
Moving Your Appliance	11
Energy Saving Tips	11
Troubleshooting	12
Warranty	13

## APPLIANCE SAFETY

**Your safety and the safety of others are very important.**

We have provided many important safety messages in this manual and on your appliance. Always read and obey all safety messages.

This is the Safety Alert Symbol. The symbol alerts you to potential hazards that can kill or injure you and others. All safety messages will follow the Safety

Alert Symbol and either the word DANGER or WARNING.

### **DANGER**

DANGER means that failure to heed this safety statement may result in severe personal injury or death.

### **WARNING**

WARNING means that failure to heed this safety statement may result in extensive product damage, serious personal injury, or death.

All safety messages will alert you about the potential hazard, tell you how to reduce the chance of injury, and let you know what can happen if the instructions are not followed.

## IMPORTANT SAFEGUARDS

Before the appliance is used, it must be properly positioned and installed as described in this manual, so read the manual carefully. To reduce the risk of fire, electrical shock or injury when using the appliance, follow basic precautions, including the following:



Plug into a grounded 3 prong outlet, do not remove grounding prong, do not use an adapter, and do not use an extension cord.

Replace all panels before operating

It is recommended that a separate circuit serving only your appliance be provided. Use receptacles that cannot be turned off by a switch or pull chain

Never clean appliance parts with flammable fluids. These fumes can create a fire hazard or explosion. And do not store or use gasoline or other flammable vapors and liquids in the vicinity of this or any other appliance. The fumes can create a fire hazard or explosion.

Do not connect or disconnect the electric plug when your hands are wet.

Unplug the appliance or disconnect power before cleaning or servicing. Failure to do so can result in electrical shock or death.

Do not attempt to repair or replace any part of your appliance unless it is specifically recommended in this manual. All other servicing should be referred to a qualified technician

**⚠ WARNING ⚠**

FOLLOW WARNING CALL OUTS BELOW ONLY WHEN APPLICABLE TO YOUR MODEL

Use two or more people to move and install appliance. Failure to do so can result in back or other injury.

To ensure proper ventilation for your appliance, the front of the unit must be completely unobstructed. Choose a well-ventilated area with temperatures above 50°F (10°C) and below 109.4°F (43°C).

The appliance should not be located next to ovens, grills or other sources of high heat.

The appliance must be installed with all electrical, water and drain connections in accordance with state and local codes. A standard electrical supply (115 V AC only, 60 Hz), properly grounded in accordance with the National Electrical Code and local codes and ordinances, is required.

Do not kink or pinch the power supply cord of the appliance. The size of the fuse (or circuit breaker) should be 1.3 amperes.

It is important that the appliance be leveled in order to work properly. You may need to make several adjustments to level it.

All installations must be in accordance with local plumbing code requirements. Make certain that the pipes are not pinched, kinked or damaged during installation. Check for leaks after connection.

Never allow children to operate, play with or crawl inside the appliance.

Do not use solvent-based cleaning agents or abrasives on the interior. These cleaners may damage or discolor the interior.

Use this appliance only for its intended purpose as described in this *Instruction Manual*.

Keep fingers out of the "pinch point" areas. Clearances between the door and cabinet are necessarily small. Be careful closing door when children are in the area.

**⚠ DANGER ⚠ Risk of child entrapment!**

Child entrapment and suffocation are not problems of the past. Junked or abandoned appliances are still dangerous, even if they will "just sit for a few days".

*Before discarding your old refrigerator:*

*Take off the doors*

*Leave the shelves in place so that children may not easily climb inside.*

**- SAVE THESE INSTRUCTIONS -**

# INSTALLATION INSTRUCTIONS

## **BEFORE USING YOUR APPLIANCE**

Remove the exterior and interior packaging.

Before connecting the appliance to the power source, let it stand upright for approximately 24 hours. This will reduce the possibility of a malfunction in the cooling system from handling during transportation.

Clean the interior surface with lukewarm water using a soft cloth.

Install the handle on the door, if it is not already attached (See page 7).

## **INSTALLATION OF YOUR APPLIANCE**

Your outdoor drawers' refrigerator has been designed for both built-in and free standing. When built-in, your refrigerator drawers do not require additional air space for top, side, or rear, the front grille must NOT be obstructed.

**Note:** It is recommended that you do not install the appliance near an oven, radiator, or other heating source. And heat sources may increase electrical consumption. Don't install in a location where the temperature will fall below 50°F (10°C). For best performance, do not install the appliance behind a cabinet door or block the base grille.

Avoid locating the unit in moist areas.

Plug the appliance into an exclusive, properly grounded wall outlet.

## **SITE PREPARATION**

1. Position the unit on a flat, level surface capable of supporting the entire weight of the unit. Remember the unit will be significantly heavier once it is fully loaded.
2. Avoid connecting the unit to a Ground Fault Interrupter (GFI). GFIs are prone to nuisance tripping which will cause the unit to shut down. GFIs are generally not used on circuits which power equipment that must run unattended for long periods of time.
3. The unit must be installed according to your local codes and ordinances.
4. **ELECTROCUTION HAZARD!**



Electrical Grounding Required - This appliance is equipped with a three prong (grounding) polarized plug for your protection against possible shock hazards.

- NEVER remove the round grounding prong from the plug.
- NEVER use a two-prong grounding adapter.
- NEVER use an extension cord to connect power to the unit.

Where a two-prong wall receptacle is encountered or a longer power cord is required, contact a qualified electrician to have it replaced in accordance with applicable electrical codes.

- Position the unit to allow free air flow through the front grille.

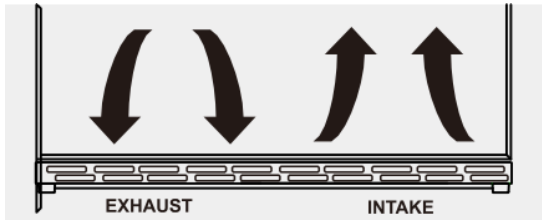

- Wipe out inside of unit with a damp cloth.
- Be sure to install the Anti-Tip bracket. Follow the instructions provided with the Anti-Tip bracket kit.



The Anti-Tip Kit must be installed on this unit before it is used. Double stacking units may cause serious personal injury.

## **ANTI-TIP BRACKET INSTALLATION**

To reduce the risk of tipping the unit by abnormal usage or improper loading secured by properly installing the anti-tip device packed.

### **Operation step 1:**

Place the anti-tip bracket on the floor as show in the figure. An anti-tip bracket can be installed on eight right or left side. Keep the tow bracket distance in 565mm, as picture 2.

Then mark the location of the 4 holes of the anti-tip bracket on the floor. Use a 5/16 masonry drill bit and insert plastic anchors.

Secure bracket to floor using screws.

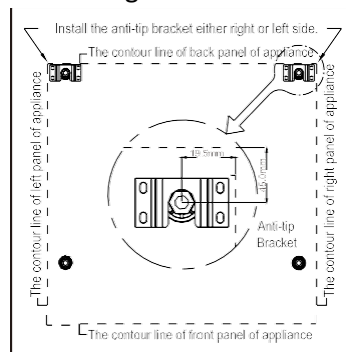

Picture 1

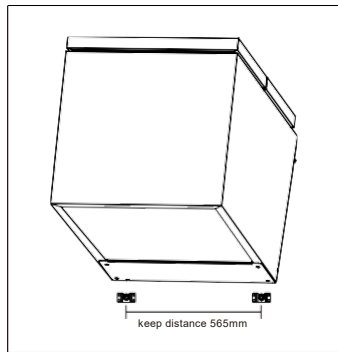

Picture 2

### Operation step 2:

Lift the bottom of the unit as picture 3

Then use the screwdriver to take out the screws which point out in picture 3. Loosening lower front foot which point in picture 4 about 2.5mm to 3mm

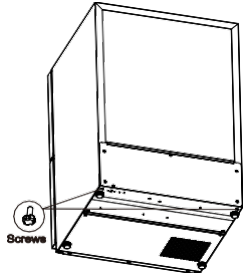

Picture 3

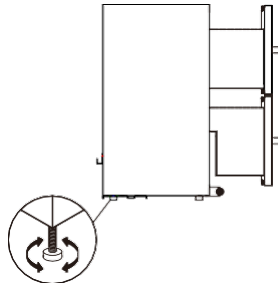

Picture 4

**Noted: Do not loosening the lower front foot too much, or it will easy to fall off.**

### Operation Step 3:

Tilt the unit forward slightly and make sure the unit is a little higher than the Anti-Tip Bracket when moving the appliance to the final position.

Slide the appliance into position and make sure the leg engages the anti-tip bracket.

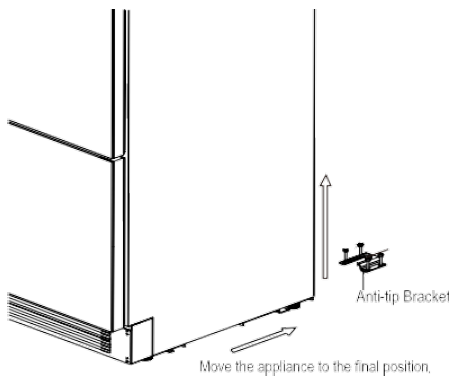

**Noted: If the unit is relocated, the bracket must be removed and installed in the new location.**

## **LEVELING THE UNIT**

Position the unit on a flat, level surface capable of supporting the entire weight of the unit when full.

This unit contains (4) adjustable leveling legs. Turn the legs clockwise to raise and counterclockwise to lower.

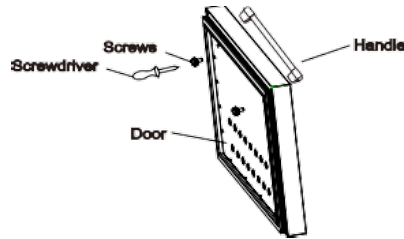
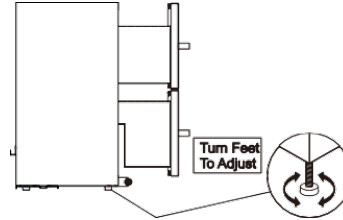

- Put the screws on the top of door where the handle is to be installed.
- Align the handle with screws, tighten the screws using the screwdrivers.

## **ELECTRICAL CONNECTION**



### **WARNING**

Improper use of the grounded plug can result in the risk of electrical shock. If the power cord is damaged, have it replaced by a qualified electrician or an authorized service center.

This appliance should be properly grounded for your safety. The power cord of this appliance is equipped with a three-prong plug which mates with standard three-prong wall outlets to minimize the possibility of electrical shock.

Do not under any circumstances cut or remove the third (ground) prong from the power cord supplied. For personal safety, this appliance must be properly grounded. Any questions concerning power and/or grounding should be directed toward a certified electrician or an authorized service center.

This appliance requires a standard 115/120 Volt AC~60Hz three prong grounded electrical outlet. Have the wall outlet and circuit checked by a qualified electrician to make sure the outlet is properly grounded. When a standard 2-prong wall outlet is encountered, it is your responsibility and obligation to have it replaced with a properly grounded 3-prong wall outlet.

To prevent accidental injury, the cord should be secured behind the appliance and not left exposed or dangling.

The appliance should always be plugged into its own individual electrical outlet which has a voltage rating that matches the rating label on the appliance. This provides the best performance and also prevents overloading house wiring circuits that could cause a fire hazard from overheating. Never unplug the appliance by pulling on the power cord. Always grip the plug firmly and pull straight out from the receptacle. Repair or replace immediately all power cords or abrasion damage along its length or at either end. When moving the appliance, be careful not to damage the power cord.



## **EXTENSION CORD**

Because of potential safety hazards under certain conditions, it is strongly recommended that you do not use an extension cord with this appliance. However, if you must use an extension cord it is absolutely necessary that it be a UL/CUL-Listed, 3-wire grounding type appliance extension cord having a grounding type plug and outlet that the electrical rating of the cord be 115 volts and at least 1.3 amperes.

## **OPERATING YOUR APPLIANCE**

It is recommended that you install the appliance in a place where the ambient temperature is between 50°F and 109.4°F (10°C-43°C). If the ambient temperature is above or below recommended temperatures, the performance of the unit may be affected. For example, placing your unit in extremely cold or hot conditions may cause interior temperatures to fluctuate. The operating temperature range may not be reached.

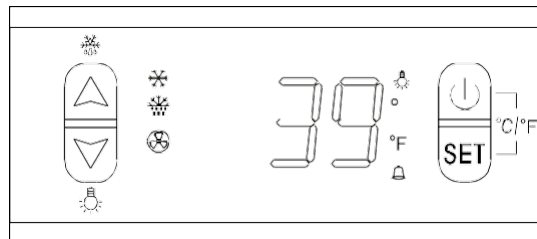

## **CONTROL PANEL**



### **ON/OFF Power**



To turn the appliance ON or OFF , press and hold the POWER key  for 5 seconds.

### **UP and DOWN**



Press  first ,then press  or  button to increase(warm) or decrease(cool) the set temperature by 1°C/1°F.

Press  again, the temperature is selected and shows the actual temperature. If no other further operation in 6 seconds, display will show actual temperature in the cooler.

### **°C/°F Selector**

Selects the temperature display setting in Fahrenheit or Celsius degrees .To change the temperature from Fahrenheit to Celsius or from Celsius to Fahrenheit, press  and  at the sametime, then hold for 6 seconds.

### **Setting the Temperature Control**

The temperature you are setting will increase by one degree each time you press the  key, and will decrease by one degree each time you press the  key.

The range of the temperature control is from °F to °F.

To view the set temperature at any time, press the  key. The set temperature will flash in the display window for 6 seconds. After 6 seconds, the temperature inside the unit will reappear in the display window.

(The temperature preset at the factory is 39°F).

### **Interior Light**

The unit is equipped with an interior LED light which will be turned ON when the door is open.

And the interior fan is stopped at the same time.

You can press  manually to turn on or turn off the light.

### **DEFROSTING**

The unit defrosts automatically in normal operating conditions.

The evaporator behind the rear wall of the unit defrosts automatically. The condensate collects in the drainage channel behind the rear wall of the unit, and flows through the drainage hole into the drip tray by the compressor where it evaporates.

However, frost may accumulate on the evaporator if the unit is repeatedly opened in a high heat or high humidity location. If this frost pattern does not clear within 24 hours, your unit will require manual defrosting.

Press  and hold for 6 seconds, the unit will be defrosted.

To stop defrost, please repeat the same interaction.

### **TEMPERATURE ALARM**

An audible alarm sounds if the storage temperature is not cold enough. The temperature display flashes at the same time.

The cause of the temperature being too high may be:

- Warm fresh food was placed inside
- Too much warm ambient air flowed in when rearranging and removing stored items
- Power failure for some time
- The appliance is faulty

The audible alarm is automatically silenced and the temperature display stops flashing when the temperature is sufficiently cold again.

## **CARE AND MAINTENANCE**

### **CLEANING AND MAINTAINING YOUR APPLIANCE**

Periodic cleaning and proper maintenance will ensure efficiency, top performance, and long life. The maintenance intervals listed are based on normal conditions. You may want to shorten the intervals if you have pets or other special considerations.

Exterior Cleaning for Your Stainless Steel Model:

- Your stainless steel model may discolor when exposed to chlorine gas, pool chemicals, salt water, or cleaners with bleach
- Keep your stainless unit looking new by cleaning with a high-quality, all-in-one stainless steel cleaner/polish on a monthly basis. Frequent cleaning will remove surface contamination that could lead to rust. Some installations will require cleaning on a weekly basis.
- DO NOT CLEAN WITH STEELWOOL PADS.
- DO NOT USE CLEANERS THAT ARE NOT SPECIFICALLY INTENDED FOR STAINLESS STEEL (this includes glass, tile and counter cleansers).
- If any surface discolors or rusting appears, clean it quickly with Bom-Ami or Barkeepers Friend Cleanser and a non-abrasive cloth. Always clean in the direction of the grain. Always finish this process with a high-quality, all-in-one stainless cleaner/polish to prevent further problems.
- USE OF ABRASIVE PADS SUCH AS SCOTCHBRITE WILL CAUSE THE GRAINING IN THE STAINLESS TO BECOME BLURRED.
- Rust that is allowed to linger can penetrate into the surface of the stainless steel and become impossible to remove.



- Stainless steel models exposed to chlorine gas and moisture such as areas with spas or swimming pools, may have some discoloration of the stainless steel. Discoloration from chlorine gas is normal. Follow exterior cleaning instructions.
- NEVER USE CHLORIDE TO CLEAN STAINLESS STEEL.

### **POWER FAILURE**

Most power failures are corrected within a few hours and should not affect the temperature of your appliance if you minimize the number of times the door is opened. If the power is going to be off for a longer period of time, you need to take the proper steps to protect the contents.

### **VACATION TIME**

Short Vacations: Leave the appliance operating during vacations of less than three weeks.

Long Vacations: If the appliance will not be used for several months, remove all items and turn off the appliance. Clean and dry the interior thoroughly. To prevent odor and mold growth, leave the door open slightly, blocking it open if necessary.

### **MOVING YOUR APPLIANCE**

1. Remove all items.
2. Securely tape down all loose items (shelves) inside your appliance.
3. Turn the adjustable legs up to the base to avoid damage.
4. Tape the door shut.
5. Be sure the appliance stays secure in the upright position during transportation. Also protect the outside of the appliance with a blanket or similar item.

### **ENERGY SAVING TIPS**

The appliance should be located in the coolest area of the room or outdoor location, away from heat-producing appliances and out of direct sunlight.

Ensure that the unit is adequately ventilated. Never cover air vents. Do not keep the door open any longer than necessary.

Let hot foods cool to room temperature before placing in the unit. Overloading the unit forces the compressor to run longer.

Be sure to wrap foods properly, and wipe containers dry before placing them in the unit. This cuts down on frost build up inside the unit.

Unit shelves and storage bins should not be lined with aluminum foil, wax paper or paper toweling.

Liners interfere with cold air circulation, making the unit less efficient.

Organize and label stored items to reduce door openings and extended searches. Remove as many items as needed at one time, and close the door as soon as possible.

## TROUBLESHOOTING

You can solve many common problems easily, saving you the cost of a possible service call. Try the suggestions below to see if you can solve the problem before calling the servicer.

### Troubleshooting Guide

PROBLEM	POSSIBLE CAUSE	REMEDY
Appliance does not operate.	Appliance is not connected to a power supply. The appliance is turned off. Tripped circuit breaker or a blown fuse.	Connect the appliance.  Switch on the appliance Switch on circuit breaker or replace fuse.
Appliance is not cold enough.	The temperature is not set correctly. The ambient temperature could require a lower temperature setting. The door was opened too often.  The door was not closed completely. Door is not hermetically sealed.  The condenser is too dirty. The ventilation opening is blocked or too dusty.	Check the set temperature. Set a lower temperature  Do not open the door more often than necessary. Close door properly. Check the door seal and clean or replace. Clean the condenser when necessary. Clear the obstructions and clean the dust.
Appliance turns itself on and off frequently.	The room temperature is higher than average A large amount of food has been added to the unit.  The door is open too often.  The door is not closed completely. The door gasket does not seal properly.	Put the appliance in a cooler place.  Leave the appliance to work for a while until the set temperature has been reached. Do not open the door more often than necessary. Close door properly. Check the door seal and clean or replace.
The light does not work.	Appliance is not connected to a power supply. Tripped circuit breaker or a blown fuse. The light was switched off on the control panel.	Connect the appliance.  Switch on circuit breaker or replace fuse Switch on the light.
Vibrations	The appliance is not properly leveled.	Level the appliance with the adjustable feet.
The appliance seems to make too much noise.	The rattling noise may come from the flow of the refrigerant, which is normal. As each cycle ends, you may hear gurgling sounds caused by the flow of refrigerant in your appliance If temperature fluctuations occur, the contraction and expansion of the inner walls may cause popping and cracking noises.	
	The appliance is not properly level.	Level the appliance with the adjustable feet.
The door will not close properly.	The appliance is not properly level.  The door was reversed and not properly installed. The gasket is dirty. The shelves are out of position.	Level the appliance with the adjustable feet. Check the door hinge and reassemble correctly. Clean the door gasket. Check the shelves and refit correctly,
The alarm sounds and the temperature display flashes.	Has the appliance door been open for longer than 60 seconds? If not, then the temperature has risen higher or fallen lower than the temperature that has been set. This could be due to: The appliance door being opened too often. The ventilation opening being covered or too dusty. A lengthy interruption in the power supply. A large amount of food has been added to the unit.	If yes, close the door.  Do not open the door more often than necessary. Clear the obstructions and clean the dust. Leave the appliance to work for a while until the set temperature has been reached.

## **Warranty Information**

### LIMITED WARRANTY

Manufacturer warrants to the original purchaser at the original site of delivery with proof of purchase of each Refrigerator that when subject to normal residential use, it is free from defects in workmanship and material for the periods specified below. This warranty excludes refrigerators used in rental or commercial applications. It does not cover labor or labor related charges. There will be shipping and handling charge for the delivery of the warranty part(s).

#### ***1 Year Warranty***

Our obligation under this warranty is limited to repair or replacement, at our option, of the product during the warranty period. The extent of any liability of Manufacturer, under this warranty is limited to repair or replacement. This warranty does not cover normal wear of parts, damage resulting from any of the following: negligent use or misuse of the product, use contrary to operating instructions, or alteration by any person other than our factory service center. The warranty period is not extended by such repair or replacement.

**Warranty claim procedure:** If you require parts for your refrigerator, please contact our Customer Service Center for factory direct assistance. Customer Service can be reached via phone, 1-866-976-9510, or email at CustomerService@BlazeGrills.com. Please direct all correspondence to: BLAZE OUTDOOR PRODUCTS, 6620 Greenwell Springs Rd, Baton Rouge, LA 70805. ATTN: Warranty Service Center

**ATTENTION International Customers:** Please consult your selling dealer or distributor for specifics pertaining to your product warranty and procedure.

Product repair as provided under this warranty is your exclusive remedy. Manufacturer shall not be liable for any incidental or consequential damages for breach of any express or implied warranty on its products. Except to the extent prohibited by applicable law, any implied warranty or merchantability or fitness for a particular purpose on this product to the duration of the above warranty. Some states do not allow the exclusion or limitation of incidental or consequential damages, or allow limitations on how long an implied warranty lasts, so the above limitations or exclusions may not apply to you. This warranty gives you specific legal rights, and you may have other rights, which vary from state to state.