

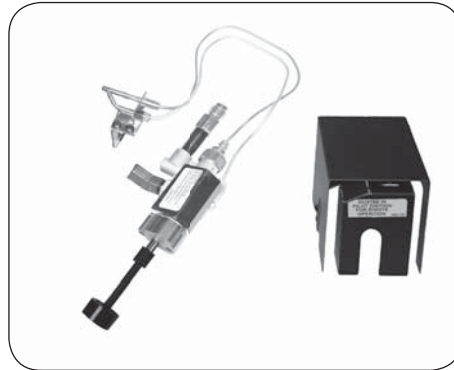

**AUTOMATIC REMOTE LIGHTING SAFETY PILOT SYSTEM  
WITH VARIABLE FLAME-HEIGHT REMOTE  
FOR NATURAL OR PROPANE GAS**

**Models:  
APK-17(M)(P)**



**FEATURES:**

- CONTROL OPERATED ON/OFF •
- VARIABLE FLAME-HEIGHT REMOTE •
- VARIABLE FLAME HEIGHT CONTROL •
- STANDING PILOT •

**SUITABLE FOR THE FOLLOWING BURNERS:**

- PAN BURNERS (P-SERIES) •
- G4 SERIES BURNERS •
- G45 SERIES BURNERS •

## APK-17 PILOT KITS

### WARNING

If the information in this manual is not followed exactly, a fire or explosion may result, causing property damage, personal injury, or loss of life.

Do not store or use gasoline or other flammable vapors and liquids in the vicinity of this or any other appliance.

#### **WHAT TO DO IF YOU SMELL GAS:**

- Open a window.
- Do not try to light any appliance.
- Do not touch any electrical switch; do not use any phone in the building.
- Immediately call the gas supplier from a neighbor's phone and follow the gas supplier's instructions.
- If you cannot reach the gas supplier, call the fire department.

**Installation and service must be performed by an NFI Certified or other qualified professional installer, service agency, or the gas supplier.**

#### **INSTALLER & CONSUMER**

These instructions **MUST** be retained with this appliance

**Important:** Read these instructions carefully before starting installation of the burner control system.

The Peterson Real Fyre burner system is to be installed only in a solid-fuel-burning fireplace with a working flue constructed of noncombustible material. Solid fuels shall not be burned in a fireplace where the unit is installed. The installation, including provisions for combustion, ventilation air, and required minimum permanent vent opening, must conform with the *National Fuel Gas Code (ANSI Z223.1/NFPA 54)* and applicable local building codes. In Canada, the installation must conform with the *Natural Gas and Propane Storage and Handling Installation Code (CSA-B-149.1)*. A damper stop clamp is included to maintain the minimum permanent vent opening and to prevent full closure of the damper blade. **The chimney damper must be fixed fully opened when burning the unit. The burner system is designed to burn with yellow flames; thus, adequate ventilation is absolutely necessary.**



# TABLE OF CONTENTS

## GETTING STARTED

IMPORTANT INFORMATION.....	3
SPECIFICATIONS.....	3
NOTES PAGE.....	4
REPLACEMENT PARTS LIST.....	5

## INSTALLATION

INSTALLATION.....	6
<i>PREPARATION</i> .....	6
<i>CONVERTING FOR DIFFERENT GAS TYPE</i> .....	6
<i>INSTALL VALVE</i> .....	6
<i>INSTALL FLAME DIVERTER BRACKET</i> .....	7
<i>INSTALL PILOT ASSEMBLY TO BURNER</i> .....	7
<i>CONNECT TO GAS SUPPLY</i> .....	8
<i>CONNECT REMOTE RECEIVER (if equipped)</i> .....	9
<i>HEAT SHIELD PLACEMENT</i> .....	9
<i>DECORATIVE MEDIA REPLACEMENT</i> .....	9

## USE, CARE, & SERVICE

LIGHTING INSTRUCTIONS - 17 SERIES.....	10
<i>LIGHTING THE PILOT</i> .....	10
<i>REMOTE LIGHTING (if equipped)</i> .....	10
<i>MANUAL LIGHTING</i> .....	11
<i>SHUTTING DOWN</i> .....	12
<i>PILOT BURNER CHECK/ADJUSTMENT</i> .....	12
REMOTE OPERATING INSTRUCTIONS - 17 SERIES.....	12
<i>ORIENTATION</i> .....	12
<i>FLAME HEIGHT</i> .....	12
TROUBLESHOOTING.....	13
SYNCING THE REMOTE SYSTEM.....	13
<i>SYNCING THE REMOTE SYSTEM</i> .....	13
WARRANTY.....	14

## IMPORTANT INFORMATION

### CHECK TO BE SURE THAT THE PROPER FUEL GAS IS BEING USED WITH THIS PILOT KIT.

The installation, including provisions for combustion and ventilation air, must conform with local codes, or in the absence of local codes, with the National Fuel Gas Code (ANSI Z223.1/NFPA 54).

This component and its individual shutoff valve must be disconnected from the gas-supply piping system when testing at pressures that exceed 1/2 psig. This is accomplished by closing the gas-supply line valve.

This component must be isolated from the gas-supply piping system by closing its individual manual shutoff valve during any testing of the gas-supply system at test pressures up to and including 1/2 psig.

A fireplace screen must be in place when the gas burner system is in operation. Unless other provisions for combustion air are provided, the screen shall have an opening(s) for introduction of combustion air.

### WHEN GLASS FIREPLACE ENCLOSURES (DOORS) ARE USED, OPERATE THE BURNER SYSTEM WITH THE GLASS DOORS FULLY OPEN; BOTH SIDES IF THE FIREPLACE IS A SEE-THROUGH TYPE.

This appliance may be installed in an aftermarket, permanently located, manufactured (mobile) home where not prohibited by local codes. Installation of appliances designed for manufactured homes or mobile homes must conform with *Manufactured Home Construction and Safety Standard, Title 24 CFR, Part 3280* in the U.S.; or with *CAN/CSA Z240 MH* in Canada; or with *ANSI/NCSBCS A225.1/NFPA 501A, Manufactured Home Installations Standard* when such as standard is not applicable.

Do not use this appliance if any part has been underwater. Immediately call a qualified service technician to inspect the appliance and to replace any part of the control system and any gas control that has been underwater.

#### **TO PREVENT VALVE DAMAGE AND FAILURE:**

**IT IS CRITICAL THAT THE HEAT SHIELD BE PLACED CORRECTLY OVER THE VALVE PRIOR TO OPERATION.**

**KEEP LAVA GRANULES/COALS, SAND/VERMICULITE, EMBERS/GLASS, AND ALL FOREIGN OBJECTS AWAY FROM THE PILOT ASSEMBLY, VALVE ASSEMBLY, AND HEAT SHIELD DURING MEDIA PLACEMENT AND AT ALL TIMES.**

## SPECIFICATIONS

Refer to the burner owner's manual for minimum firebox dimensions.

Model	BTUs	
	Nat.	L.P.
APK-17	100 k	200 k

Table 1 - Maximum BTUs

# NOTES PAGE

Please use this page to record any information that you may want to have at hand.

# APK-17 REPLACEMENT PARTS LIST

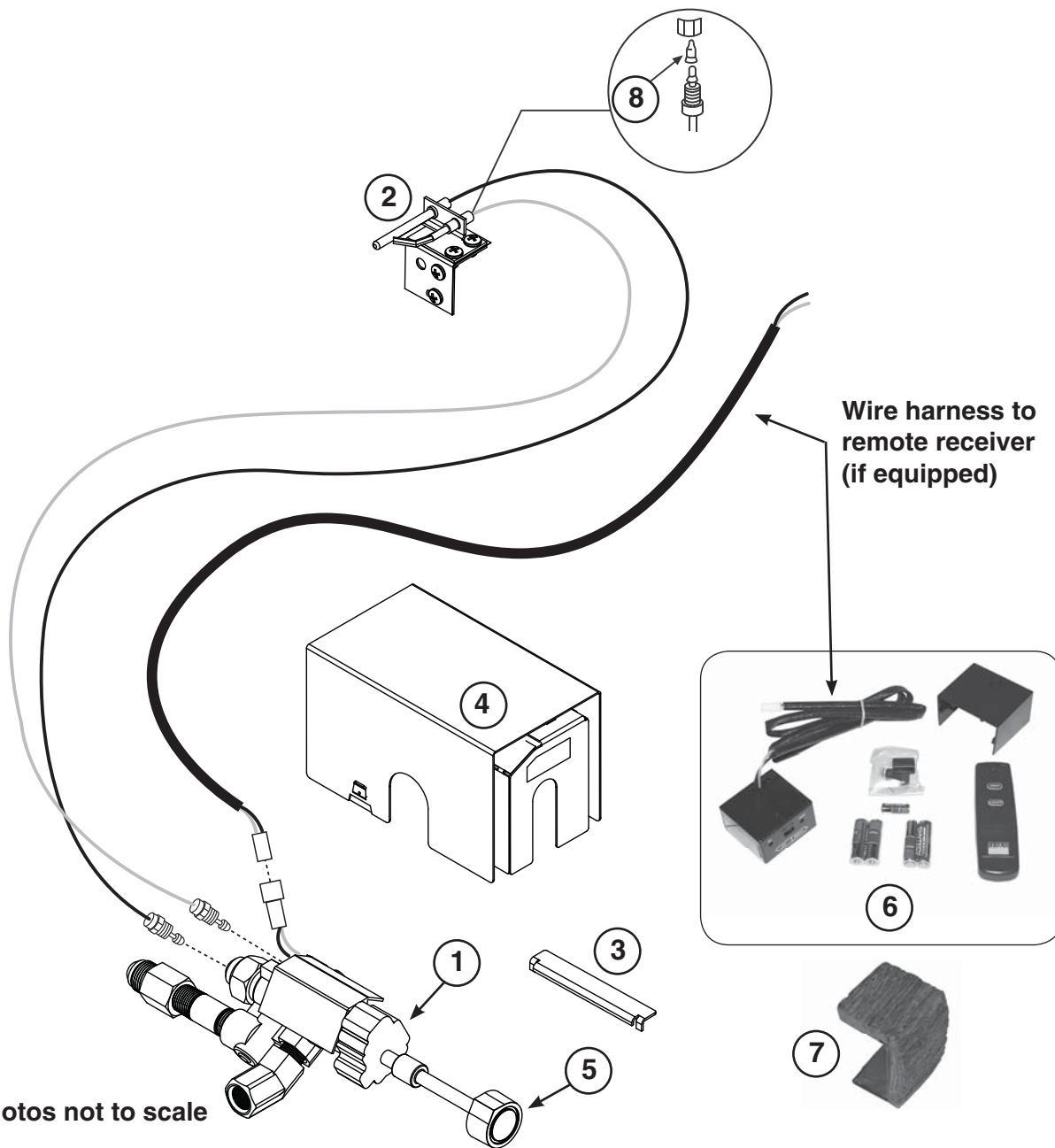

Note: Photos not to scale

Item	Description	Part No.	Qty.
1.	Control valve (natural or propane)	SV-37	1
2.	Pilot assembly (natural)	PAC-1NAT	1
or	Pilot assembly (propane)	PAC-1LP	1
3.	Flame diverter bracket	SH-1	1
4.	Valve heat shield	HS-35	1
5.	Control knob w/ extension	EH-11H	1
6.	Remote kit (if equipped)	VR-1A	1
7.	Decorative heat shield (if equipped)	HS-36	1
8.	Nat. gas orifice	PBO-20	1
or	L.P. gas orifice	PBO-10	1

# INSTALLATION

**This safety pilot system must be installed by a qualified professional service technician. Instructions must be followed carefully when installing to ensure proper performance and full benefit from the burner system and safety pilot system.**

These instructions must be used as a supplement to the instructions supplied with the R.H. Peterson burner system. Follow the burner system instructions and make adjustments as appropriate for the addition of a safety pilot system. Use gas pipe sealing compound that is resistant to all gasses (or Teflon tape) and apply to all male pipe connections. DO NOT apply pipe sealing compound to any flare connections. Make sure that all connections are tight.

The valve system is shipped pre-assembled for easy installation onto the burner pan.

**Note:** Installation is easier when done outside of the fireplace.

## PREPARATION

If the burner that the valve system is to be added to is already installed; remove all decorative media, set aside to be reinstalled later, and disconnect the flex connector and adapter from the burner pan (using the instructions that came with the original burner).

## CONVERTING FOR DIFFERENT GAS TYPE

**CAUTION:** Check to be sure this pilot kit is designed and labeled for the type of gas (natural or propane gas) supplied to the fireplace.

The safety pilot kit may require a pilot orifice conversion. Replace the existing gas orifice with the opposite gas orifice (contained in the envelope marked "L.P. GAS" or "NAT GAS") by carefully removing the pilot gas supply line. Re-attach the pilot gas supply line to the pilot when done. Reference Fig. 6-1.

**CAUTION:** During any conversions, all components must be set/converted for the appropriate gas type (i.e. burner orifice, regulator, etc.). Contact your dealer and a qualified professional service technician.

## INSTALL VALVE

1. Apply gas pipe sealing compound (or Teflon tape) to the male end of the fuel injector or air mixer on the burner.
2. Install the valve to the fuel injector or air mixer by screwing the pan into the valve (Fig. 6-2). Take care not to damage the attached pilot assembly when rotating the burner pan. Be sure all connections are tight, however do not overtighten to prevent damage to the valve.

**Important:** Ensure the bottom of the control knob is at least 3/4" above the floor. See Fig. 6-3.

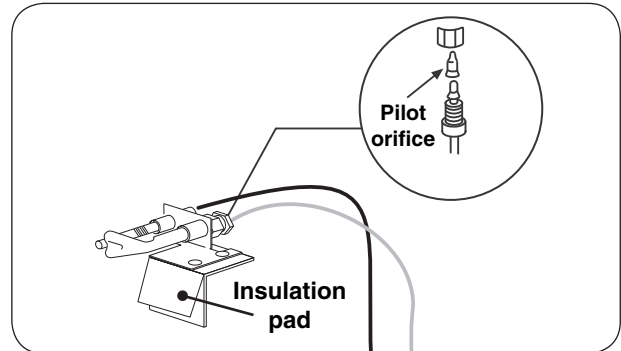

**Fig. 6-1** Pilot conversion (only if applicable)

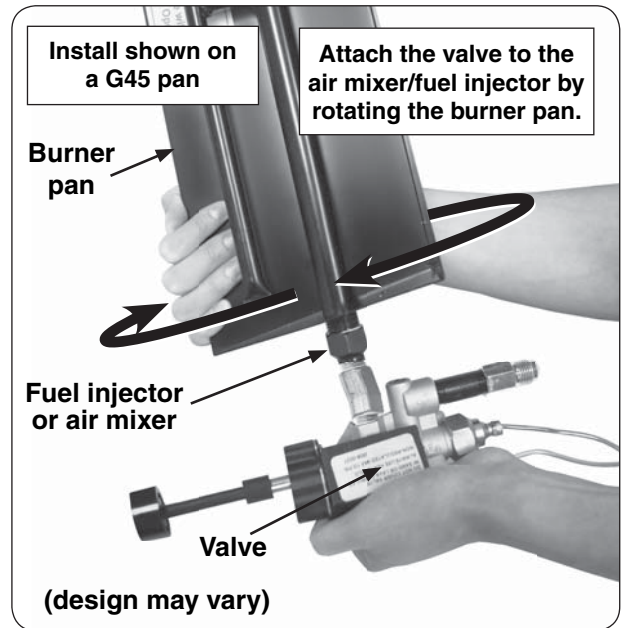

**Fig. 6-2** Install valve

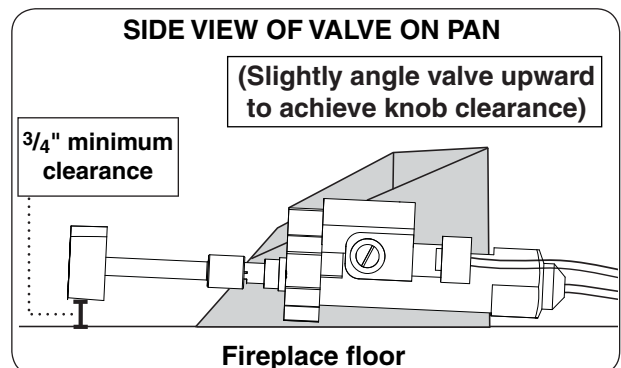

**Fig. 6-3** Ensure knob clearance

## INSTALL FLAME DIVERTER BRACKET

For installation on G4/G45 burners only. When properly installed onto the burner pan, the flame diverter bracket will promote quicker ignition and protect the safety control system from overheating.

**Note:** You must first install the flame diverter bracket before installing the pilot/igniter assembly.

1. Place the flame diverter bracket over the side edge of the burner pan, near the location the safety control system pilot bracket will be attached. It should be placed **approximately 1-1/4"** from the rear wall of the burner pan (see Fig. 7-1).
2. Tap the bracket lightly with a rubber mallet to secure it in place.

## INSTALL PILOT ASSEMBLY TO BURNER

**CAUTION:** Use only the pilot assembly pre-assembled with this kit. Never substitute with an existing pilot.

**CAUTION:** Do not kink or damage the pilot supply line and thermocouple tube. Do not unscrew the gas line from the valve.

1. The pilot assembly comes with two Phillips screws installed on the long side of the pilot bracket. Remove the screws and use them to fasten the pilot assembly to the burner pan using the pre-drilled holes in the pan (see Fig. 7-2 and Fig. 7-3).

**Note:** Ensure the insulation is properly in place between the pilot bracket, burner pan, and pilot assembly. Screw from the inside of burner pan.

2. Ensure the pilot supply line and thermocouple tube are bent in a similar manner as shown in Fig. 7-3 to prevent damage / unsafe operation, and to allow for proper heat shield placement. Maintain this orientation at all times.

**WARNING:** Keep the pilot assembly clear at all times. Never cover any part of the pilot assembly.

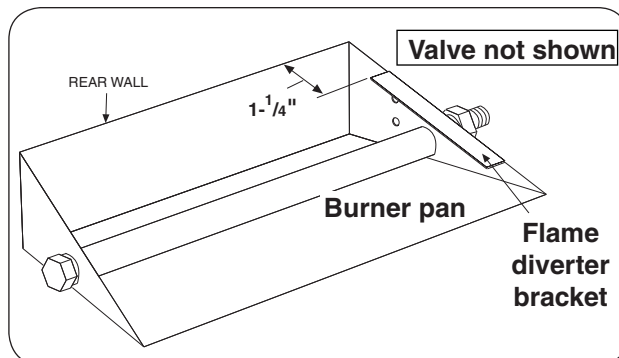

**Fig. 7-1** Install diverter bracket (if applicable)

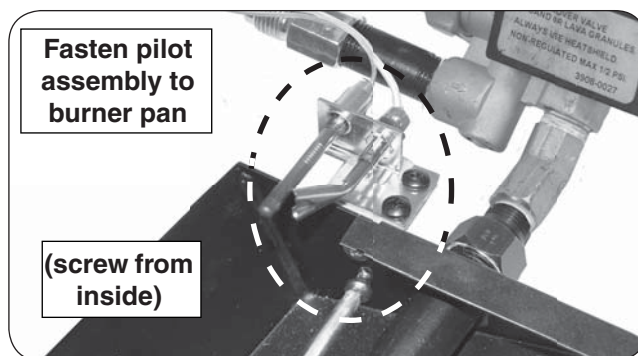

**Fig. 7-2** Install pilot assembly

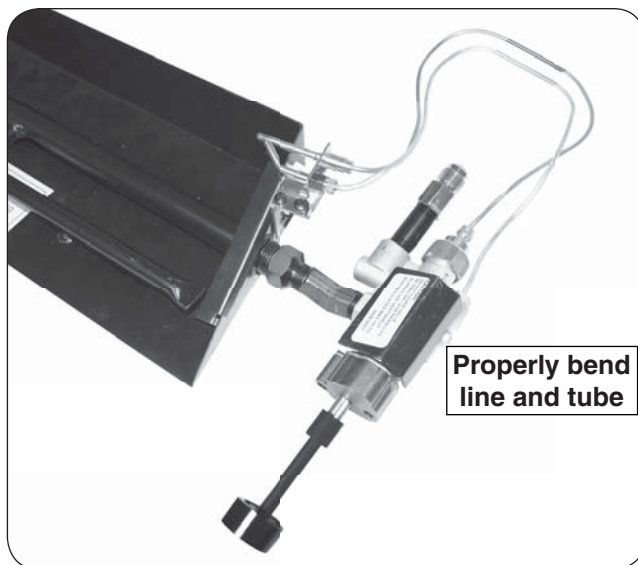

**Fig. 7-3** Proper line and tube orientation

### CONNECT TO GAS SUPPLY

To connect the valve to the gas supply, the flex connector kit and component parts will be needed, which are included with the burner system. Refer to the PARTS LIST in the instructions supplied with the burner to identify the key parts needed.

1. MAKE SURE THE FIREPLACE GAS SUPPLY IS TURNED OFF.
2. Locate the gas-supply stub inside the fireplace and remove the cap, if attached.

**CAUTION:** When removing the cap, make sure the stub does not turn, loosening the connection inside the wall.

3. Locate the burner flex connector kit. Discard the small adapter included with the kit. Then attach the open end of the connector to the small adapter found on the control valve. Tighten securely. See Fig. 8-1.
4. Place the burner system in the fireplace. Center the burner in the fireplace.
5. **Be sure gas to the fireplace is off.** Attach the large adapter (included with burner flex connector kit) to the gas-supply stub using a pipe compound resistant to all gasses. Tighten securely. Then attach the open end of the flex connector to the large adapter. Tighten securely.
6. LEAK TEST: Turn on the fireplace gas supply, and test at all connections for leaks using the appropriate soapy water solution. If bubbles appear, a leak is present. Turn off the gas and tighten at all connections. Repeat until no leaks are present. If a leak persists, turn off the gas supply and contact the local gas company or dealer. NEVER USE A FLAME TO CHECK FOR LEAKS.
7. Follow the instructions supplied with the Peterson burner system for any additional requirements regarding specific burner setup and placement.

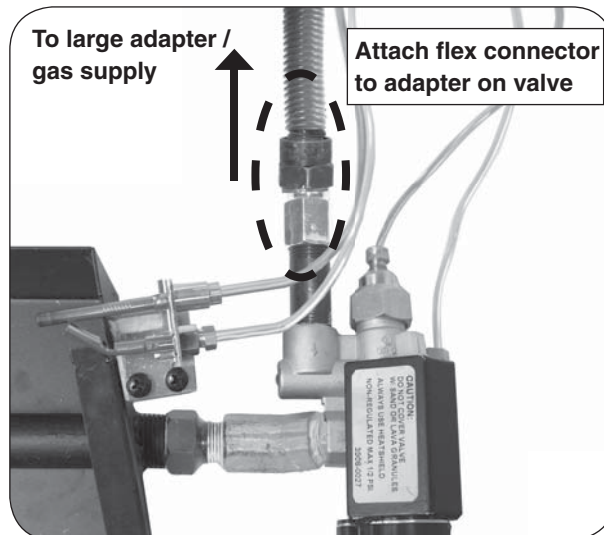

**Fig. 8-1** Install flex connector to valve



## CONNECT REMOTE RECEIVER (if equipped)

**Note:** Discard the black wires that come with the remote receiver.

1. Install the provided batteries in the remote transmitter and receiver.
2. Place the receiver as far from the burner system as possible (see Fig. 9-1).

**Note:** Place the receiver a minimum of 6" from the burner/flame.

3. Place the plastic cover over the remote receiver with the open side facing front to allow access to the receiver controls (see Fig. 9-1).
4. Place the decorative heat shield over the remote receiver (see Fig 9-2).
5. Ensure the remote receiver wire harness is properly connected to the valve as shown in Fig. 9-3.

## HEAT SHIELD PLACEMENT

### TO PREVENT VALVE DAMAGE AND FAILURE:

**IT IS CRITICAL THAT THE HEAT SHIELD BE PLACED CORRECTLY OVER THE VALVE PRIOR TO OPERATION.**

### TO PREVENT OVERHEATING THE VALVE:

Cover the valve with the heat shield as shown in Fig. 9-4 and Fig. 9-5. It should rest flat above the valve.

**Keep the area above and below the heat shield clear of decorative media or any other objects at all times.**

**Important: Ensure the pilot supply line and thermocouple tube do not interfere with heat shield placement.**

**Important:** Keep lava granules/coals, sand/vermiculite, embers/glass, and all foreign objects away from the pilot assembly, valve assembly, and heat shield during media placement and at all times.

APK-17 installation is complete at this point. Ensure ALL information in this manual is followed to ensure proper operation.

## LIGHTING TEST

Prior to proceeding with installation, perform a lighting test (see lighting instructions for lighting your burner). **Allow the unit to completely cool after testing.**

## DECORATIVE MEDIA REPLACEMENT

Refer to the burner instructions for proper placement of decorative media.

**Important:** Keep lava granules/coals, sand/vermiculite, embers/glass, and all foreign objects away from the pilot assembly, valve assembly, and heat shield during media placement and at all times.

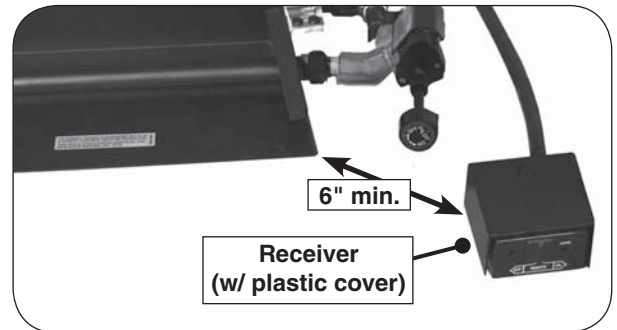

**Fig. 9-1** Place receiver away from burner

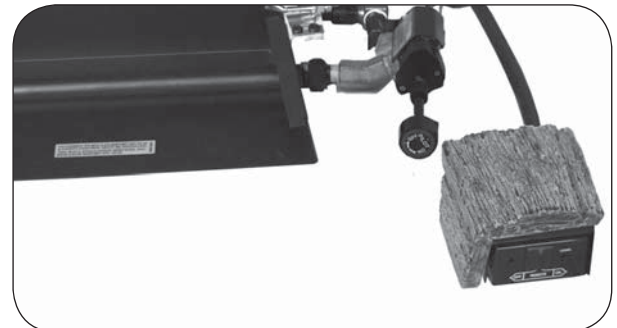

**Fig. 9-2** Place decorative heat shield

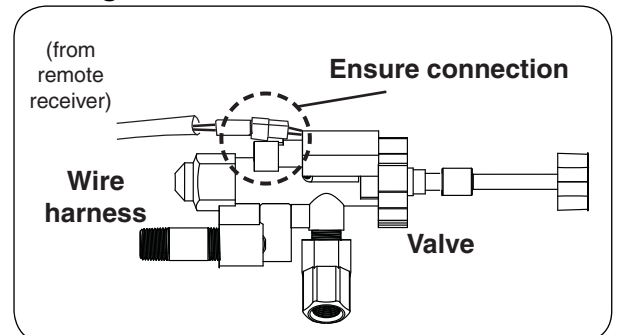

**Fig. 9-3** Ensure harness connection

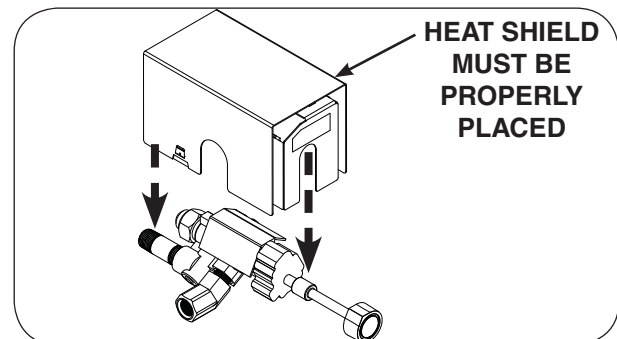

**Fig. 9-4** Place heat shield

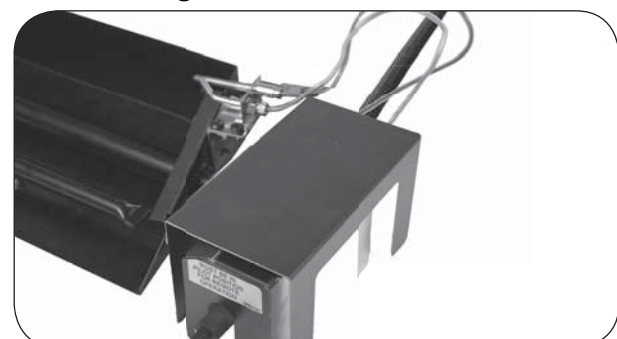

**Fig. 9-5** Heat shield properly placed

# LIGHTING INSTRUCTIONS - 17 SERIES

## FOR YOUR SAFETY READ BEFORE LIGHTING

**WARNING:** If you do not follow these instructions exactly, a fire or explosion may result causing property damage, personal injury or loss of life.

- A. Use only your hand to push in or turn the gas control knob. Never use tools. If the knob will not push in or turn by hand, don't try to repair it. Call a qualified professional service technician. Excessive force or attempted repair may result in fire or explosion.
- B. **BEFORE OPERATING**, smell all around the appliance area for gas. Be sure to smell next to the floor because some gas is heavier than air and will settle on the floor.

### WHAT TO DO IF YOU SMELL GAS

- Do not light any appliance.
  - Do not touch any electric switch; do not use any phone in your building.
  - Immediately call your gas supplier from a neighbor's phone. Follow the gas supplier's instructions. If you cannot reach your gas supplier, call the fire department.
- C. The burner system has a pilot that can be lit by hand using a match or long-necked lighter. When lighting the pilot, follow these instructions exactly.
  - D. Do not use this appliance if any part has been under water. Immediately call a qualified service technician to inspect the appliance and to replace any part of the control system and any gas control which has been under water. Attempted operation may result in fire or explosion resulting in property damage, personal injury or loss of life.

### LIGHTING THE PILOT

1. Locate the valve on the side of the unit. Push in the gas control knob slightly and turn clockwise to **OFF** (Fig. 10-1).

**Note:** The control knob cannot be turned from **PILOT** to **OFF** unless the knob is pushed in slightly. Do not force.

**Allow five (5) minutes for any gas in the unit to dissipate. IF YOU SMELL GAS, SEE STEP B ABOVE.** If you don't smell gas, go on to step 2.

2. Turn the control knob counterclockwise to **PILOT** (Fig. 10-1). Push the control knob **firmly and fully** in and hold. Hold a long fireplace match or lighter near the thermocouple to light the pilot. Continue to hold the control knob in for approximately 60 seconds after the pilot is lit, then release the knob. The pilot will remain lit.

**WARNING:** If the pilot fails to light repeat steps 1 and 2.

If the pilot fails to light after several tries, turn the control knob to **OFF** and contact a qualified professional service technician.

### REMOTE LIGHTING (if equipped)

**Note:** If the remote does not function, and batteries with an adequate power level are installed, refer to the SYNCING THE REMOTE section.

**Note:** Step 1 may not be required if previously done during an earlier lighting.

1. Ensure the pilot is burning. Then locate the 3-position switch on the remote receiver (see Fig. 10-2), and slide the switch to the **REMOTE** position.

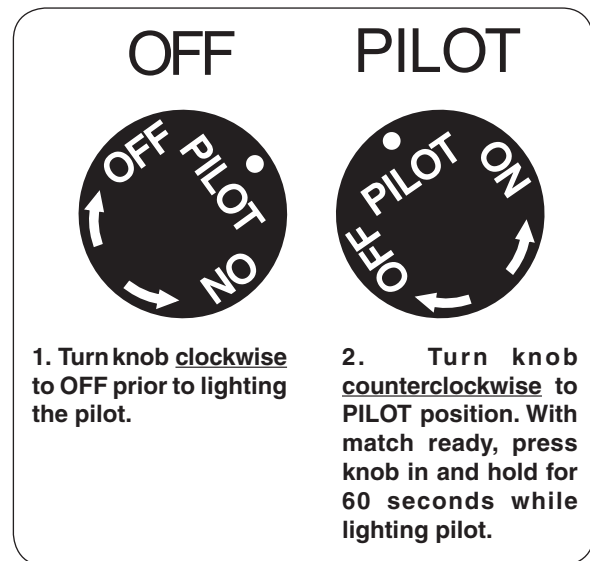

Fig. 10-1 Control knob detail (OFF, PILOT)

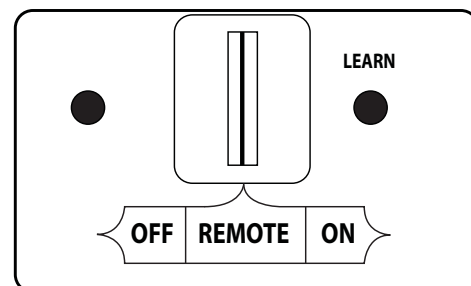

Fig. 10-2 Remote receiver detail (REMOTE)

## LIGHTING INSTRUCTIONS - 17 SERIES (cont.)

2. Locate the remote transmitter and press and hold the **ON/HI** button (see Fig. 11-1). The ignition sequence will begin.

**Note:** Continue holding the button to increase the flame. A click will be heard when max flame height is reached.

**Note:** Upon initial use or after an extended period of no use, the **ON/HI** button may have to be pressed for up to 3 seconds prior to functioning.

The remote receiver will emit an audible "beep"; then the valve will automatically open and the burner will light. Adjust to the desired setting(s) with the remote transmitter. See the REMOTE OPERATING INSTRUCTIONS section for details.

**Note:** The ignition sequence will take approximately 5 seconds.

**WARNING:** If the burner fails to light within 5 seconds, press and hold the **OFF** button on the remote transmitter and/or slide the switch to the **OFF** position. Allow five (5) minutes for any gas in the unit to dissipate, then repeat steps 1 and 2 above. **IF YOU SMELL GAS, SEE STEP B AT BEGINNING OF LIGHTING INSTRUCTIONS.**

If the burner fails to light after several tries, turn all system components to **OFF** and contact a qualified professional service technician.

### MANUAL LIGHTING

1. Ensure the pilot is burning. If equipped, locate the 3-position switch on the remote receiver (see Fig. 11-2), and slide the switch to the **OFF** position.
2. Turn the gas control knob counterclockwise to **ON** (Fig. 11-3) to ignite the burner. The valve will open and the burner will light.

**Note:** The ignition sequence will take approximately 5 seconds.

**WARNING:** If the burner fails to light within 5 seconds, turn the control knob clockwise to **PILOT**. Allow five (5) minutes for any gas in the unit to dissipate, then repeat step 2 above. **IF YOU SMELL GAS, SEE STEP B AT BEGINNING OF LIGHTING INSTRUCTIONS.**

If the burner fails to light after several tries, push in the control knob slightly and turn clockwise to **OFF**, and contact a qualified professional service technician.

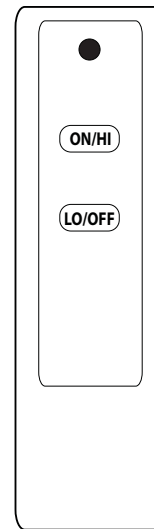

Fig. 11-1 Remote transmitter detail

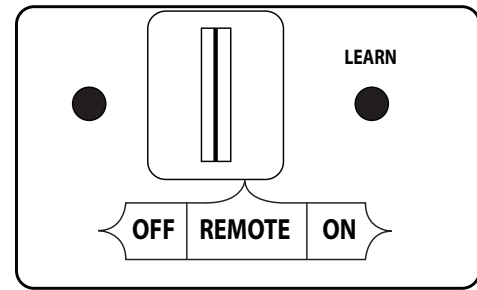

Fig. 11-2 Remote receiver (OFF for Manual Light)



Fig. 11-3 Control knob detail (ON)

## LIGHTING INSTRUCTIONS - 17 SERIES (cont.)

### SHUTTING DOWN

#### **MAIN BURNER ONLY (pilot will remain lit):**

For remote shut down, press and hold the **LO/OFF** button on the remote transmitter until the burner shuts off. **If remote is unavailable**, slide the switch on the receiver to the **OFF** position. For manual shutdown, turn the control knob clockwise to **PILOT**.

#### **BURNER AND PILOT (total shutdown):**

If you do not plan on using your burner system for an extended period (one week or more), **you may extinguish the pilot**. This will conserve energy and save you money.

Push in the control knob slightly and turn clockwise to **OFF**.

### PILOT BURNER CHECK/ADJUSTMENT

With the pilot burner lit and the control knob in the pilot position, check the pilot system for proper flame size and appearance (see Fig. 12-1). The pilot adjustment screw is located on the front of the gas valve (see Fig. 12-1). Using a small flat head screwdriver, adjust the pilot screw to properly size the flames. Turning the screw clockwise will lower the flames, and turning it counterclockwise will raise them. Be careful not to back the screw out of its threads.

The pilot flame should be a quiet, soft blue flame with yellow tipping that encircles the thermocouple tip.

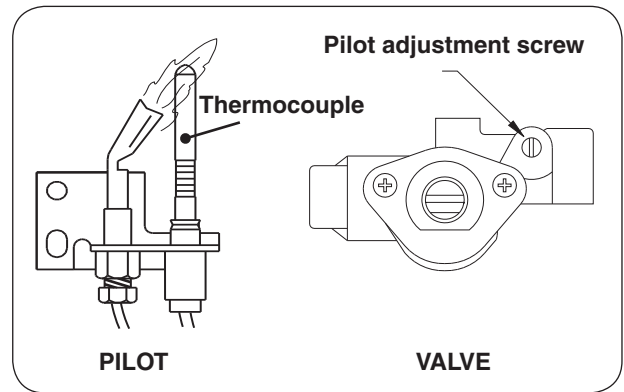

Fig. 12-1 Pilot adjustment detail

## REMOTE OPERATING INSTRUCTIONS - 17 SERIES

### ORIENTATION

**Note:** If the remote does not function, and batteries with an adequate power level are installed, refer to the SYNCING THE REMOTE section.

Prior to remote transmitter use, light the appliance per the REMOTE LIGHTING section. Familiarize yourself with the transmitter buttons, as illustrated in Fig. 12-2.

Identify the transmitter buttons:

- **ON/HI BUTTON:** This button turns the burner ON (when the pilot is lit), and increases the flame height.
- **LO/OFF BUTTON:** This button decreases the flame height and turns the burner OFF (pilot will remain lit).

### FLAME HEIGHT

The flame height may be adjusted via the remote transmitter. Press and hold the **ON/HI** button to increase the flame height. Press and hold the **LO/OFF** button to decrease the flame height. A click will be heard when the max/minimum setting is reached.

**Note:** Continuing to hold the **LO/OFF** button will turn off the burner. The pilot will remain lit.

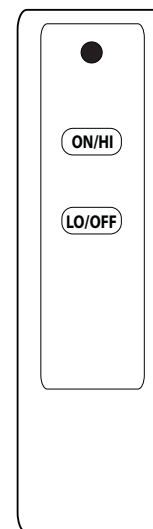

Fig. 12-2 Remote transmitter detail

## TROUBLESHOOTING

PROBLEM	CAUSE	SOLUTION
1. Pilot will not light	<ul style="list-style-type: none"> <li>a. Obstruction in pilot gas supply or pilot gas-supply line is kinked</li> <li>b. Inadequate gas supply</li> <li>c. Air in line</li> </ul>	<ul style="list-style-type: none"> <li>a. Clear out obstruction. Replace pilot gas-supply line if kinked</li> <li>b. Have gas pressure checked by installer or gas supplier</li> <li>c. Air should clear; attempt to relight</li> </ul>
2. Pilot will not stay lit after releasing knob	<ul style="list-style-type: none"> <li>a. Thermocouple connection to valve either too tight or too loose</li> <li>b. Bad thermocouple</li> </ul>	<ul style="list-style-type: none"> <li>a. Thermocouple should be finger tight and then 1/8" turn with a wrench</li> <li>b. Replace thermocouple</li> </ul>
3. Burner system extinguishes a few minutes after lighting	<ul style="list-style-type: none"> <li>a. Inadequate gas supply causes pilot flame to reduce after burner lights</li> </ul>	<ul style="list-style-type: none"> <li>a. Using pilot adjustment, increase gas to pilot. Pilot flame must be in contact with the thermocouple tip.</li> </ul>
4. Burner system extinguishes after burning for some time (approximately 10 minutes to 1 hour)	<ul style="list-style-type: none"> <li>a. Thermocouple has overheated; glass doors are closed</li> <li>b. Thermocouple has overheated; insulation pad is not in place</li> <li>c. Thermocouple has overheated; burner flames are heating the thermocouple cold junction</li> </ul>	<ul style="list-style-type: none"> <li>a. Be sure glass doors are open during operation</li> <li>b. Be sure that the insulation pad is in place between the burner pan and the pilot bracket</li> <li>c. Be sure the pilot assembly and the flame diverter are in their proper position. Re-arrange logs so that flame is not deflected to the thermocouple.</li> </ul>
5. Valve will not turn "OFF" with remote	<ul style="list-style-type: none"> <li>a. Valve over heated</li> <li>b. Low batteries</li> </ul>	<ul style="list-style-type: none"> <li>a. Ensure that the valve heat shield is properly placed and no gas leaks are present at the valve gas fittings</li> <li>b. Replace batteries in remote receiver</li> </ul>

## SYNCING THE REMOTE SYSTEM (IF APPLICABLE)

### SYNCING THE REMOTE SYSTEM

Ensure the burner system is off and completely cool.

Locate the 3-position switch on the remote receiver and slide it to the **REMOTE** position. Use the tip of a pen or a wire clip to push the **LEARN** button and release. See Fig. 13-1. A beep will be heard. Then press and hold the **ON/HI** button on the remote transmitter; a series of beeps should be heard. The remote system is now synced. Refer to the LIGHTING INSTRUCTIONS to test.

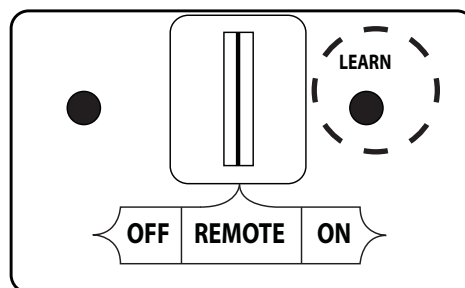

**Fig. 13-1** Remote receiver sync detail

# WARRANTY

## PETERSON VENTED DECORATIVE GAS APPLIANCE LIMITED WARRANTY

Robert H. Peterson Co. ("RHP") warrants your Real Fyre® vented decorative gas appliance to be free from defects in material and workmanship.

Peterson vented ceramic refractory gas logs are warranted for **as long as you own them (lifetime)**.

Peterson vented burner assemblies are **WARRANTED for TEN (10) YEARS**. Peterson vented outdoor stainless-steel burner assemblies are warranted for **FIVE (5) YEARS**.

Peterson glass, gems, nuggets, and fiber-ceramic blend gas logs are warranted for **FIVE (5) YEARS**.

SPK-26 controls are warranted for **THREE (3) YEARS**.

APK-17 controls (including -17 valve) are warranted for **TWO (2) YEARS**.

All other Peterson valves, pilots, and controls are warranted for **ONE (1) YEAR (excluding batteries)**.

### A COPY OF YOUR SALES SLIP FOR PROOF OF PURCHASE IS REQUIRED

This warranty applies to the original purchaser for products which are installed in the United States or Canada and which are operated and maintained as intended for single family residential usage. This warranty is valid only with proof of purchase, shall commence on the date of purchase, and shall terminate (both as to original and any replacement products) on the anniversary date of the original purchase of the product stated on the above schedules.

This warranty covers defects in material and workmanship. This warranty **does not** cover parts which become defective as a result of negligence, misuse, use not in compliance with the Owner's Manual/Installation Instructions, accidental damage, improper handling, improper storage, improper installation, **lack of required routine maintenance** (as specified in the Owner's Manual/Installation Instructions), electrical damage, local gas impurities or failure to protect against combustibles. Product must be installed (and gas must be connected) as specified in the Owner's Manual/Installation Instructions by a **qualified professional installer**. Modifications to products which are not specifically authorized will void this warranty. Accessories, parts, valves, remotes, etc. when used must be Peterson products or this warranty is void. Warranted items will be repaired or replaced at Peterson's sole discretion. This warranty **does not** apply to rust, corrosion, oxidation, or discoloration unless the affected part becomes inoperable.

This warranty **does not** cover labor or labor related charges, except as provided by separate specific written programs from the Peterson Co. All repair work must be performed by a qualified professional service person and requires prior approval of Peterson.

Peterson may require the defective product or part to be returned to the factory to determine the cause of failure. Peterson will pay freight charges if the product or part is determined to be defective. This warranty does not cover breakage in shipment from our (Independent) distributor to its customer if the damage is determined to have occurred during that shipment.

This warranty specifically excludes liability for **indirect, incidental**, or consequential damages. Some states and provinces do not allow the exclusion or limitation of incidental or consequential damages, so the above exclusion may not apply to you. This warranty gives you specified legal rights, and you may have other rights that vary from state to state or province.

For additional information regarding this warranty, or to place a warranty claim, contact the R. H. Peterson dealer where the product was purchased.

When contacting your Peterson dealer or the R. H. Peterson Co., please provide the following information:

- Your name, address, telephone number, e-mail
- Sales receipt showing where purchased and date purchased
- Model number, serial number of product, date code
- Relevant information: installer, additions, repairs, when defect was first noted

**TO REGISTER YOUR PRODUCT ONLINE GO TO: [WWW.RHPETERSON.COM](http://WWW.RHPETERSON.COM),  
AND CLICK ON PRODUCT REGISTRATION. THANK YOU FOR YOUR PURCHASE.**

<b>Quality Check</b>		<b>Date:</b> _____	
<b>Leak Test:</b> _____	<b>Burn Test:</b> _____	<b>Gas Type:</b> _____	<b>Nat. / L.P.</b>
<b>Inspector:</b> _____			