

2024 / PRODUCT CATALOGUE

PREMIUM QUALITY FOR ALL BOATS

Outdoor Instrumentation engineered in Switzerland



**CUTTING EDGE
TECHNOLOGY,
HIGH-QUALITY DESIGN,
PREMIUM MATERIAL.
DISCOVER THE
LATEST VERATRON
MARINE PRODUCTS.**



**DISCOVER
MORE**



CONTENT

	COMPANY / Veratron	04
	VMH SERIES / Introduction	10
	VMH Flex, VMH 35	12
	VMH 70	13
	VMH 14, VMH 35-D	14
	OCEANLINK™ / Introduction	16
	TFT Displays	18
	85 mm Master Gauges	19
	52 mm Gauges	20
	VIEWLINE / Introduction	24
	VL Flex Series	26
	ViewLine 110mm Gauges	28
	ViewLine 85 mm Gauges	29
	ViewLine 52 mm Gauges	31
	NAVIGATION / Mast Display Units	35
	TFT Displays	36
	OceanLink™ Navigation, Rudder Indicator	36
	NavControl and NavBox	37
	NavSensor	38
	Wind Sensor	38
	Veratron GO	39
	ECU / EngineBox	41
	LinkUp Series	42
	SENSORS / Sensors	47
	KITS / IBM 12 and 24V	53
	VMH 35 outboard engine	53
	Smart Kit 7 and 4.3	54
	Navigation Kit	54
	Sailing Kit	55
	ACCESSORIES / AcquaLink™ and OceanLink™ Accessories	56
	CAN Bus, AcquaLink™ and OceanLink™	
	Installation Accessories	57
	ViewLine Accessories	58
	Sensors Accessories	59

**Premium outdoor instrumentation
engineered in Switzerland.**

/

VERATRON

LEADING SOLUTIONS FOR DEMANDING INSTRUMENTATION

The first choice in the marine business.

Veratron was established to serve its customers with high quality, reliable and durable products. With 50 years of knowhow in our company, we provide the market with premium electronics for vehicles. Our customers know us for our short time to market from development to start of production and reliable supply. We have all competences on board to deliver high value solutions from first sketches to the final product.

The highest precision and the use of pioneering technologies have always been as important to us as the ease of use and attractive design for all our Marine products. To ensure total reliability - even under the toughest conditions - all our products undergo extensive testing and quality assurance procedures.



Sailing Boats

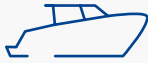

Power Boats



Inflatables



Jet-Ski



MORE ABOUT
VERATRON



WE ARE
CERTIFIED





OUR MISSION, VALUES AND VISION

Veratron serves its customers with the best equipment created and developed to be reliable even in harsh conditions.

Our values, be it within our company, for our instruments or with our customers, rely on simple words. Loyalty, trust, long-term relations, appreciation, and performance are for Veratron what boats are to ocean. Those values are essential for good and healthy collaborations.



Loyalty



Trust

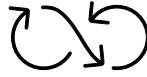

Long-Term Relation



Appreciation



Performance



Our mission implies to be sustainable and in line with our society. Complexity and global interdependencies are transforming our society faster than we ever believed. Since 2005 our company is certified according to the ISO's environmental standards: ISO14001.

Our company is compliant with the current ecological standards. Our products and production processes fulfil the highest environmental standards such as RoHS, REACH, prop 65 and others. Sustainability in everything we do, especially as an industrial company, is of paramount importance with regard to the world we leave to our children.

Veratron management and employees have been committed for years in the fields of ecology, economy and social issues and thus make their contribution. We will continue to do so in the future.

[www](#)
SUSTAINABILITY
STATEMENT



The key to understanding the future is one word: sustainability.

PATRICK DIXON, AUTHOR AND FUTURIST

OUR KNOW HOW, TO SERVE YOU BEST.



ENGINEERING SERVICES

Veratron offers 360° Engineering Services. From software development to hardware engineering, design engineering, product styling and production engineering – we provide world-class engineering competence in product development. We have 50 years of experience in finding perfect solutions for your new product or process.



ENVIRONMENTAL LABORATORY

The Veratron environmental laboratory has been certified and SAS accredited under ISO/IEC 17025 under STS 0685. We provide independent, competent and cross functional testing, in our laboratory the impact of various environmental conditions on products and components is examined.

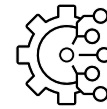

PRODUCTION SERVICES

Our automotive based production offers production services for various electronic products. We offer product styling and CAD design, simulation on Creo and SolidWorks. As experts, we manage the entire chain from 3D animation, mockup building up to the final product including the manufacturing process development.

www

READ MORE
ABOUT OUR
SERVICES



**Engineering, testing and production of
high quality electronic products is our DNA.**

VERATRON



1999

First development and
production of color display
for marine application



www

OUR HISTORY

OUR EXPERIENCE, YOUR BENEFIT

Strong history, amazing future

The name has changed several times, but many of the people developing our first-class instruments have been with us since the beginning. 50 years of experience and knowhow have been accumulated within Veratron, allowing us to provide the market with cutting edge technology and premium instruments for vehicles of all kinds.



1972

Foundation of VDO Technik AG at the new production plant in Rüthi, Switzerland.



1989

Expansion of facility and integration of marine business



1992

Start of PCB assembly in Rüthi / Switzerland.



2018

Foundation of the new company Veratron, rebranding



2021

Japanese outboard engines manufacturer added to the customer list



2023

Sustainability Project: Installation and start-up of PV system

The best way to predict the future is to create it.

ABRAHAM LINCOLN

NEW GENERATION, NEW HORIZONS – THE VMH SERIES

High-technology devices for glass cockpit dashboards.

The VMH displays line is the premium class of dashboard instruments designed to perfectly fit into the most modern cockpit concepts.

The elegant look of their optically bonded black glass display makes them the perfect match with your stylish dash. The powerful, sun-readable TFT displays offer the maximum viewing angle. Powered by the latest technology microprocessors, the VMH displays have no fear of managing the most demanding applications.

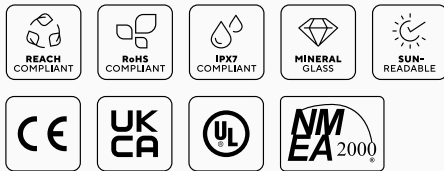

One multifunction digital display monitors your engine, tanks, batteries and more!



VMH 35
MOVIE



**VMH – The perfect device
for outboard engines' monitoring**



All your vessel data on a stylish VMH display.



30TH DAME NOMINATED 2021

VMH FLEX

Tiny device / endless possibilities

KEY FEATURES

- ▶ Up to 5 scrollable screens in single or dual layout
- ▶ Innovative laser touch-button reliable in every practical condition
- ▶ CAN bus connectivity (NMEA 2000® or J1939)
- ▶ 2x analog inputs for direct sensor connections
- ▶ Embedded analog to NMEA 2000® converter
- ▶ LIN port for Intelligent Battery Sensor



Small but powerful, the **VMH FLEX** is the perfect compromise to display a large amount of boat data in a compact device. No matter if you are wearing gloves or if it is raining on your deck, the innovative laser touch-button allows you to scroll up to 5 different screens. Every screen can be freely customized with your most important information, and the setup – including alarms – is easily done with your smartphone just with a »tap«.

Capable of reading from both sensors and CAN the **VMH FLEX** is further empowered by the LIN connectivity to get all the information from your battery thanks to the Intelligent Battery Sensor.

ARTICLE NR.

NMEA 2000®	B00186401
SAE J1939	B00127801



www

DISCOVER MORE

VMH 35

Stylish black glass cockpit design / slim panel profile / powerful core

KEY FEATURES

- ▶ Stylish black-glass design with brushed stainless-steel ring
- ▶ New generation sun-readable color hybrid display
- ▶ Intelligent Battery Sensor (IBS) port
- ▶ Analog to NMEA 2000® gateway
- ▶ Integrated high-performance GNSS receiver
- ▶ NMEA 2000® certified
- ▶ Customizable startup screen



Designed with stylish mineral glass front lens framed by a brushed stainless-steel ring, it can display a wealth of critical boat system data in a compact package that's perfect for cockpits on smaller vessels with limited space.

The **VMH 35** has an embedded GNSS receiver to support and show navigation information, while it is able to monitor analog input directly, such as fuel, trim, and tachometer. A special input is dedicated to the Veratron IBS (Intelligent Battery Sensor). It can provide critical 12V battery monitoring information. All these data are distributed to NMEA 2000® thanks to its embedded certified gateway.

ARTICLE NR.

Resistive / GPS	B00085501
0-5 Volt / GPS	B00143501
0-5 Volt	B00143601



VMH 70

**Best-in-class touchscreen display /
full control / customizable**

KEY FEATURES

- ▼ 7" sun-readable IPS TFT touchscreen display
- ▼ Slim panel installation profile
- ▼ Mineral glass front lens
- ▼ Reliably operating in high-temperature environments
- ▼ IPX7 protection rating (exposed device)
- ▼ NMEA 2000® certified
- ▼ Embedded analog to NMEA 2000® gateway
- ▼ Customizable GUI and startup screen
- ▼ Dual SAE J1939 CAN ports
- ▼ 6x Resistive inputs
- ▼ 2x Frequency inputs
- ▼ 2x 4–20 mA inputs
- ▼ 3x Digital inputs or 0–5 V
- ▼ 2x Alarm outputs
- ▼ 2x Video inputs
- ▼ 2x EasyLink data outputs



The best-in-class **VMH 70** display is designed to manage large amounts of complex data, and thanks to its real-time operating system it ensures full control on vital engine information immediately after power up.

Easily configured to display information from up to four engines when connected to NMEA 2000® or two engines via J1939 or analog inputs simultaneously, it has large possible setting. This allows users to group similar items such as single or dual engines, battery performance, fuel, water, waste, tank level, rudder and trim, onboard systems, navigation and weather, if desired.

The device has an integrated light sensor that adjusts for easy reading without eye strain, no matter how bright or dark the conditions, and two camera inputs allow to control the engine compartment during navigation and keep an eye on the main deck while maneuvering.

The embedded NMEA 2000® gateway brings all the sensor readings and alarms to your external multifunctional display, saving the cost of an additional converter.

ARTICLE NR.

VMH 70

B00129201



Intelligent Battery Sensor (IBS) screen to keep your energy supplies under control



Lateral touch buttons are RGB illuminated and allow for a quick brightness adjustment



**Wealth of boat data
in stylish devices.**



Meet the VMH 35-D: The highly regarded VMH 35 now comes in a diesel version!



30TH
DAME
NOMINATED
2021

VMH 14

New generation 52 mm EasyLink satellites

KEY FEATURES

- ▶ VMH look-and-feel
- ▶ Digital display with visual bargraph
- ▶ EasyLink interface
- ▶ Configurable with smartphone via Airwave ready
- ▶ Trim, Voltmeter, Fuel Level, Water Temperature, Transmission Oil Temperature and Pressure, Engine Oil Temperature and Pressure



Every **VMH MASTER** can control up to 16 **VMH 14** satellites, and the installation cannot be easier with the Veratron well-known daisy chain concept.

When combined with a **VMH MASTER** device – like the brand-new **VMH 35-D** – the instrument will display the data in a bright and digital form thanks to its sun-readable color display with outstanding outdoor performances. The colored bar graph and the alarm display allow you to visually understand your data.

ARTICLE NR.

VMH 14

B00109901



www

**DISCOVER
MORE**

VMH 35-D

Diesel engine monitoring made easy

KEY FEATURES

- ▶ 12/24 V operating voltage
- ▶ SAE J1939 CAN port
- ▶ High-performance GPS embedded
- ▶ More than 30 data displayed
- ▶ 4x analog input for external sensors
- ▶ EasyLink output for up to 16 VMH 14 satellites
- ▶ Analog/CAN to NMEA 2000® gateway



The **VMH 35-D** is the perfect standalone solution for monitoring your diesel engine. With a configurable dial scale of 3000 or 4000 RPM, the **VMH 35-D** is a compact display capable of showing a wide amount of data from your engine, battery, tank, and GPS.

Specific information about your diesel engine is provided together with alarms, either received from the SAE J1939 bus or locally set through the embedded menu. Both 12V and 24V systems are supported, as well as EasyLink connectivity which allows your dashboard to be expanded with additional **VMH 14** satellite displays to always keep your sensitive data under control. The embedded high-performance GPS receiver further enhances the display capabilities by adding speed, position and heading data.

ARTICLE NR.

VMH 35-D GPS

B00171101

VMH 35-D no GPS

B00171201



»
The perfect match
for your stylish dashboard.

All round instruments of the VMH Series come in a stylish black-glass design with brushed stainless-steel ring and slim panel profile.

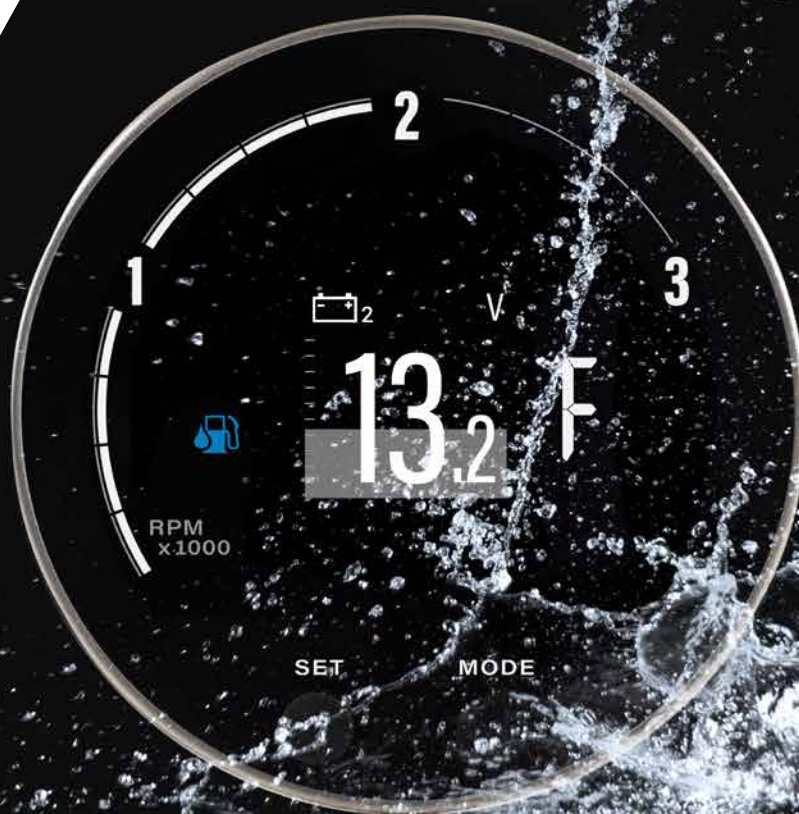

OCEANLINK™ – RELIABLE IN EVERY CONDITION

OceanLink™ – precision CAN Instrumentation for Leisure Boats.

It provides a modular instrumentation concept for electronic navigation and engine monitoring with NMEA 2000®, J1939 and analog connectivity. The product line offers a wide range of functions as well as great flexibility in installation and design.

The OceanLink™ series provides three different master instruments as centerpieces of the system: a 4.3" TFT Display, a 7" TFT touch Display and as master instruments 85 mm round gauges. All devices are information powerhouses, multifunctional tachometers and have embedded Gateway from Analog or J1939 to NMEA 2000®.

The OceanLink™ 85 mm Master gauge and the TFT Displays show various available data (e.g. engine data, depth, course over ground and speed over ground), and send it to all NMEA 2000® devices and to up to 16 additional satellite instruments. All instruments come in a new and stylish design, with perfect to read modern dials.

BENEFITS OF USING OCEANLINK™

- ▼ Easy and effective use
- ▼ Perfectly readable engine monitoring thanks to increased performance presentation
- ▼ The EasyLink data connection and the plug & play solution provide a flexible installation of panel, front and flush mounted instruments
- ▼ Decades of experience guarantee a fully reliable, modern navigation and engine monitoring system with NMEA 2000®
- ▼ A solid housing design completely sealed against dust and highly water resistant (IPX7 front and rear)
- ▼ High quality precision instruments designed in Switzerland

FURTHER ADVANCED FEATURES

- ▼ Master instruments with NMEA 2000® gateway functionality forwarding data, e.g. engine data, to NMEA compatible devices
- ▼ GPS Speedometer, 85 mm, features NMEA 2000® port, which bridges the position, COG, SOG data to the NMEA 2000® network
- ▼ Sunlight readable touch screen IPS TFT Display





www

DISCOVER
MORE



OCEANLINK™ TFT DISPLAYS

Capable of displaying data of your engines, batteries, tanks and navigation, the **OCEANLINK™** displays can tame data from either sensors, NMEA 2000® and J1939 CAN. The optically-bonded IPS TFTs ensure perfect readability under direct sunlight, to display all the critical information you need to keep under control during your journey.

The real-time operating system delivers a lightning-fast startup upon power up, able to notify alarms and system information before it's too late. Reliability is the key, the **OCEANLINK™** displays are designed to withstand high temperature environments and the harshest outdoor weather condition to never let you down, no matter what.



OceanLink™ 7" TFT Display



OL 43 TFT Display

OCEANLINK™ 7" TFT

- ▼ Touch screen function
- ▼ Optical bonded mineral glass lens
- ▼ Front and rear side protection rating IPX7
- ▼ 1x NMEA 2000® connector
- ▼ 2x J1939
- ▼ 6x Analog inputs
- ▼ 2x Frequency inputs
- ▼ 2x 4–20 mA inputs
- ▼ 3x Digital inputs or 0–5 V
- ▼ 2x Alarm outputs
- ▼ 2x Video inputs
- ▼ 2x EasyLink data outputs
- ▼ 2x Programmable alarm outputs 500 mA
- ▼ Operating temperature range -30°C/+80°C

OL 43 TFT

- ▼ Optically bonded 4.3" IPS TFT display with mineral front lens glass
- ▼ Fresh redesigned customizable user interface
- ▼ IPX7 protection class / Exposed device
- ▼ 2x analog inputs for direct sensor connection with embedded NMEA 2000® converter
- ▼ NMEA 2000® and SAE J1939 CAN ports
- ▼ Ethernet port HTML5 ready
- ▼ Optional USB-C port
- ▼ Reliable in high-temperature environments
- ▼ Lightning-fast startup upon power on
- ▼ Installation with 85 mm spinlock

VOLT.	COLOR	RESOL.	ARTICLE NR
43 12–24 V	Black	480 x 272 (WQVGA)	B00126101
7" 12–24 V	Black	800 x 480 (WVGA)	A2C1865330001



**Analog to NMEA
gateway included.**



AFTERMARKET PACKAGE

TFT Display, Bezel, Silicone Cover, Mounting Screws, Wiring Harness, Safety Instructions.

OCEANLINK™ 85 MM – MASTER GAUGES

OCEANLINK™ gauges have a white and black dial version, which is always completed with a bezel in identical color. Optionally, a chrome bezel is available as a decorative accessory.

AFTERMARKET PACKAGE

Gauge, Bezel, Rubber Seal, Spinlock, Connection Cable, Safety Instructions.

SPECIFICATIONS

- ▶ 1x NMEA 2000® input
- ▶ 1x J1939
- ▶ 1x Frequency input
- ▶ 2x Analog inputs
- ▶ 1x Alarm output 500 mA
- ▶ Reverse polarity protection
- ▶ Anti-fog double layer plastic lens
- ▶ Protection rating IPX7
- ▶ Operating temperature range -20°C/+70°C



85 mm GPS Speedometer
0-35 knots/kmh/mph



85 mm GPS Speedometer
0-14 knots/kmh/mph



85 mm Tachometer 3000 rpm



85 mm Tachometer 5000 rpm

GPS SPEEDOMETER



The **OCEANLINK™** GPS Speedometer features an embedded GPS antenna, an inverted dot matrix LCD and NMEA 2000® connectivity. Up to sixteen 52 mm satellite gauges can be connected thanks to the integrated EasyLink connectivity.

DISPLAYED DATA

Heading, Depth, Seawater Temperature, Boat Speed, SOG, Date & Time, Battery Status, Air Temperature, Engine Oil Pressure, Fuel Level, RPM, Coolant Temperature, Transmission Gear Temperature, Fresh Water Level, Waste Water Level, Trim, Engine Hours, Rudder Status, Boost Pressure, COG and alarms.

TACHOMETER



The **OCEANLINK™** Tachometer automatically presents all the key boat data on a digital dot matrix display. Beside the two digital interfaces, supporting the NMEA 2000® and SAE J1939 data protocols, there is also one analog frequency input as well as two resistive ones. The innovative EasyLink data connection makes the installation of further 52mm Satellite Gauges easy and cost effective.

OCEANLINK™ is available in various designs and a number of bezel color options. The instruments can also be conveniently integrated into customer-specific panel solutions. The Tachometer displays all important engine related data and distributes it to up to sixteen 52 mm satellite gauges.

RANGE	VOLTAGE	COLOR	ARTICLE NR
0-14 knots / kmh/mph	12-24 V	Black White	A2C1351970001 A2C1352010001
0-35 knots / kmh/mph	12-24 V	Black White	A2C1351980001 A2C1352080001
0-70 knots / kmh/mph	12-24 V	Black White	A2C1351990001 A2C1352090001

RANGE	VOLTAGE	COLOR	ARTICLE NR
3000 rpm	12-24 V	Black White	A2C1065660001 A2C1065670001
5000 rpm	12-24 V	Black White	A2C1065720001 A2C1065800001
7000 rpm	12-24 V	Black White	A2C1065810001 A2C1065820001

OCEANLINK™ 52 MM - GAUGES

OCEANLINK™ 52 mm Gauges are connected directly to any **OCEANLINK™** Master unit using the patented EasyLink serial bus connection. Up to 16 EasyLink gauges for each Tachometer or GPS Speedometer can be daisy-chained together. **OCEANLINK™** Gauges have a white and black dial version, which is always completed with a bezel in identical color. Optionally a Chrome Bezel can be selected from the accessories list on page 60.

SPECIFICATIONS

- ▶ AMP Superseal EasyLink connector
- ▶ Current consumption < 100 mA
- ▶ 270° pointer deflection angle
- ▶ Reverse polarity protection
- ▶ Anti-fog double layer plastic lens
- ▶ Front & rear protection rating IPX7
- ▶ Operating temperature range -20°C/+70°C



AFTERMARKET PACKAGE

Gauge, Bezel, Rubber Seal, Spinlock, Installation Instructions, Safety Instructions



Plug-and-Play
serial connection up
to 16 satellites.



52 mm Coolant Temperature
120°C/250°F



52 mm Engine Oil Temperature
150°C/300°F



52 mm Pyrometer
900°C/1650°F

TEMPERATURE

OCEANLINK™ 52 mm Temperature Gauges are connected directly to any **OCEANLINK™** Master unit using the patented EasyLink serial bus connection. Gauges have anti-fog plastic double lens and choice of three various bezels.

RANGE outer/inner	VOLTAGE	COLOR	ARTICLE NR
Coolant Temperature 120°C/250°F	12-24 V	Black White	A2C1065950001 A2C1065970001
Engine Oil Temperature 150°C/300°F	12-24 V	Black White	A2C1065850001 A2C1065860001
Pyrometer 900°C/1650°F	12-24 V	Black White	A2C1349690001 A2C1349710001



52 mm Boost Pressure,
2 bar/30 psi



52 mm Engine Oil Pressure,
Low/High



52 mm Transmission Oil Pressure,
30 bar/440 psi

PRESSURE

OCEANLINK™ 52 mm Pressure Gauges are connected directly to any **OCEANLINK™** Master unit using the patented EasyLink serial bus connection. Gauges have anti-fog plastic double lens and choice of three various bezels.

RANGE	VOLTAGE	COLOR	ARTICLE NR
Boost Pressure 2 bar/30 psi	12-24 V	Black White	A2C1066140001 A2C1066150001
Engine Oil Temperature 10 bar/150 psi	12-24 V	Black White	A2C1066000001 A2C1066010001
Transmission Oil Pressure 30 bar/440 psi	12-24 V	Black White	A2C1066040001 A2C1066050001



52 mm Fuel Level
Empty-Full



52 mm Fresh Water Level
Empty-Full



52 mm Waste Water Level
Empty-Full

LIQUID LEVEL

OCEANLINK™ 52 mm Liquid Level Gauges are connected directly to any **OCEANLINK™** Master unit using the patented EasyLink serial bus connection. Gauges have anti-fog plastic double lens and choice of three various bezels.

RANGE	VOLTAGE	COLOR	ARTICLE NR
Fuel Level Empty-Full	12-24 V	Black White	A2C1065930001 A2C1065940001
Fresh Water Empty-Full	12-24 V	Black White	A2C1065910001 A2C1065920001
Waste Water Empty-Full	12-24 V	Black White	A2C1065890001 A2C1065900001



www

OCEANLINK™
INSTRUMENTS



52 mm Voltmeter 16-32 V



52 mm Current -150/+150 A



52 mm Engine Trim

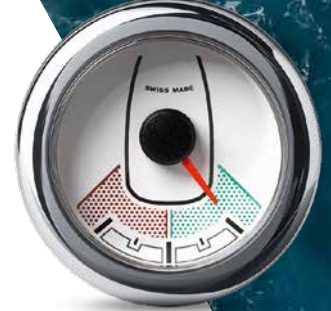

52 mm Rudder Angle

BATTERY STATUS

OCEANLINK™ 52 mm Battery Status Gauges are connected directly to any **OCEANLINK™** Master unit using the patented EasyLink serial bus connection. Gauges have anti-fog plastic double lens and choice of three various bezels.

RANGE	VOLTAGE	COLOR	ARTICLE NR
Current -60/+60 A	12-24 V	Black	A2C1349640001
		White	A2C1349660001
-150/+150 A	12-24 V	Black	A2C1349650001
		White	A2C1349680001
Voltage 8-16 V	12-24 V	Black	A2C1066100001
		White	A2C1066110001
16-32 V	12-24 V	Black	A2C1066120001
		White	A2C1066130001

VESSEL STATUS

OCEANLINK™ 52 mm Vessel Status Gauges are connected directly to any **OCEANLINK™** Master unit using the patented EasyLink serial bus connection. Gauges have anti-fog plastic double lens and choice of three various bezels.

RANGE	VOLTAGE	COLOR	ARTICLE NR
Rudder Angle 90°	12-24 V	Black	A2C1066080001
		White	A2C1066090001
Engine Trim Up / Down	12-24 V	Black	A2C1065830001
		White	A2C1065840001

**Land was created to
provide a place for boats to visit.**

BROOKS ATKINSON



VIEWLINE – EASY TO INSTALL, EASY TO CUSTOMIZE, EASY TO USE

ViewLine offers a comprehensive modular, modern series of instruments for engine monitoring.

More functions and greater flexibility in installation and design increase the scope for high manufacturing standards and guarantee the highest level of reliability and readability. As the result of ongoing research and development work, we offer an innovative, comprehensive standard instrumentation platform which is also available for outboard engine use. ViewLine provides maximum freedom to customize the cockpit and is the natural choice for an attractive price/performance ratio.

BENEFITS OF USING VIEWLINE

- ▼ Anti-fog plastic double lens, maximum precision and stylish design with choice of nine various bezels.
- ▼ Our plug and play solution design concept offers a high level of installation flexibility for panel, front and flush mounted instruments.
- ▼ ViewLine offers maximum freedom in respect of cockpit customization.
- ▼ We ensure seamless integration and optimum utilization of ViewLine devices for extreme sea conditions.

Live your life by a compass, not a clock.

/
STEPHEN R. COVEY

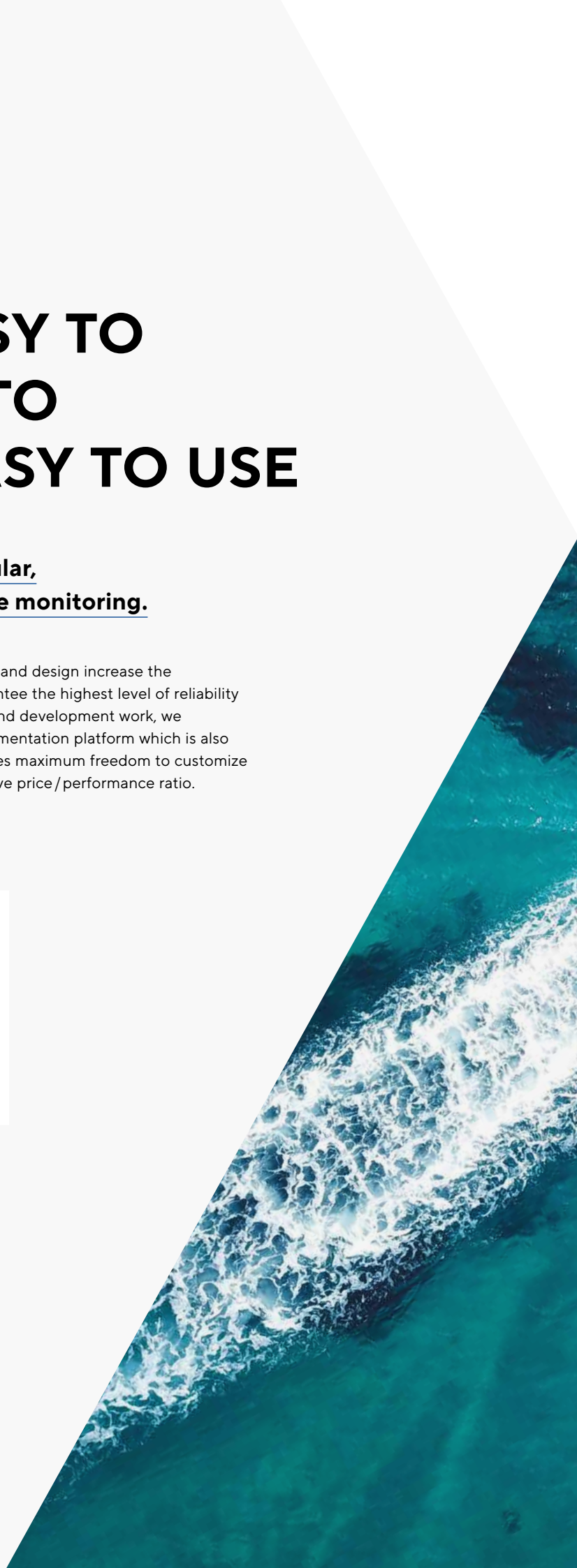



www

DISCOVER
MORE



VL FLEX SERIES

All-in-one / universal / contactless device configuration / all-rounder

The **VL FLEX** device can easily be configured to be the instrument you need – thanks to its sun-readable 1.44" TFT display embedded into a standard 52 mm instrument housing. The supported analog inputs allow you to directly read from your engine sensors, and the NMEA 2000® or J1939 interface expands this possibility by allowing the device to read from the digital network. The simple but effective graphic design can be set up in a single or dual layout, presenting the data in a clear and intuitive form, while the colored bar graph and the alarm display allow you to visually understand your data.

GENERAL FEATURES

- ▼ 52 mm instrument with 1.44" TFT display
- ▼ 2 instruments in 1 with dual screen
- ▼ Wireless configurable with your smartphone
- ▼ Powerless configuration
- ▼ Custom alarms setup
- ▼ Color bar graphs for visual data display
- ▼ 9 different styling rings available



WIRELESS CONFIGURATION IN JUST 3 STEPS:

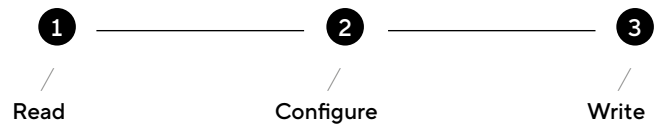

CONFIGURATOR SMARTPHONE APP

- ▼ To configure the **VL FLEX**, some parameters must be calibrated, like the gauge type, the sensor and its calibration or the warning threshold. This is possible through the **»VL FLEX CONFIGURATOR«** smartphone App.
- ▼ A simple and detailed explanation of the configuration process is also available as in-app instructions.
- ▼ Thanks to the passive embedded NFC receiver, the VL Flex 52 can be configured without power supply.

TECHNICAL DATA

Display	1.44" sun-readable color TFT display
Resolution	125 x 125 pixels
Nominal Voltage	12 V / 24 V
Operating Voltage	8 – 32 V with overvoltage and reverse polarity protection
Current consumption	Typ. 50 mA with max. backlight intensity
Analog ports	Resistive (0 – 400 Ω), Frequency (W, Ind, Hall, Generator)
Digital ports	NMEA 2000® or J1939, LIN bus
Wireless interface	Airwave (NFC-Based)
Protection class	IP 67 front side acc. IEC60529
Lens	PMMA with anti-glare and anti-fog
Housing	Ø 52 mm – Polycarbonate (PC), flame retardant acc. UL94-V0
Operating temperature	-20°C to +70°C
Storage temperature	-30°C to +80°C
Connector	Tyco / Hirschmann MQS connector 8 pin



**» DOWNLOAD
CONFIGURATOR APPS**





NMEA 2000®

The supported analog inputs allow you to directly read from your engine sensors. In addition NMEA 2000® and LIN 2.0 interface expands this possibility by allowing the device to read from the digital network.

FEATURES

- ▼ **NMEA 2000® gateway included**
- ▼ Configurable Resistive and frequency inputs
- ▼ IBS port for battery monitoring
- ▼ Custom alarm setup
- ▼ 23 data available in different units
- ▼ Wireless configurable via smartphone App

ARTICLE NR.

NMEA 2000® White	B00111301
NMEA 2000® Black	B00043501



J1939

The supported analog inputs allow you to directly read from the sensors. In addition, the J1939 and the LIN 2.0 interfaces make it possible for the VL Flex to read from the digital networks as well.

FEATURES

- ▼ SAE J1939 compatible
- ▼ Configurable Resistive and frequency inputs
- ▼ IBS port for battery monitoring
- ▼ Custom alarm setup
- ▼ 29 data available in different units
- ▼ Wireless configurable via smartphone App

ARTICLE NR.

J1939 White	B00110901
J1939 Black	B00086001



IBM

The Intelligent Battery Monitoring System informs you about the current energy status, allowing you to plan your energy supply making it the key element of the vehicle's energy management.

FEATURES

- ▼ Flex display kit for Battery monitoring
- ▼ 1x Resistive input for Fuel or Fresh Water level
- ▼ Dedicated harness with pushbutton for screen scrolling
- ▼ Battery charge notification

ARTICLE NR.

IBM 12 V	B00084701
IBM 24 V	B00084801



VL Flex combines two instruments in one, is cost-saving and practical.



VIEWLINE 110 MM GAUGES

VIEWLINE accessories bezel concept offers true design flexibility in the layout of instrument panels. The three attractive designs in black, white and chrome are suitable for every machinery instrument panel or special vehicle cockpit.

Based on the **VIEWLINE** housing concept, the cluster provides an ideal IP protection class, a modern appearance and high quality standards. It provides many parameters in NMEA 2000® and there are several customization opportunities to meet specific customer demands.

AFTERMARKET PACKAGE

Gauge, GPS speed cable, Bezel, Pushbutton for mode and configuration, Rubber Seal, Spinlock, Drilling Template, Installation Instructions, Safety Instructions.



110 mm GPS Speedometer
0-12 knots/kmh/mph



110 mm GPS Speedometer
0-70 knots/kmh/mph

GPS SPEEDOMETER

The GPS Speedometer features an embedded GPS antenna, a fixed segment LCD, and able to read NMEA 2000®. The external push button allows to display different data on the LCD.

RANGE	VOLTAGE	COLOR	ARTICLE NR
0-12 knots / kmh/mph	8.5-16 V	Black	A2C59501987
0-35 knots / kmh/mph	8.5-16 V	Black	A2C59501782
0-70 knots / kmh/mph	8.5-16 V	Black	A2C59501781

SPECIFICATIONS

- ▼ Embedded GPS antenna
- ▼ Robust and flexible design for versatile applications
- ▼ CAN capability (NMEA 2000®)
- ▼ Pointer for analog indication of Speed over Ground (SOG)
- ▼ Programmable speed alarm
- ▼ Fixed segment LCD
- ▼ Flush mount possibility
- ▼ Front side protection rating IP67
- ▼ Compass for Course over Ground (COG)
- ▼ Clock
- ▼ 110 mm installation diameter
- ▼ 126 mm outer diameter
- ▼ 50 mm installation depth
- ▼ Reverse polarity protection
- ▼ 1x Telltale generic alarm
- ▼ 1x Telltale alarm (knots/kmh/mph)

DISPLAYED DATA

GPS signal quality, Course over ground (COG), UTC time (optional with external push button), Trip distance (optional with external push button), Trip time (optional with external push button)

VIEWLINE 85 MM GAUGES

The **VIEWLINE** 85 mm Gauges are available in black or white dial versions, which are always completed with a round bezel in identical color. **VIEWLINE** accessories bezel concept offers true design flexibility in the layout of instrument panels. The three attractive designs in black, white and chrome are suitable for every machinery instrument panel or special vehicle cockpit.

AFTERMARKET PACKAGE

Gauge, Bezel, Rubber Seal, Spinlock, Connection Cable, Installation Instructions, Safety Instructions.

SPECIFICATIONS

- ▼ 8 and 14 pole Tyco/Hirschmann bush housing
- ▼ Operating voltage 8–32 V
- ▼ Accuracy +/- 2.5 % of full scale reading
- ▼ <175 mA current consumption with an LED warning light as standard
- ▼ Number of pulses programmable via Configuration Key and LCD
- ▼ Anti-fog double lens
- ▼ Protection rating front IP67, rear IP52
- ▼ 85 mm installation diameter
- ▼ 50 mm installation depth
- ▼ Operating temperature range -20°C/+70°C



Black, white or chrome.

Choose the design fitting in your cockpit.



Speedometer / 0–60 kmh



SPEEDOMETER

The **VIEWLINE** 85 mm Speedometer with LCD and push button included offers plug and play solution concept and installation flexibility for panel, front and flush mounted instruments.

RANGE	VOLTAGE	COLOR	BEZEL	ARTICLE NR
0–60 kmh	12–24 V	Black	Triangular black	A2C59512367
0–120 kmh	12–24 V	Black	Triangular black	A2C59512369
0–200 kmh	12–24 V	Black	Triangular black	A2C59512370
0–300 kmh	12–24 V	Black	Triangular black	A2C59512371



85 mm Engine Revolution, Engine Hours, Voltage and Clock, 5000 rpm



85 mm Engine Revolution, Engine Hours, Voltage and Clock, 3000 rpm



85 mm Engine Revolution of two engines -500/+500 rpm



85 mm Rudder Angle
-45°/+45°

ENGINE REVOLUTION, ENGINE HOURS, VOLTAGE AND CLOCK

The **VIEWLINE** Tachometer with operating hours counter (digital display) can be connected to conventional marine engines (no data bus). One LED warning light is integrated as a standard.

SPECIFICATIONS

- ▼ Current consumption < 175 mA, with warning light (LED)
- ▼ Various sensor inputs
- ▼ LCD size 37 mm x 11 mm
- ▼ Individually programmable display e.g., for clock, trip, odometer, etc. via externally switchable button or PC software (ViewLine programming tool)
- ▼ Reverse polarity protection

RANGE	VOLTAGE	COLOR	INPUT	ARTICLE NR
3000 rpm	8-32 V	Black White	W, Ind, Hall, Generator	A2C59512390 A2C59512396
4000 rpm	8-32 V	Black White	W, Ind, Hall, Generator	A2C59512391 A2C59512397
5000 rpm	8-32 V	Black White	W, Ind, Hall, Generator	A2C59512392 A2C59512398
6000 rpm	8-32 V	Black White	W, Ind, Hall, Generator	A2C59512393 A2C59512399
7000 rpm	8-32 V	Black White	W, Ind, Hall, Generator	A2C59512394 A2C59512400
8000 rpm	8-32 V	Black White	W, Ind, Hall, Generator	A2C59512395 A2C59512401

* With Pushbutton for mode and configuration

SYNCHRONIZER

On pleasure boats with twin engine installations, the **VIEWLINE** synchronizer is an indispensable aid to ensure correct synchronized running of both units.

RANGE	VOLTAGE	COLOR	INPUT	ARTICLE NR
-500/+500 rpm	8-32 V	Black White	W, 1, Ind	A2C59512402 A2C59512403

VESSEL STATUS

The **VIEWLINE** rudder angle instrument for wheel-controlled yachts and pleasure boats displays the current rudder position at all times. This indicator makes it easier to navigate out of harbors or through locks. The gauge is available in 52 and 85 mm installation diameters. Only rudder instruments of the same diameter can be combined.

RANGE	VOLTAGE	COLOR	INPUT	ARTICLE NR
-45°/+45°	8-32 V	Black White	3-180 Ω	A2C59512410 A2C59512411

VIEWLINE 52 MM GAUGES

The **VIEWLINE** 52 mm Gauges are available in black or white dial versions, which are always completed with a round bezel in identical color. **VIEWLINE** accessories bezel concept offers true design flexibility in the layout of instrument panels. The three attractive designs in black, white and chrome are suitable for every machinery instrument panel or special vehicle cockpit.

AFTERMARKET PACKAGE

Gauge, Bezel, Rubber Seal, Spinlock, Connection Cable, Installation Instructions, Safety Instructions, Card for online manuals

SPECIFICATIONS

- ▼ 8 pole Tyco/Hirschmann MQS plug
- ▼ +/- 3.6° angle degree accuracy over the entire display range
- ▼ Operating voltage 8–32 V
- ▼ Integrated warning alarm
- ▼ Supports all our standard sensors
- ▼ Optional make-point switch can be connected
- ▼ Reverse polarity protection
- ▼ Anti-fog double lens
- ▼ Front side protection rating IP67
- ▼ 52 mm installation diameter
- ▼ 50 mm installation depth



52 mm Coolant Temperature
250°F/120°C



52 mm Engine Oil Temperature
150°C/300°F



52 mm Pyrometer
1650°F/900°C



52 mm Outside Temperature
+120°F/+50°C

TEMPERATURE

VIEWLINE Temperature gauges with Anti-fog plastic double lens promise maximum precision and stylish design with choice of nine various bezels. One LED warning light is integrated as a standard.

RANGE	VOLTAGE	COLOR	INPUT	ARTICLE NR
outer/inner				
Coolant Temperature				
120°C/250°F	8–32 V	Black White	287.4–22.7 Ω	A2C59514170 A2C59514237
250°F/120°C	8–32 V	Black White	287.4–22.7 Ω	A2C59514176 A2C59514241
Engine Oil Temperature				
150°C/300°F	8–32 V	Black White	322.8–18.6 Ω	A2C59514160 A2C59514231
Cold/Hot (300°F)	8–32 V	Black White	322.8–18.6 Ω	A2C59514165 A2C59514234
Pyrometer				
900°C/1650°F	8–32 V	Black White	37 mV	A2C59512332 A2C59512333
1650°F/900°C	8–32 V	Black White	37 mV	A2C59512334 A2C59512335
Outside Temperature				
+50°C/+120°F	8–32 V	Black White	2k Ω	A2C59512336 A2C59512338
+120°F/+50°C	8–32 V	Black White	2k Ω	A2C59512337 A2C59512339



52 mm Boost Pressure
2 bar/30 psi



52 mm Engine Oil Pressure
30 bar/435 psi



52 mm Transmission Oil Pressure
25 bar/350 psi

PRESSURE

VIEWLINE 52 mm Pressure Gauges are equipped with a red warning LED as a standard. The warning point depends on the chosen pressure sensor with warning contact or can be controlled by installing a make-point switch. Anti-fog plastic double lens, maximum precision and stylish design with choice of nine various bezels. The 0-5 Volt Gauge compatible with Electronic Pressure Sensors displays the engine or gearbox oil pressure.

RANGE outer/inner	VOLTAGE	COLOR	INPUT	ARTICLE NR
Boost Pressure				
2 bar/30 psi	8-32 V	Black White	10-184 Ω	A2C59514149 A2C59514225
Engine Oil Pressure				
5 bar/80 psi	8-32 V	Black White	10-184 Ω	A2C59514123 A2C59514211
80 psi/5 bar	8-32 V	Black White	10-184 Ω	A2C59514128 A2C59514214
10 bar/150 psi	8-32 V	Black White	10-184 Ω	A2C59514111 A2C59514199
150 psi/10 bar	8-32 V	Black White	10-184 Ω	A2C59514117 A2C59514202
Transmission Oil Pressure				
25 bar/350 psi	8-32 V	Black White	10-184 Ω	A2C59514136 A2C59514206
30 bar/435 psi	8-32 V	Black White	10-184 Ω	A2C59514141 A2C59514208
400 psi/25 bar	8-32 V	Black White	10-184 Ω	A2C59514145 A2C59514223
10 bar	12-24 V	Black	0-5 V	A2C1278230001
30 bar	12-24 V	Black	0-5 V	A2C1278250001



52 mm Fresh Water
0-1/1

LIQUID LEVEL

VIEWLINE 52 mm Liquid Level gauges with anti-fog plastic double lens promise maximum precision and stylish design with choice of nine various bezels. One LED warning light is integrated as a standard.

RANGE outer/inner	VOLTAGE	COLOR	INPUT	ARTICLE NR
Fuel Level				
Empty-Full	8-32 V	Black White	0-90 Ω	A2C59514085 A2C59514186
0-1/1	8-32 V	Black White	3-180 Ω	A2C59514082 A2C59514184
Empty-Full	8-32 V	Black White	240-33.5 Ω	A2C59514094 A2C59514190
0-1/1	8-32 V	Black White	90-4 Ω	A2C59514079 A2C59514182
Empty-Full	8-32 V	Black White	90-4 Ω	A2C59514088 A2C59514188
Fresh Water (capacitive)				
0-1/1	8-32 V	Black White	4-20 mA	A2C59514676 A2C59514677
Fresh Water (resistive)				
0-1/1	8-32 V	Black White	3-180 Ω	A2C59514097 A2C59514192
Empty-Full	8-32 V	Black White	3-180 Ω	A2C59514099 A2C59514193
Waste Water				
0-1/1	8-32 V	Black White	4-20 mA	A2C59512342 A2C59512343



52 mm Current
-60/+60 A



52 mm Voltage
18-32 V



52 mm Rudder Angle
-40°/+40°



52 mm Engine Trim

BATTERY STATUS

VIEWLINE Ammeter shows the current flow. The voltmeter displays the output voltage of generator and battery.

RANGE	VOLT.	COLOR	INPUT	ARTICLE NR
outer/inner				
Current				
-60/+60 A	8-32 V	Black White	60 mV	A2C59512328 A2C59512330
-150/+150 A	8-32 V	Black White	60 mV	A2C59512329 A2C59512331
Voltage				
8-16 V	8-16 V	Black White	8-16 VDC	A2C59512545 A2C59512546
18-32 V	18-32 V	Black White	18-32 VDC	A2C59512458 A2C59512459

VESSEL STATUS

Available in 52 and 85 mm the **VIEWLINE** rudder angle indicator makes it easier to navigate out of harbors or through locks.

RANGE	VOLT.	COLOR	INPUT	ARTICLE NR
outer/inner				
Rudder Angle				
-40°/+40°	8-32 V	Black White	3-180 Ω	A2C59514154 A2C59514230
Engine Trim				
up/down	8-32 V	Black White	167-10 Ω	A2C59514180 A2C59514244



52 mm Hour Counter-Voltmeter



52 mm Clock



Acoustic Buzzer



Warning Gauge with optional
white round bezel

HOUR COUNTER-VOLTMETER

VOLTAGE	COLOR	ARTICLE NR
9-48 V	Black round bezel White round bezel	B00005302 B00006302
9-48 V	Black triangular bezel White triangular bezel	B00005303 B00006303

ACOUSTIC BUZZER

VOLTAGE	COLOR	ARTICLE NR
12-24 V	Black round bezel	B00109001

CLOCK

VOLTAGE	COLOR	ARTICLE NR
8-16 V	Black round bezel White round bezel	A2C59513445 A2C59513443
8-32 V	Black triangular bezel White triangular bezel	A2C59513446 A2C59513444

WARNING GAUGE

VOLTAGE	COLOR	ARTICLE NR
8-16 V	White dial, black flat bezel	B00015501



STR
Veratron
Phi Number
STR

7.0
110.000
046
109

Phi Number

STR

veratron

NAVIGATION - WHERE THE WIND TAKES YOU

MAST DISPLAY UNITS

The **VERATRON** mast brackets are an elegant and efficient solution for mast installation. They hold either one (portrait mode) or three (landscape mode) 7" TFT displays and a rear cover is available with minimum installation space thanks to the **ACQUALINK™** daisy-chain between displays. Thanks to the easy touch-based interaction to setup the pages, the TFTs can display up to 16 data, such as wind, speed, depth but also battery voltage and distances.

The Mast Display functionality is implemented in all 7" **ACQUALINK™** TFTs

- ✔ Landscape and Portrait orientation
- ✔ Automatic detection of AcquaLink™ NavBox to self configure as Mast Display

AFTERMARKET PACKAGE

Triple: Carbon Bracket (B00028501), 3x 7" **ACQUALINK™** Displays with Black Bezel and Silicone Cover, NMEA 2000® Adapter Cable, Terminator, Cables.

Single: Aluminium Bracket, 1x 7" **ACQUALINK™** Display with Black Bezel and Silicone Cover, NMEA 2000® Adapter Cable, Terminator, Cables.

TECHNICAL SPECIFICATIONS:

- ✔ as ACQUALINK™ 7" TFT Displays
- ✔ IPS technology display
- ✔ High readability
- ✔ NMEA 2000® compatible
- ✔ IP67 exposed
- ✔ Touch screen with swipe function
- ✔ Touch buttons
- ✔ Operating temperature range design for -30°C to +80°C

MAST DISPLAY UNIT	ARTICLE NR
Triple	B00033101
Single	B00044701



Mast Display Unit Triple



Mast Display Unit Single





AcquaLink™ 7" TFT Display

SPECIFICATIONS:

- ▶ 4.3": 1x plug with 2x Video Input
- ▶ 7": 2x plugs with 4x Video Input
- ▶ 2x VDO Bus connectors
- ▶ Operating temperature range -30°C/+80°C
- ▶ Protection level front and rear IPX9K with connectors plugged

TFT DISPLAYS

ACQUALINK™ multifunction TFT Displays are available in 4.3" and 7" sizes. The full 24 bit/16 m colors optically bonded IPS technology displays feature transmissive layer technology for unprecedented and unsurpassed readability even in direct sunlight. The TFT Displays show a wide array of data received from the **ACQUALINK™ NAVBOX** or NMEA 2000®. Users can customize up to 40 different data pages with single, double, triple or quadruple grid layouts.

The Displays can be daisy-chained with other **ACQUALINK™** gauges, displays or NavControls using the unique VDO Bus or directly connected to the NMEA 2000® backbone (optional adapter cable required) for simple installation on any yacht.

7" TFTs are equipped with capacitive multi touch screens to slide between pages whereas 4.3" displays require the use of a NavControl unit for data input and operation.

AFTERMARKET PACKAGE

TFT Display, Black Bezel, Silicone Cover, Mounting Screws, Drilling Template, Installation Instructions, Safety Instructions.

* Optionally white bezel can be selected from the accessories p 60.

VOLT.	RESOL.	ART. NR
4,3"		
12-24 V	480 x 272 (WQVGA)	A2C59501996
7"		
12-24 V	800 x 480 (WVGA)	A2C59501997

NAVIGATION



The **OCEANLINK™** Navigation gauges display compass, wind angle, apparent wind angle magnified, wind speed and depth information received from NMEA 2000® data bus.

RANGE	VOLTAGE	COLOR	ARTICLE NR
Compass			
360°	12-24 V	Black	A2C1957380001
Wind Angle			
360°	12-24 V	Black	A2C1957400001
Apparent Wind Angle Magnified			
360°	12-24 V	Black	A2C1957390001
Wind Speed			
0- 50 knots	12-24 V	Black	A2C1957420001
Depth			
200 m / 660 feet	12-24 V	Black	A2C1957360001



85 mm Wind Angle Magnified



Professional Rudder Angle Indicator

PROF. RUDDER ANGLE INDICATOR

The **OCEANLINK™** Professional Rudder Angle Indicator suits any commercial applications thanks to the embedded NMEA 0183 transreceiver. Its infrared push button allows for a user-friendly fine tuning of the predefined calibration.

RANGE	VOLTAGE	COLOR	ARTICLE NR
Rudder			
-45°/+45°	8-32 V	Black	B00067401

NAVCONTROL

The **NAVCONTROL** can assume control of any TFT Display connected to the VDO Bus or NMEA 2000® network. Even multiple units can be connected to the same Bus without conflicts.

SPECIFICATIONS

- ▼ Compatible with AcquaLink™ and OceanLink™
- ▼ 2x VDO Bus connectors
- ▼ Operating temperature range -30°C/+80°C
- ▼ Protection level IPX6
- ▼ Reverse polarity protection
- ▼ Telltales light indication



NavControl

AFTERMARKET PACKAGE

NavControl, Black Bezel, Silicone Cover, Mounting Screws, Drilling Template, Installation and Safety Instructions.

* Optionally white bezel can be selected from the accessories p. 60

VOLT.	COLOR	ARTICLE NR
12 - 24 V	Black	A2C59501982

NAVBOX



The **ACQUALINK™ NAVBOX** is the core of the **ACQUALINK™** system. It acts as a CPU and signal interface. The NavBox provides a wide range of digital and analog input possibilities. It supports up to four digital engines (J1939 or NMEA 2000®) or one analog engine. It also features two Sumlog™ paddle wheel sensor and one analog Wind Sensor connections, so legacy products can be used and brought to the digital age.

NAVBOX READS FOLLOWING ANALOG DATA:

- | | |
|------------------------------|---|
| ▼ Engine Oil Pressure | ▼ Engine Frequency |
| ▼ Engine Oil Temperature | ▼ Fresh Water, Waste Water and Fuel Level |
| ▼ Engine Coolant Temperature | ▼ Rudder Angle |
| ▼ Transmission Oil Pressure | ▼ Battery Current |
| ▼ Voltage | ▼ Amperemeter |

It also features a NMEA 0183 input and output port as well as a buzzer output. All the data received are converted and sent to the NMEA 2000® network and to the VDO Bus. This gateway function allows displaying engine, liquid level, pressure, temperature and other vital information on any compatible display on the NMEA 2000® network or on designed AcquaLink™ devices. The configuration of the NavBox can be done by using either an AcquaLink™ TFT and NavControl or by using the intuitive configuration tool.

AFTERMARKET PACKAGE

NavBox, Power cable & fuse, 26 pin harness, VDO-bus terminating resistors (3 pc.), Mounting Screws, Safety, Installation and Operation Manual, Drilling Templates.



NavBox

SPECIFICATIONS

- ▼ Reverse polarity protection
- ▼ NMEA 2000® certified
- ▼ LED signal status indication
- ▼ Aluminum base plate
- ▼ Front+rear side protection rating IPX4
- ▼ 3x VDO bus lines
- ▼ 1x J1939 CAN bus
- ▼ 1x NMEA 2000® bus
- ▼ 1x Analog Wind Sensor Input
- ▼ 2x Sumlog™ Inputs
- ▼ AMP Super Seal power input
- ▼ 26 pin AUX input (analog signals, NMEA 0183)
- ▼ Operating temperature range -20°C/+70°C

VOLTAGE	ARTICLE NR
12 - 24 V	A2C59501979



NAVSENSOR

The multifunctional **ACQUALINK™** NavSensor offers an inertial sensor with a GNSS receiver module to provide the accurate readings of speed of travel as well as pitch & roll. Compass readings can be displayed electronically thanks to the embedded Fluxgate compass, which also facilitate course corrections in electronic autopilots. The barometer and air temperature sensors are early indicators of forthcoming weather conditions.

SPECIFICATIONS

- ▼ NMEA 2000® certified
- ▼ IPX6 extended protection rating
- ▼ GPS Module: Position, time, boats vector, signal quality, satellites
- ▼ Compass: +/-40° tilt angle, <2° accuracy, alarm (rapid field strength change, tilt angle overrun, undervoltage condition)
- ▼ Barometer and air temperature sensor
- ▼ Operating temperature range -20°C/+70°C

AFTERMARKET PACKAGE

NavSensor, 2x brackets, Installation and Safety Instr.

VOLTAGE	ARTICLE NR
12-24 V	A2C59501981

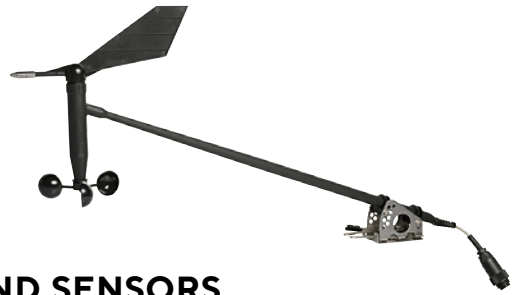

WIND SENSORS

The wind vane turns in the direction of the wind and steers the wind direction gauge. The wind cups record the relative wind speed which in turn is displayed on the wind speed gauge.

VARIANT	ARTICLE NR
Wind Short Arm Sensor NMEA 2000®	A2C59501984
Wind Short Arm Sensor Analog	A2C59501983



NMEA 2000® TRIDUCER SENSOR

Through-hull 100 W multisensor provides depth, speed, attitude and seawater temperature data. The sensor is NMEA 2000® certified and thanks to the built-in Bluetooth Low Energy interface can be easily calibrated with your smartphone.

VOLTAGE	ARTICLE NR
9-16 V	IDST 810-40-01



VERATRON GO. ONE LOOK - DIFFERENT FUNCTIONS.

VERATRON GO is NMEA 2000® certified and features an integrated GPS/GLONASS/GALILEO receiver. Compact and easy to install, it does not require any additional protection against harsh weather conditions. The **GO PLUS** variant integrates a Bluetooth 5.1 Low Energy interface allowing the visualization of boat data on your portable devices, such as smartphone or tablet. The **GO DATA** variant provides you with Bluetooth.



KEY FEATURES

- ▼ High-performance GNSS receiver
- ▼ 10 Hz update rate 72 channels
- ▼ Very high tracking sensitivity
- ▼ Bluetooth Low Energy gateway
- ▼ All your vessel data on your smart device
- ▼ Powered by NMEA 2000® network
- ▼ NMEA 2000® certified
- ▼ Global BLE certified



Smallest NMEA 2000® GNSS antenna on the market.

ART. NR. B00034901

GO GPS

VERATRON GO is the smallest NMEA 2000® certified GNSS receiver on the market which supports GPS / GLONASS / GALILEO constellations. Compact and easy to install, it does not require any additional protection against harsh weather conditions.

ART. NR. B00041601

GO DATA

VERATRON GO DATA is an NMEA 2000® to Bluetooth Low Energy (BLE) gateway. Together with the Veratron smartphone and tablet apps you can monitor your engine, read your sailing performance data, keep an eye on your batteries status and receive alarm notifications.

ART. NR. B00041701

GO PLUS

VERATRON GO PLUS+ is a combined GPS receiver and NMEA 2000® to Bluetooth Low Energy (BLE) gateway and combines all the features of the Veratron GO and the Veratron GO Data devices in a single unit.

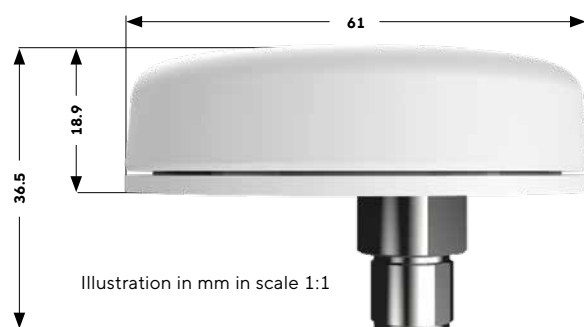

ACCESSORIES

Top-mount bracket for Veratron Go (with screws)

ARTICLE NR

B00062402



DOWNLOAD THE NAVDASH APP





DISCOVER
MORE



ELECTRONIC CONTROL UNITS AND GATEWAYS

ENGINEBOX

The **ENGINEBOX** expands the possibilities of the NavBox for multi-engine applications or can be used as stand-alone when navigation information is not required. The EngineBox has a NMEA 2000® and a J1939 CAN port. The EngineBox can also be used on older, completely analog engines, thanks to the analog input ports provided and designed for RPM data, resistive sensors and capacitive sensors.

The **ENGINEBOX** is available in 2 versions:

Single Engine and Dual Engine. The Dual Engine version is designed with doubled frequency and resistive inputs. It allows for a simplified installation wiring within minimized required installation space, therefore reducing the commissioning time.

The EngineBox has to be set up using an intuitive PC configuration tool making it easy for programming the inputs (delivered free of charge). Thanks to the ISO 8846:1990 compliance, the EngineBox is also designed to be installed in engine compartments.



EngineBox



SPECIFICATIONS

- ▼ Analog to NMEA 2000® gateway
- ▼ J1939 to NMEA 2000® gateway
- ▼ 2 Models for single engine and dual engine configurations
- ▼ Compact design
- ▼ Status LED
- ▼ Operating temperature range -40°C / +85°C
- ▼ 1x J1939 (2x J1939 Dual Engine)
- ▼ 1x M12 5 pins NMEA 2000®
- ▼ 1x Input 0-4 kHz for RPM (2 inputs with Dual Engine Model)
- ▼ 4x Input 0-400 Ω (8 inputs with Dual Engine Model)
- ▼ 2x Input 4-20 mA
- ▼ 2x Input 0-5 V (4 inputs with Dual Engine Model)

AFTERMARKET PACKAGE

EngineBox, Cable Harness, Safety Instructions

ENGINE	ARTICLE NR
Single Engine	A2C1824820001
Double Engine	A2C1767000001

THE LINKUP SERIES

Single function gateways to integrate sensor readings to NMEA 2000®

The single-sensor **LINKUP GATEWAYS** provide an easy method to convert vessel and engine information to NMEA 2000®. Available in different variants: resistive, voltage, LIN, J1939, IBS and 2-in-1 those can be easily configured through either the embedded NFC-based Airlink interface or NMEA 2000® by means of our Configuration Tool. The ISO 8846:1990 compliance completes the devices by allowing their installation into engine compartments

GENERAL FEATURES

- ▶ Save the money of an oversized NMEA 2000® converter
- ▶ Reduces the wiring, the gateway is installed where needed
- ▶ Contactless configuration with your smartphone, no expensive HW required!
- ▶ Powered by NMEA 2000® - no additional power supply
- ▶ Approved for engine compartment installation according to ISO 8846:1990



DOWNLOAD
THE MOBILE APP



WIRELESS CONFIGURATION IN JUST 4 STEPS:

- 1 Near your smartphone to the LinkUp area
- 2 Select the sensor and type in its configurations
- 3 Configure an alarm
- 4 Tap again your smartphone onto the LinkUp to program it instantly!

TECHNICAL DATA

Operating voltage	6 – 16.5 V
Protection class	IPX9/K
Nominal voltage	12 V / 24 V
Power consumption	≤ 15 mA (normal mode) ≤ 120 µA (sleep mode)
Output signal	NMEA 2000®
Operating temperature	-40° C to 115° C
Flammability	UL94 compliant
Compliance	CE, Reach, RoHS
Housing Material	PC-FR

VARIANTS

LinkUp Resistive	B00042201
LinkUp Pyrometer	B00042301
LinkUp IBS 12 V / 12 V II	B00042501 / B00042502
LinkUp IBS 24 V	B00070401
LinkUp 2-in-1	B00070501
LinkUp J1939	B00042401
LinkUp 0-5 Volt	B00059201

ARTICLE NR



DESIGN

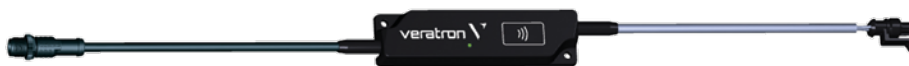

NMEA 2000®-SIDE WIRING

DeviceNet M12 connector 5 pins, 12 V power supply from the network!

LINKUP HOUSING

Contains the device electronics
Notification LED, Wireless interface

SENSOR-SIDE WIRING

Different depending on the sensor to interface



LinkUp reduces wiring, is fast, powerful and costeffective

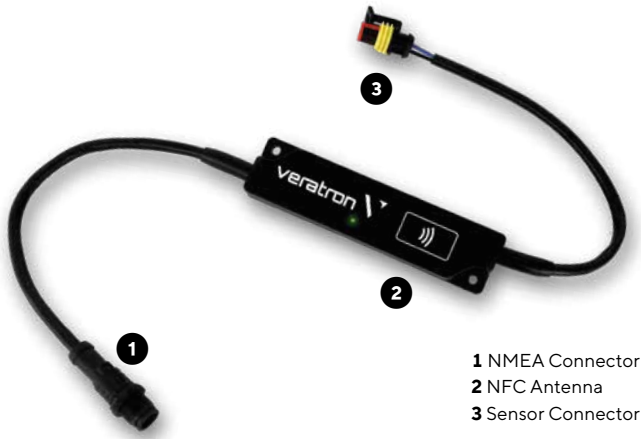

- 1 NMEA Connector
- 2 NFC Antenna
- 3 Sensor Connector

ART. NR. B00042201

RESISTIVE

The **RESISTIVE LINKUP** gateway is designed to interface and convert resistive sensors measurements – such as Level, Temperature, or Pressure sensors – to the NMEA 2000® digital era. Optimized for a 0–2000 ohm range, it can be configured with predefined sensor curves as well as with a customized characteristic to ensure compatibility with most of the sensors in the field.

FACTS AND BENEFITS

- ▼ Customizable sensor curves
- ▼ Approved for engine compartments
- ▼ Alarms setup + transmission on NMEA 2000®
- ▼ Plug-and-play installation with Veratron Dip-pipe level sensors

NMEA PGNS

Rudder	127245
Fluid Level	127505
Engine Parameters, Rapid Update	127488
Engine Parameters, Dynamic	127489
Transmission Parameters, Dynamic	127493
Trim Tab Status	130576

SUPPORTED CONFIGURATIONS

Fuel Level	Coolant Temperature
Fresh Water Level	Boost Pressure
Waste Water Level	Oil Pressure
Trim Position	Oil Temperature
Trim Tabs	Gear Oil Pressure
Rudder Angle	Gear Oil Temperature

ART. NR. B00042301

PYROMETER

Specific **LINKUP** variant designed to interface the Veratron Pyrometer thermocouple (N03-320-264)

GENERAL BENEFITS

- ▼ High precision probe for exhaust gas temperature (EGT) measurement
- ▼ Electrically compensated wires
- ▼ Extremely high temperature resistance
- ▼ Early warning of situations that are potentially dangerous for the engine!
- ▼ Helps preventing severe damages to the engine
- ▼ Can also be used as a guide for optimizing fuel economy



THE KIT INCLUDES

1 / Link-Up Pyrometer	B000423
2 / 6 m extension cable with high temperature resistance included	B000632
3 / Pyrometer thermocouple	N03-320-264

NMEA PGNS

Exhaust Temperature	130316
---------------------	--------

B00042501 (12 V) / B00042501 (12 V II) / B00070401 (24 V)

INTELLIGENT BATTERY SENSOR (IBS)

The **INTELLIGENT BATTERY MONITORING SYSTEM** informs you about the current energy status, allowing you to plan your energy supply making it the key element of the vessel's energy management. In order to carefully preserve the energy of the boat battery, it is necessary to know its State of Charge, the ageing status (State of Health) and any changes to the battery, as weak batteries are the main cause of trouble in the boat.



FACTS AND BENEFITS

- ▼ **12V and 24V** Intelligent Battery Sensors (IBS)
- ▼ Determines the current status of your battery to support energy management planning
- ▼ Helps to preserve battery life by reporting its State of Health
- ▼ Delivers **real-time measurements** preventing overcharging and overheating which can shorten battery life

	12 V B00042501	12 V II B00042502	24 V B00070401
Operating voltage	6 - 16.5 V	6 - 18 V	7.5 - 32 V
Permanent load current	± 155 A	± 200 A	± 200 A
Max current	± 1500 A	± 1500 A	± 2000 A
Threaded GND bolt (Battery pole adapter included)	M8	M6	M8
Max battery capacity	249 Ah	500 Ah	255 Ah

DESIGN AND FUNCTION

The **IBS** is attached directly to the negative pole of the battery via its pole terminal. Alongside the terminal, the mechanical portion of the battery sensor consists of the shunt and grounding bolt.

DELIVERED DATA

Battery Voltage

Battery Current

Battery Temperature

State of Charge (SOC): Current charge status of the battery, defined in percentage

State of Health (SOH): Ageing status of the battery, loss of capacity over time

Autonomy: Estimated battery duration based on the instantaneous current consumption of the system

NMEA PGNS

DC Detailed Status 127506

Battery Status 127508

Battery Configuration Status 127513

12 VOLT SYSTEMS

- ▼ Two sensors available for 12V batteries
- ▼ IBS is connected to the battery negative pole
- ▼ Measuring line to the positive pole

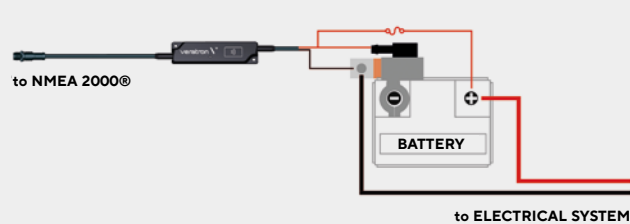

24 VOLT SYSTEMS

- ▼ Series of two 12V batteries
- ▼ IBS is connected to the battery neg. pole of one 12 V battery
- ▼ Fused connections to the 12V and 24V positive poles

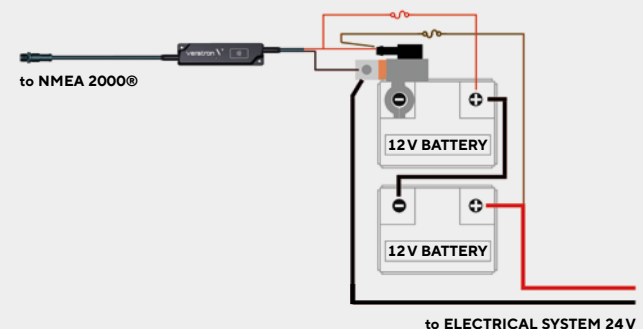



ART. NR. B00070501

2-IN-1 (PRESSURE + OIL TEMPERATURE)

This sensor measures pressure or temperature of transmission or engine oil while providing the data to the **LINKUP**, which translates it to the NMEA 2000® standard.

FACTS AND BENEFITS

- ▼ Interface to the new electronic 2-in-1 sensor
- ▼ Oil Temperature and Pressure in a single sensor
- ▼ Rugged and reliable design derived from the automotive field
- ▼ ASIC-controlled sensor
- ▼ PWM output to transmit both pressure and temperature



NMEA PGNS

Engine Parameters, Dynamic	127489
Transmission Parameters, Dynamic	127493

TECHNICAL DATA

M12 mounting thread
IP 69/K protection class
5V power feed provided by the LinkUp
Temperature accuracy ± 1°K in the 135°C - 160°C range
Pressure accuracy ±0.2 bar (range 0.5 -3 bar), ± 0.1 bar below and ± 0.3 bar above
Temperature range: -40°C + 160°C
Pressure range: 0.5 to 10.5 bar
1 m cable length



ART. NR. B00042401

J1939 GATEWAY

The **LINKUP J1939** will bridge all your CAN engine data, transmitted on the CAN-J1939-Bus, to the NMEA 2000® standard, making all the engine and diagnostic information available for any NMEA 2000®-capable display.

FACTS AND BENEFITS

- ▼ J1939 to NMEA 2000® gateway to bring engine data to your boat network
- ▼ Delivers engine diagnostic to your MFD or smartphone in conjunction with a Veratron GO device
- ▼ Galvanic isolation between J1939 and NMEA 2000® networks
- ▼ Optional Y-shaped adapter cables to interface specific engines

SUPPORTED DATA

Engine Speed	Transm. Oil Temp
Engine Hours	Exhaust Temp
Engine Load	Fuel Level
Engine Oil Temp	Fuel Press
Engine Oil Press	Fuel Rate
Coolant Temp	Inst Fuel Economy
Coolant Press	Alternator Current
Boost Press	Alternator Potential
Percent Torque	Battery Potential
Transm. Oil Press	Transmission Gear

SUPPORTED ALARMS

Low Fuel Press	Low Battery Voltage
Water In Fuel	Engine Overspeed
Low Engine Oil Level	High Gear Oil Temp
Low Engine Oil Press	Low Gear Oil Press
High Boost Press	Low Oil Level
High Coolant Temp	High Oil Temp
Low Coolant Level	Lamps' Status



ART. NR. B00059201

0-5 VOLT

The voltage-type LinkUp gateway provides an easy method to convert vessel and engine information to NMEA 2000®.

FACTS AND BENEFITS

- ▼ 5 V output for sensor feed
- ▼ Designed for electronic sensors
- ▼ Customizable sensor curves
- ▼ Approved for engine compartments
- ▼ Alarms setup + transmission on NMEA 2000®

SUPPORTED DATA

Fuel Level	Boost Pressure
Freshwater Level	Oil Temperature
Wastewater Level	Oil Pressure
Trim Level	Gear Oil Pressure
Rudder Angle	Gear Oil Temp
Coolant Temp	Trim Tabs

SUPPORTED ALARMS

Coolant Temperature
Boost Pressure
Oil Temperature
Oil Pressure
Gear Oil Pressure
Gear Oil Temperature
Low Coolant Level



SENSORS – HIGH PRECISION FOR YOUR SAFETY

Sensors for electronically controlled safety functions are the eyes, ears and antenna of a modern-day high-tech vehicle. Nothing escapes them – neither the smallest temperature deviation inside cooling systems, nor the monitoring of engine and gear oil temperature. Intelligent safety systems are inconceivable without them. Over the past 60 years, we have continuously refined and perfected our sensors that now have reached an utmost degree of precision.



Analog Wind Sensor

ANALOG WIND SENSOR

The legacy wind vane turns in the direction of the wind and steers the wind direction gauge. The wind cups record the relative wind speed which in turn is displayed on the wind speed gauge. Also compatible with VDO Marine "Standard" & "Logic" series.

VOLTAGE	ARTICLE NR
12-24 V	A2C59501983



Rudder Angle Sensor

RUDDER ANGLE SENSORS

SINGLE STATION

VOLTAGE	RESISTANCE	ARTICLE NR
12-24 V	10-180 Ω	A2C1102950001

DUAL STATION (FLY BRIDGE)

VOLTAGE	RESISTANCE	ARTICLE NR
12-24 V	5-90 Ω	A2C1102960001

DISCOVER
MORE





FUEL LEVEL SENSORS

AFTERMARKET PACKAGE

Fuel Level Sensor (resistive) with adjustable lever, sealing kit NO5-801-432

SINGLE STATION

VOLT.	SIGN. RANGE empty / full	LENGTH adjustable	ARTICLE NR
12-24 V	3 - 180 Ω	150-600 mm	226-801-015-001G
12-24 V	240-33.5 Ω	150-600 mm	A2C1364580001

DUAL STATION (FLY BRIDGE)

VOLT.	SIGN. RANGE empty / full	LENGTH adjustable	ARTICLE NR
12-24 V	2 - 90 Ω	150-600 mm	N02-240-106



AMMETER SHUNT

A shunt is a resistor that causes a small voltage drop. This voltage drop in mVolt is proportional with the current in ampere that goes through the resistor. This voltage is measured by the Ammeter. The advantage of the shunt is that thick wires are no longer needed at a high current (>10 A).

To measure the total flow you only need two thin wires from the measuring instrument to the shunt in the earth connection of the main system.

VOLT.	RANGE	INPUT	ART. NR
12-24 V	-60/+60 A	60 mV	A2C59514043
12-24 V	-150/+150 A	60 mV	A2C59514047



Intelligent safety systems
are inconceivable without them





DIP-PIPE LEVEL SENSOR / ARTICEL NUMBERS

LENGTH	SIGNAL RANGE		
	90 - 4 Ω	0 - 180 Ω	240 - 33 Ω
150 mm	A2C1749300001	A2C1720030001	A2C1746020001
160 mm	A2C1749310001	A2C1742410001	A2C1746030001
170 mm	A2C1749370001	A2C1742980001	A2C1746040001
180 mm	A2C1749950001	A2C1744170001	A2C1746060001
190 mm	A2C1750030001	A2C1744180001	A2C1746100001
200 mm	A2C1750040001	A2C1744190001	A2C1746120001
210 mm	A2C1750100001	A2C1744200001	A2C1746130001
220 mm	A2C1750120001	A2C1744210001	A2C1746140001
230 mm	A2C1750130001	A2C1744220001	A2C1746150001
240 mm	A2C1750170001	A2C1744230001	A2C1746170001
250 mm	A2C1750190001	A2C1744240001	A2C1746190001
260 mm	A2C1750200001	A2C1744250001	A2C1746220001
270 mm	A2C1750210001	A2C1744260001	A2C1746300001
280 mm	A2C1750220001	A2C1744270001	A2C1746390001
290 mm	A2C1750230001	A2C1744280001	A2C1746420001
300 mm	A2C1750240001	A2C1744290001	A2C1746450001
310 mm	A2C1750250001	A2C1744300001	A2C1746990001
320 mm	A2C1750260001	A2C1744310001	A2C1747000001
330 mm	A2C1750270001	A2C1744320001	A2C1747020001
340 mm	A2C1750280001	A2C1744350001	A2C1747030001
350 mm	A2C1750290001	A2C1744360001	A2C1747050001
360 mm	A2C1750300001	A2C1744370001	A2C1747060001
370 mm	A2C1750310001	A2C1744380001	A2C1747080001
380 mm	A2C1750320001	A2C1744390001	A2C1747090001
390 mm	A2C1750330001	A2C1744400001	A2C1747130001
400 mm	A2C1750340001	A2C1744410001	A2C1747140001
410 mm	A2C1750350001	A2C1744420001	A2C1747150001
420 mm	A2C1750360001	A2C1744430001	A2C1747160001
430 mm	A2C1750380001	A2C1744440001	A2C1747170001
440 mm	A2C1750390001	A2C1744450001	A2C1747190001
450 mm	A2C1750420001	A2C1744460001	A2C1747200001
460 mm	A2C1750440001	A2C1744470001	A2C1747210001
470 mm	A2C1750460001	A2C1744480001	A2C1747220001
480 mm	A2C1750470001	A2C1745780001	A2C1747230001
490 mm	A2C1750490001	A2C1745790001	A2C1747240001
500 mm	A2C1750500001	A2C1745800001	A2C1747250001
550 mm	A2C1750530001	A2C1745810001	A2C1747260001
600 mm	A2C1750570001	A2C1720100001	A2C1747270001
650 mm	A2C1750620001	A2C1745820001	A2C1747280001
700 mm	A2C1750650001	A2C1745830001	A2C1747290001
750 mm	A2C1750730001	A2C1745840001	A2C1747300001
800 mm	A2C1750740001	A2C1745880001	A2C1747340001
850 mm	A2C1750750001	A2C1745890001	A2C1747350001
900 mm	A2C1750760001	A2C1745900001	A2C1747360001
950 mm	A2C1750770001	A2C1745910001	A2C1747370001
1000 mm	A2C1750790001	A2C1745920001	A2C1747380001
1050 mm	A2C1750810001	A2C1745930001	A2C1747390001
1100 mm	A2C1750840001	A2C1745940001	A2C1747410001
1150 mm	A2C1750850001	A2C1745950001	A2C1747420001
1200 mm	A2C1750860001	A2C1745960001	A2C1747430001
1400 mm	B00068601	-	-

DIP-PIPE LEVEL SENSORS

The Dip-Pipe Level Sensor is ideal for usage in fuel tanks. Its 38 mm diameter vertical tube contains a float inside, which measures the liquid's level. Small holes at the top and bottom of the tube act as a baffle to fuel sloshing around in the fuel tank, so the float position remains stable at any sea state. The sensors are made in various lengths starting from 150 mm up to 1200 mm - when selecting the sensor, make sure that the length chosen is at least 4 mm from the base of the fuel tank once fitted.

SPECIFICATIONS

- ▼ TE Superseal Connector IP67
- ▼ Compensation chamber
- ▼ Flange: PA66 GF30
- ▼ Wiring harness with length of 200 mm
- ▼ 3 Signal ranges: 90-4 Ω, 0- 180 Ω, 240- 33 Ω
- ▼ Length: 150 mm - 1200 mm
- ▼ Mounting diameter: 54 mm
- ▼ IP67 protection rating

AFTERMARKET PACKAGE

Dip-Pipe Level Sensor, Safety and Installation Instructions, Installation Kit A2C17593300

ACCESSORIES

6 m Wiring A2C1756300001

FLANGE ADAPTER KIT

The Flange Adapter Kit can be adapted to our brand-new Fuel Level Sensor replacing the old 80mm sensor. A cross reference list (provided by our sales offices) will allow you to find the correct sensor replacing the defective one. Our Flange can be adapted to any of our liquid level sensors.

This is a complete solution in case of defective Fuel Level Sensors.



ART.NR. B00001201



NMEA 2000® Liquid Level Sensor (capacitive)

NMEA 2000® LIQUID LEVEL SENSOR (CAPACITIVE)

Our NMEA 2000® Liquid Level Sensor, with adjustable dip, provides you with fresh and waste water level.

VOLTAGE	LENGTH	ARTICLE NR
12 V	200 - 600 mm	B00041201
12 V	600 - 1200 mm	B00041401
12 V	1200 - 1500 mm	B00041501



Fresh Water Capacitive Sensor

FRESH WATER LEVEL SENSORS

AFTERMARKET PACKAGE

Fresh Water Level Sensor (capacitive) with adjustable dip, sealing kit N05-001-370

VOLT.	SIGN. RANGE	LENGTH	ARTICLE NR
12-24 V	4 - 20 mA	80 - 600 mm	N02-240-402
12-24 V	4 - 20 mA	600 - 1200 mm	N02-240-404
12-24 V	4 - 20 mA	1200 - 1500 mm	N02-240-406



Waste Water Capacitive Sensor

WASTE WATER LEVEL SENSORS

AFTERMARKET PACKAGE

Waste Water Level Sensor (capacitive) with adjustable dip, sealing kit N05-016-930

VOLT.	SIGN. RANGE	LENGTH	ARTICLE NR
12-24 V	4 - 20 mA	200 - 600 mm	N02-240-902
12-24 V	4 - 20 mA	600 - 1200 mm	N02-240-904
12-24 V	4 - 20 mA	1200 - 1500 mm	N02-240-906

COMBINED OIL PRESSURE / TEMPERATURE SENSOR



RANGE	VOLT.	SIGNAL RANGE	THREAD	ARTICLE NR
-40°/+160° C 0.5 - 10.5 bar	5 V	PWM	M12	B00084301

PYROMETER SENSOR

THERMOCOUPLE ELEMENT

RANGE	TERMINALS	ARTICLE NR
100-900°C 250-1650°F	Red = Negative Yellow = Positive	N03-320-264



PYROMETER NMEA 2000® KIT

ARTICLE NR: B00042301 (LinkUp gateway included)

CONNECTING CABLE

LENGTH	TERMINALS	ARTICLE NR
6 m	White = Negative Blue = Positive	B00063201

THREADED BUSHING FOR WELDING TO MANIFOLD

ARTICLE NR: N03-320-266

BATTERY SENSOR

INTELLIGENT BATTERY SENSOR (IBS)

The Intelligent Battery Sensor (IBS) is the key element of vehicle energy management. The IBS reliably and accurately measures the battery parameters: voltage, current and temperature.

NOMINAL VOLTAGE	MAX. CAPACITY	ARTICLE NR
12 V	250 Ah	B00043901
12 V	500 Ah	B00084201
24 V	250 Ah	B00072101

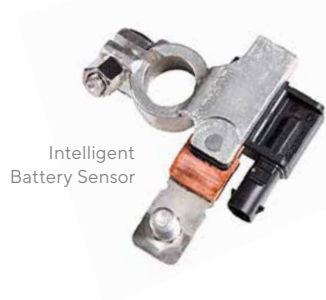



KITS – SMALL BOX, BIG CAPABILITY.



VL FLEX IBM KIT

The VL Flex IBM Kit includes:

- ▼ VL Flex 52 instrument
- ▼ Intelligent Battery Sensor (IBS) (incl. Battery pole adapter)
- ▼ 6-meter long wiring harness

Delivered Data:

- ▼ Voltage
- ▼ Current
- ▼ Battery temp.
- ▼ State of charge
- ▼ Battery health
- ▼ Autonomy

VOLTAGE	ARTICLE NR
12 V	B00084701
24 V	B00084801

BENEFITS

- ▼ Ready for connecting to Veratron dip-pipe liquid level sensors
- ▼ Continuous monitoring of battery status
- ▼ Support of battery maintenance
- ▼ Easy configuration with the mobile app



Everything you need, to know your battery health and status at any time!



VMH 35 OUTBOARD ENGINE KITS

VMH 35 Outboard Engine Kits include:

- ▼ VMH 35 Display
- ▼ IBS 12V 250 Ah with battery adapter
- ▼ Wire harness 6m with connectors for level sensor and IBS
- ▼ Bullets terminals for tachometer trim and power supply

VARIANTS	ARTICLE NR
VMH 35 Kit	B00085502
VMH 35 Kit 0-5 V	B00143502



Upgrade your boat to the digital world!

SMART KIT

The **SMART KIT** is composed of an **OCEANLINK™** 4.3" or 7" TFT Display, our new GPS module **VERATRON GO** and all the necessary cables for installation and connection. All your data are displayed on the TFT Display.

VARIANTS	ARTICLE NR
Smart Kit 4.3"	A2C1352150004
Smart Kit 7"	A2C1865330002



NAVIGATION KIT

Complex boats need a smart solution. And we have it. OceanLink™ display is the only product on the market able to interpret CAN, NMEA 2000® and analog signals without any additional external device.

The Navigation Kit is the solution! Our Navigation Kits will become an essential crew member which ensures top performance in open seas, even in the most extreme situations.

ALL IN ONE BOX

All you need is in one box including wiring harness and terminators. All products are REACH and RoHS compliant and NMEA 2000® certified.

ARTICLE NR

A2C1352150002

The Navigation Kit includes:

- ▼ Wind Sensor NMEA 2000®
- ▼ NMEA 2000® Triducer Sensor
- ▼ OceanLink™ 4.3" TFT Display
- ▼ NMEA 2000® Cable 30 m
- ▼ NMEA 2000® Cable 6 m
- ▼ NMEA 2000® Terminator Female
- ▼ NMEA 2000® Inline Terminator
- ▼ 2x NMEA 2000® T-Splitter



NMEA 2000® Wind Sensor



OceanLink™ 4.3" TFT Display



NMEA 2000® Triducer Sensor

SAILING KIT

Have your boat ready for the sailing season with the Sailing Kit, the fundamental setting for your sailing boat.

The Sailing Kit brings all the necessary tools for your sailing journeys. All you need is in one box including wiring harness and terminators. All products are REACH, RoHS and NMEA 2000® compliant. The Kit provides the elementary yet essential set-up to make your sailing trips safe while having access to all necessary information.

The Kits products are a must have on a sailing boat and offer a high functionality and readability, thanks to the analog displays.



ARTICLE NR

A2C3935310001



Easy to install, the Sailing Kit provides necessary data to assist you during your journey.

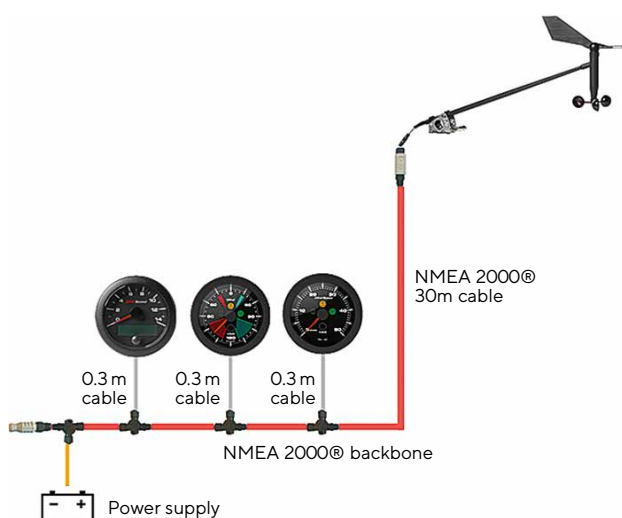

The Sailing Kit includes:









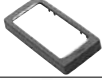

- ▼ 1 OceanLink™ GPS Speedometer
- ▼ 1 wind sensor
- ▼ OceanLink™ Navigation gauge wind angle
- ▼ OceanLink™ Navigation gauge wind speed

The NMEA 2000® certified GPS Speedometer has an embedded GPS receiver for speed and heading indications, avoiding the need of additional sensors on board. It also Serves for calculation of true wind data in combination with the navigation wind gauges featuring an infrared push button for a fast switch from apparent to true wind. The Sailing Kit is low-power consuming and lead-free for our planet's well-being.





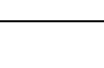









ACCESSORIES

ACQUALINK™ ACCESSORIES

ITEM SPECIFICS	ARTICLE NR	IMAGE
Bezel TFT 4.3", black	A2C59501967	
Bezel TFT 4.3", white	A2C3983920001	
Bezel TFT 7", black	A2C59501968	
Bezel TFT 7", white	A2C3995200001	
Bezel NavControl, black	A2C1156050001	
Bezel NavControl, white	A2C3997600001	
Spinlock nut, 52 mm	A2C5205947101	
Spinlock nut, 110 mm	A2C5323888101	
Silicone cover for 7" TFT Display	A2C59501973	
Silicone cover for NavControl	A2C59501974	

OCEANLINK™ ACCESSORIES







ITEM SPECIFICS	ARTICLE NR	IMAGE
Spinlock nut, 52 mm	A2C5205947101	
Spinlock nut, 85 mm	A2C1376090001	
Round Bezel 52 mm, black	A2C1141440001	
Round Bezel 52 mm, chrome	A2C5336487001	
Round Bezel 52 mm, white	A2C1352110001	
Round Bezel 85 mm, black	A2C1111380001	
Round Bezel 85 mm, chrome	A2C1141580001	
Round Bezel 85 mm, white	A2C1352140001	
Bezel TFT 7", black	A2C1697530001	
Bezel TFT 7", white	A2C1697540001	
Suncover for OL43 display	B00129601	
Silicone cover for 7" TFT Display	A2C59501973	

CAN BUS, ACQUALINK™ AND OCEANLINK™ INSTALLATION ACCESSORIES

ITEM SPECIFICS	ARTICLE NR	IMAGE
VDO Bus to NMEA 2000® Adapter	A2C9624490001	
VDO Bus Cable	0.3 m A2C9624460001	
	2 m A2C3880570001	
	5 m A2C9624500001	
	10 m A2C9624510001	
VDO Bus Gender Changer	A2C3880550001	
VDO Bus Termination Resistor	A2C9979390001	
NMEA 2000® Power Cable	A2C3931290001	
NMEA 2000® T Splitter	A2C3931270002	
	0.5 m A2C9624370001	
	2 m A2C9624380001	
	6 m A2C9624400001	
NMEA 2000® Cable	10 m A2C9624420001	
	30 m* A2C59501950	
	6 m A2C9624400001	
	10 m A2C9624420001	
NMEA 2000® Terminator Female	A2C3931060001	
NMEA 2000® Terminator Male	A2C3931100001	
NMEA 2000® Inline Terminator	A2C3931250001	
NMEA 2000® Infield Installation Connector Female	A2C3930850001	
NMEA 2000® Infield Installation Connector Male	A2C3931050001	
Infield Installation Connector VDO Bus/Wind Sensor Cable	A2C3880490001	
J1939 Termination Resistor, Inline J1939	A2C9979420001	
Video cable 0.3 m for 7" AcquaLink™	A2C9979110001	
Video cable 0.3 m for 7" OceanLink™	A2C1845710001	
32 pin power cable for dual engine	A2C1766930001	
32 pin power cable for single engine	A2C1821960001	
Power cable NavBox	A2C9875610001	
26 pin NavBox analog harness	A2C9875480001	
MediaBox cable harness	A2C1313150001	

* one end without connector for easier routing

CAN BUS, ACQUALINK™ AND OCEANLINK™ INSTALLATION ACCESSORIES

ITEM SPECIFICS	ARTICLE NR	IMAGE
Power cable and data cable for OceanLink™ Face-lift Master Gauges 85 mm	A2C1433330001	
EasyLink connecting cable	A2C59500139	
Power cable and data cable for OceanLink™ TFT 7" Engine 1	A2C1507870001	
Data cable for OceanLink™ Master TFT 7" Engine 2	A2C1992110001	
Adapter Cable IBS 12 V	B00090601	
Adapter Cable IBS 24 V	B00090701	
Adapter Cable LinkUp - Volvo Penta ¹	B00102701	
Adapter Cable LinkUp - Yanmar ²	B00102801	
Battery Pole Adapter for IBS 12/24 V, 250 Ah	B00068201	
Battery Pole Adapter for IBS 12 V, 550 Ah	B00068401	









**9 different styling
rings available**



VIEWLINE BEZELS

PROFILE	COLOR	ARTICLE NR
Ø 52 MM		
Flat	Black	A2C5318604001
	White	A2C5318602201
	Chrome	A2C5318602301
Triangular	Black	A2C5318602401
	White	A2C5318602501
	Chrome	A2C5318602601
Round	Black	A2C5318602701
	White	A2C5318602801
	Chrome	A2C5318602901
Ø 85 MM		
Flat	Black	A2C5319291101
	White	A2C5319291201
	Chrome	A2C5319291001
Triangular	Black	A2C5319291701
	White	A2C5319292001
	Chrome	A2C5319291801
Round	Black	A2C5319291301
	White	A2C5319291601
	Chrome	A2C5319291401
Ø 110 MM		
Flat	Black	A2C5321074501
	White	A2C5321074601
	Chrome	A2C5321074701
Triangular	Black	A2C5321076301
	White	A2C5321076401
	Chrome	A2C5321076501
Round	Black	A2C5321074901
	White	A2C5321076001
	Chrome	A2C5321076101

VIEWLINE ACCESSORIES

ITEM SPECIFICS	ARTICLE NR	IMAGE
Spinlock nut 52 mm	A2C5205947101	
Spinlock nut 80/85 mm	A2C5321223801	
Spinlock nut 110 mm	A2C5323888101	
Pushbutton for LCD 13.6 mm	A2C1028400001	
Connector set 8 pin	A2C59510850	
Connector set 14 pin	A2C59510851	
Adapter cable for 52 mm 5x AMP taps, 6.3 mm 2x AMP taps, 2.8 mm	A2C59510852	
Adapter cable 8-pole for temperature, pressure, fuel level, trim, pyrometer, outside temperature, fresh water, blackwater, tachometer, speedometer	A2C59512947	
Ammeter ViewLine Harness	A2C59512679	
Adapter cable 14 pole for tachometer with LCD	A2C59512950	
VL GPS Speed and VL Flex NMEA harness	A2C9582260001	
Bracket assembly mounting set	A2C59510854	
Blindplug for Ø 52 mm	A2C5312164501	
ViewLine adapter cable to WWG	B00013402	

SENSOR ACCESSORIES

ITEM SPECIFICS	ARTICLE NR	IMAGE
Mast Cable (Analog Wind Sensor)	10 m	
	30 m	
Dip-Pipe Sensor 6 m Wiring Harness	A2C1756300001	

SALES OFFICES

Veratron AG

/
Industriestrasse 18
9464 Rüthi
Switzerland

Veratron US Inc.

/
Suite 127
250 N Sunny Slope Rd
Brookfield, WI 53005
USA

Veratron Japan K.K.

/
6-12-20, Shimoochiai
Chuo-ku, Saitama-city
338-0002 Japan

OUTDOOR INSTRUMENTATION ENGINEERED IN SWITZERLAND



Veratron AG / Industriestrasse 18 / 9464 Rüthi / Switzerland
T +41 71 7679 111 / info@veratron.com / veratron.com

The information provided in this brochure contains only general descriptions or performance characteristics, which do not always apply as described in case of actual use or which may change as a result of further development of the products. This information is merely a technical description of the product. It is not meant or intended to be a special guarantee for a particular quality or particular durability. An obligation to provide the respective characteristics shall only exist if expressly agreed in the terms of contract. We reserve the right to make changes in availability as well as technical changes without prior notice.

Veratron AG / English © 2024