

# 1.8" PENDANT LED

## ARCHITECTURAL LED LUMINAIRE DROP CEILING

**⚠ RISK OF FIRE AND ELECTRICAL SHOCK. FIXTURE MUST BE INSTALLED BY A QUALIFIED ELECTRICIAN ONLY IN ACCORDANCE WITH NATIONAL, LOCAL BUILDING AND ELECTRICAL CODES. DISCONNECT POWER AT ELECTRICAL PANEL BEFORE SERVICING.**

### ▶ POWER FEED

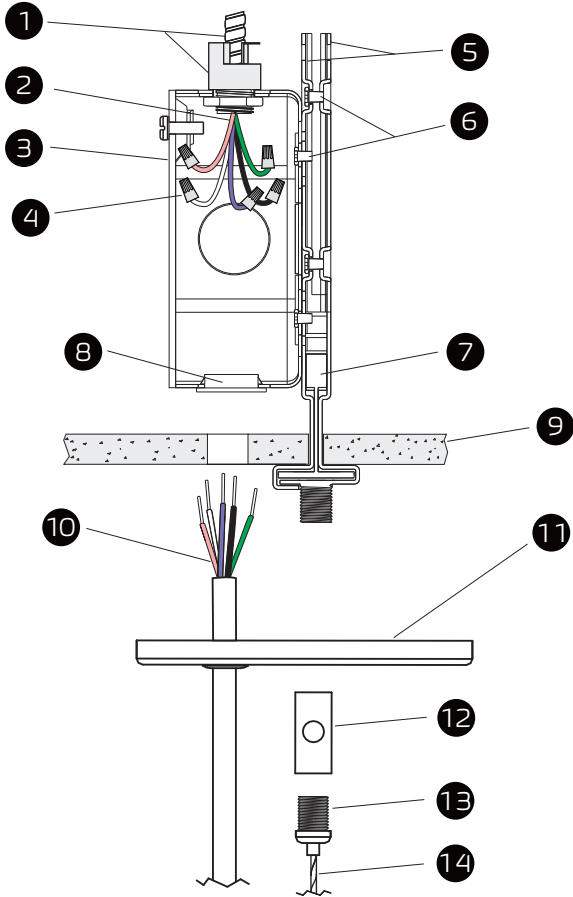

### ▶ NON POWER SUSPENSION

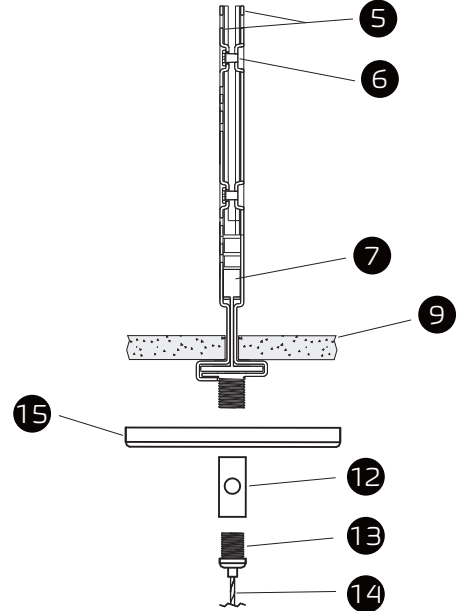

### ▶ PARTS LIST

- 1 Armored Cable & Connector (By Others)
- 2 Power Cord (By Others)
- 3 4" Octagon Junction Box
- 4 Wire Nut
- 5 Assembled T-grid Clips
- 6 Screw 6#\*4
- 7 T-grid (By Others)
- 8 Plastic Grommet
- 9 Ceiling Tile (By Others)
- 10 Power Cord
- 11 4" Canopy Power Feed
- 12 Cable Holder
- 13 Strain Relief Thread Nut
- 14 Aircraft Cable
- 15 2" Canopy

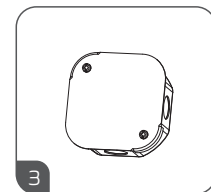

4" Octagon Junction Box

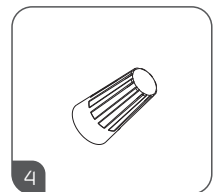

Wire Nut

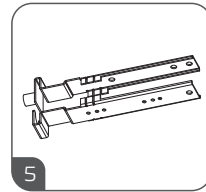

Assembled T-grid Clips

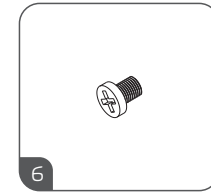

Screw 6#\*4

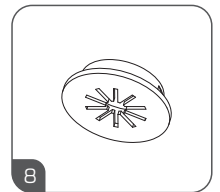

Plastic Grommet

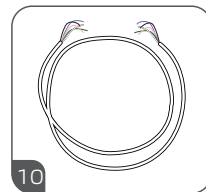

Power Cord

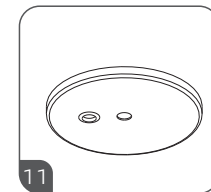

4" Canopy Power Feed

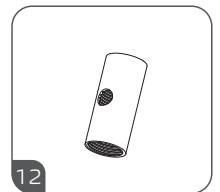

Cable Holder

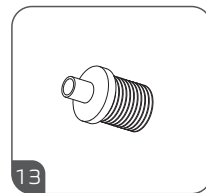

Strain Relief Thread Nut

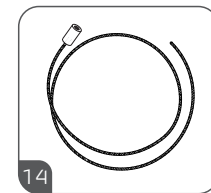

Aircraft Cable

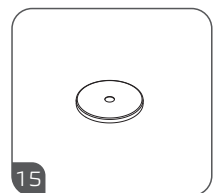

2" Canopy

# 1.8" PENDANT LED

## ARCHITECTURAL LED LUMINAIRE DRY CEILING

**! RISK OF FIRE AND ELECTRICAL SHOCK. FIXTURE MUST BE INSTALLED BY A QUALIFIED ELECTRICIAN ONLY IN ACCORDANCE WITH NATIONAL, LOCAL BUILDING AND ELECTRICAL CODES. DISCONNECT POWER AT ELECTRICAL PANEL BEFORE SERVICING.**

### ▶ POWER FEED

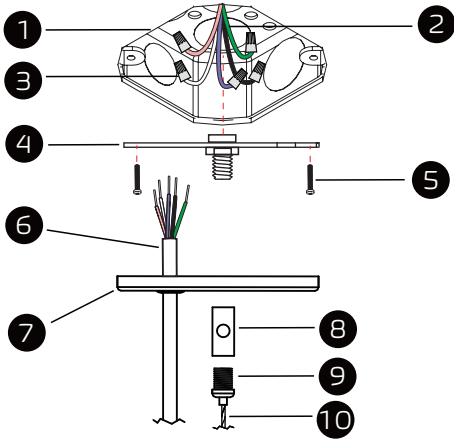

### ▶ NON POWER SUSPENSION

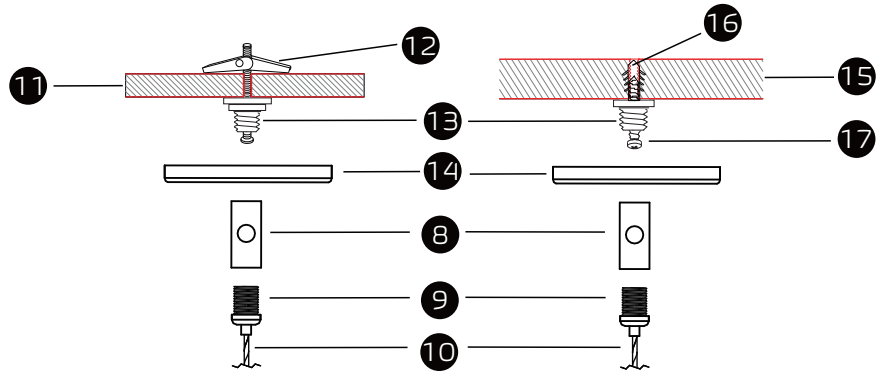

### ▶ PARTS LIST

- 1 4" Octagon Junction Box (By Others)
- 2 Power Cord (By Others)
- 3 Wire Nut
- 4 Junction Box Crossbar
- 5 Screw PM4\*22
- 6 Power Cord
- 7 4" Power Canopy Kit
- 8 Cable Holder
- 9 Strain Relief Thread Nut
- 10 Aircraft Cable
- 11 Drywall Ceiling (By Others)
- 12 Butterfly Drywall Anchor
- 13 Crimp Stud
- 14 2" Canopy
- 15 Solid Ceiling (By Others)
- 16 Anchor
- 17 Screw PA4\*30

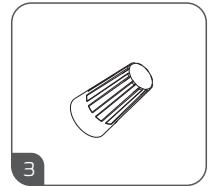

Wire Nut

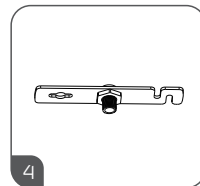

Junction Box Crossbar

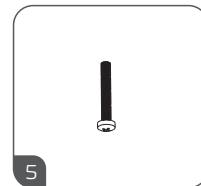

Screw PM4\*22

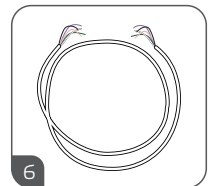

Power Cord

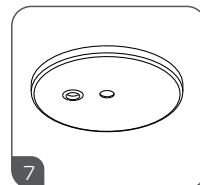

4" Canopy Power Feed

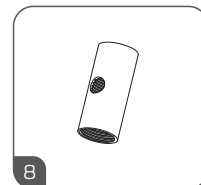

Cable Holder



Strain Relief Thread Nut

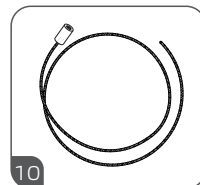

Aircraft Cable

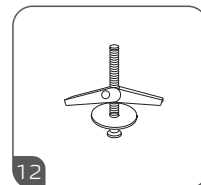

Butterfly Drywall Anchor

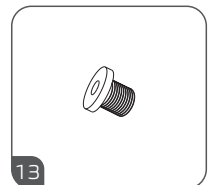

Crimp Stud

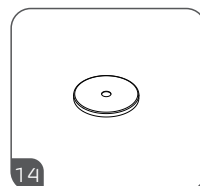

2" Canopy



Anchor



Screw PA4\*30

# 1.8" PENDANT LED

## ARCHITECTURAL LED LUMINAIRE INDEPENDENT INSTALLATION

**! RISK OF FIRE AND ELECTRICAL SHOCK. FIXTURE MUST BE INSTALLED BY A QUALIFIED ELECTRICIAN ONLY IN ACCORDANCE WITH NATIONAL, LOCAL BUILDING AND ELECTRICAL CODES. DISCONNECT POWER AT ELECTRICAL PANEL BEFORE SERVICING.**

### IMPORTANT

1. Read all instructions.
2. Install in accordance with national and local electrical code regulations.
3. This product is intended to be installed and serviced by a qualified, licensed electrician.
4. Do not install in wet locations. For dry and damp use only.
5. Turn off electrical power before installing or servicing fixture in any way.
6. To reduce the risk of fire and overheating, make sure all connections are tight.
7. Under no circumstances can the lighting fixture be covered with heat insulation gasket or similar materials.
8. The maximum connection of each input line is 40FT(1200CM) in 120AC, 80FT (2400CM) in 230AC, 100FT(3000CM) in 277AC.

### SHOCK HAZARD

**! May result in serious injury or death. Turn power OFF at circuit breaker prior to installation or servicing.**

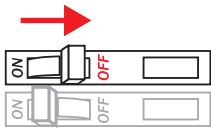

### PRE-INSTALLATION

#### Assemble Power Cord

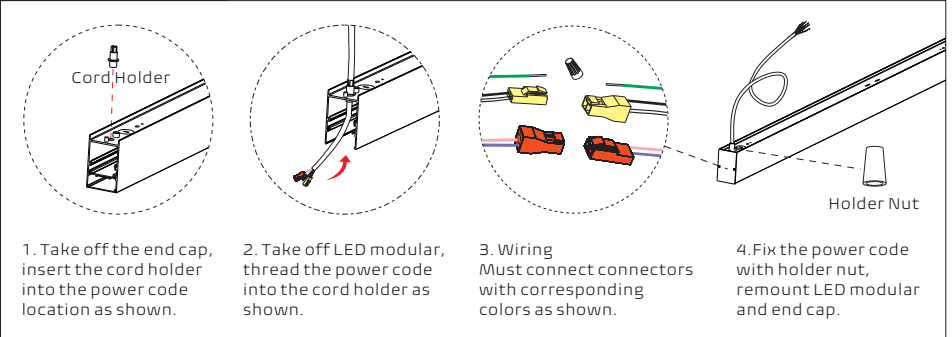

### INDEPENDENT INSTALLATION

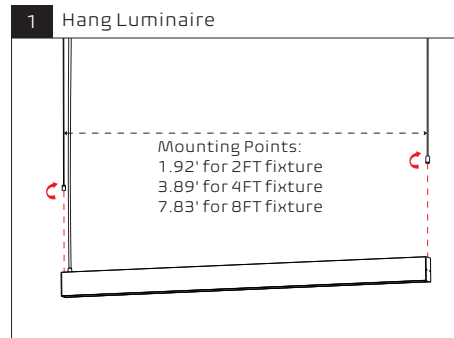

Screw both bottom parts of aircraft cables clockwise and secure them on the top of housing making sure they hang the lights.

Note: Adjust the height of luminaire. Luminaire can be raised by pulling cable through the gripper and can be lowered by depressing the top cylinder on the gripper which pulls the luminaire down.

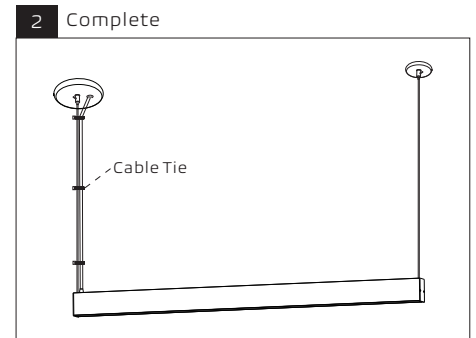

Use the cable tie to keep the electric wire going up along with the wire rope.

### WIRING

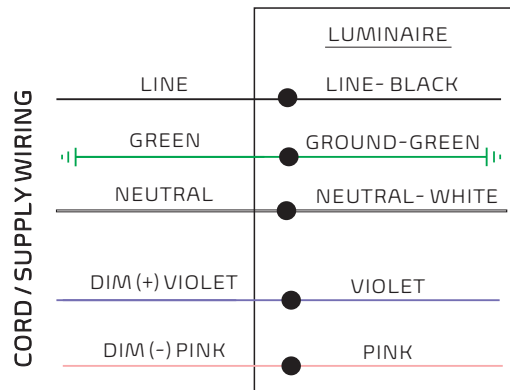

Please isolate two dimming wires by P2 terminal individually if no need dimming;  
**MUST connect wires with corresponding colors as shown.**

# 1.8" PENDANT LED

## ARCHITECTURAL LED LUMINAIRE MULTIPLE LUMINAIRES CONNECTION

**! RISK OF FIRE AND ELECTRICAL SHOCK. FIXTURE MUST BE INSTALLED BY A QUALIFIED ELECTRICIAN ONLY IN ACCORDANCE WITH NATIONAL, LOCAL BUILDING AND ELECTRICAL CODES. DISCONNECT POWER AT ELECTRICAL PANEL BEFORE SERVICING.**

### JOINER OPTIONS

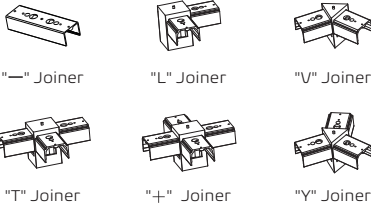

Noted: It needs 2 inputs if using joiner "T", "+ " and "Y".

### ACCESSORY



Noted: Silicone Seal is used to seal seams that may appear at both ends of luminaires when multiple connections.

### BEFORE CONNECTING

#### Disassemble luminaires

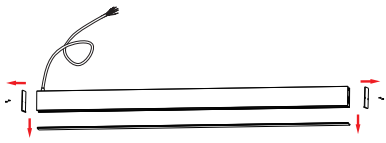

#### Start of run (SoR):

Take off both end caps and PC diffuser, assemble the power cord according to page 3.



#### Middle of run (MoR):

Take off both end caps and PC diffuser

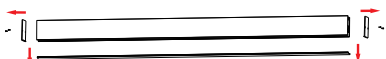

#### End of run (EoR):

Take off both end caps and PC diffuser

### LINE CONNECTION

#### 1 Hang luminaire and wiring - SoR

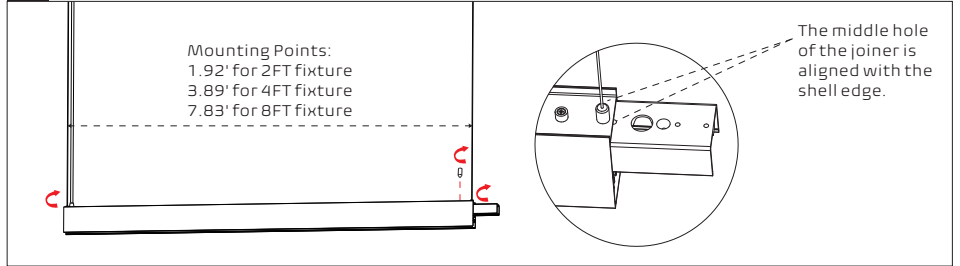

1-1: Screw both bottom parts of aircraft cables clockwise and secure them on the top of housing making sure they hang the lights.

1-2: Insert the joiner "—" into luminaire from one side and fix it with screws.

#### ▲ Adjust the height of luminaire.

Luminaire can be raised by pulling cable through the gripper and can be lowered by depressing the top cylinder on the gripper which pulls the luminaire down.

#### 2 Repeat Hang and join steps - MoR to EoR

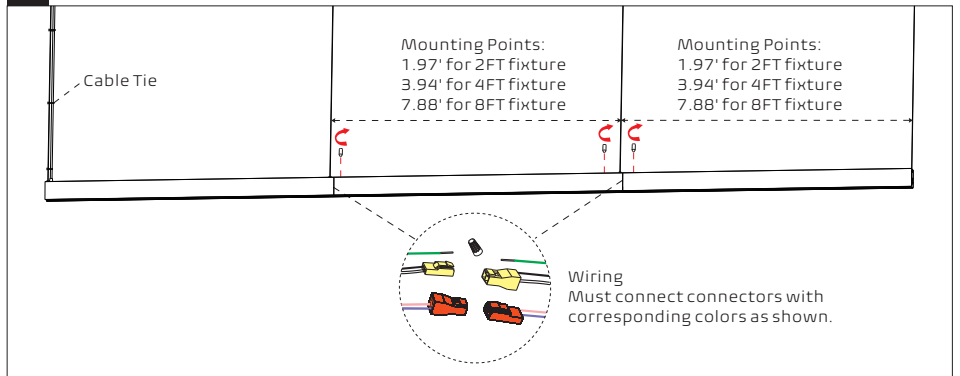

2-1: Connect the quick connectors properly.

2-2: Zip tight power cord & aircraft suspension cable with the cable tie.

#### 3 Reload diffusers and end caps

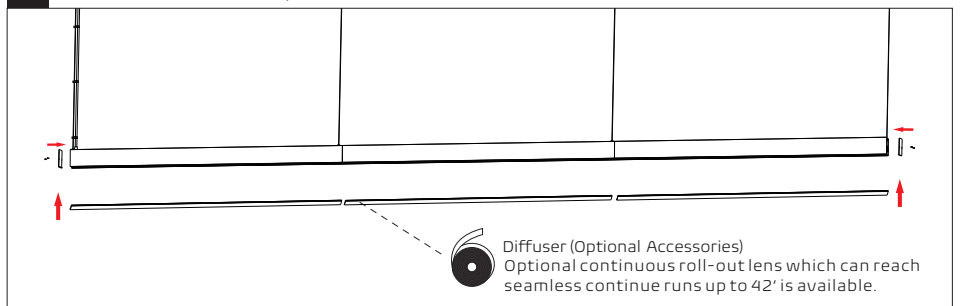

3-1: Reload the PC diffusers into the housing in turn.

3-2: Reload the end caps and fix with screws.

#### 4 Complete

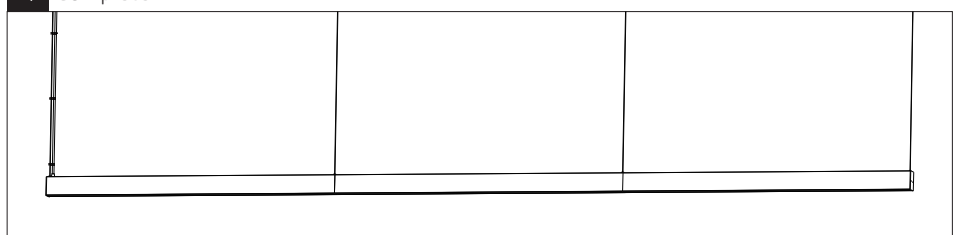

**⚠ RISK OF FIRE AND ELECTRICAL SHOCK. FIXTURE MUST BE INSTALLED BY A QUALIFIED ELECTRICIAN ONLY IN ACCORDANCE WITH NATIONAL, LOCAL BUILDING AND ELECTRICAL CODES. DISCONNECT POWER AT ELECTRICAL PANEL BEFORE SERVICING.**

### L SHAPE CONNECTION

- ▲ For "T", "+", "Y" shape or other geometric shapes, all subject to the "L" shape installation
- ▲ It needs 2 inputs if using joiner "T", "+" and "Y".

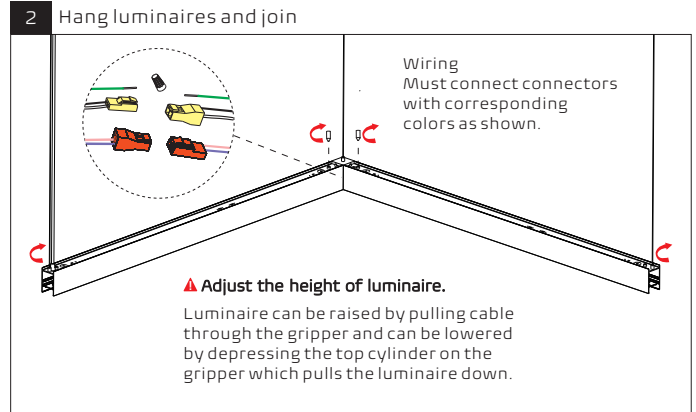
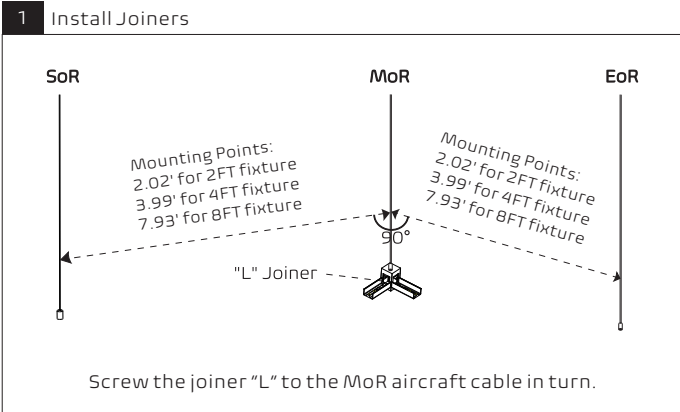

- 2-1: Screw aircraft cables clockwise and secure them, making sure they hang the lights.  
2-2: Insert the joiner "L" into housing, and connect the quick connectors properly  
2-3: Fix the joiner to the housing with screws.

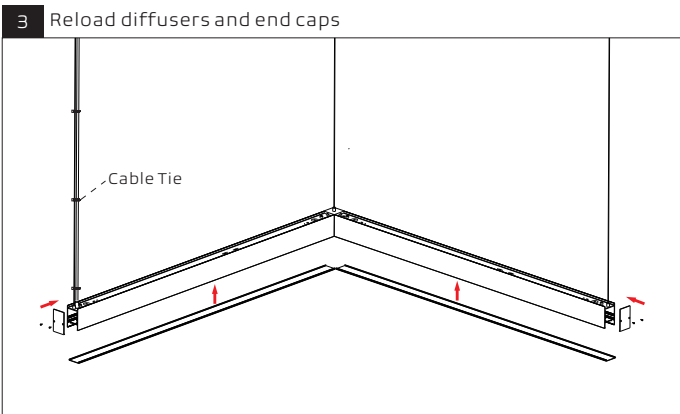

- 3-1: Zip tight power cord & aircraft suspension cable with the cable tie.  
3-2: Reload the PC diffusers into the housing and fix the end caps with screws.

