

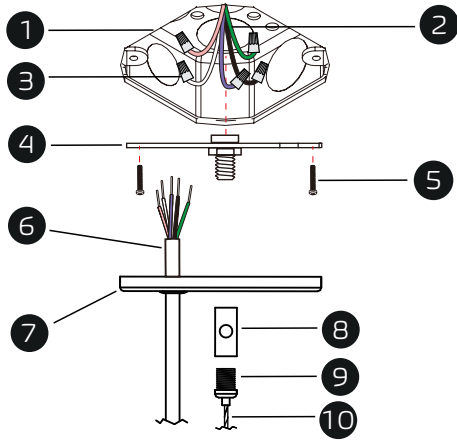

▶ POWER FEED

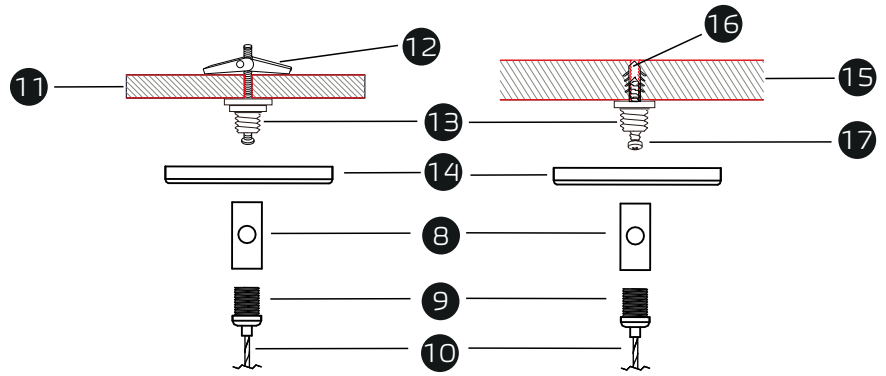

▶ NON POWER SUSPENSION



▶ PARTS LIST

- 1 4" Octagon Junction Box (By Others)
- 2 Power Cord (By Others)
- 3 Wire Nut
- 4 Junction Box Crossbar
- 5 Screw PM4*22
- 6 Power Cord
- 7 4" Power Canopy Kit
- 8 Cable Holder
- 9 Strain Relief Thread Nut
- 10 Aircraft Cable
- 11 Drywall Ceiling (By Others)
- 12 Butterfly Drywall Anchor
- 13 Crimp Stud
- 14 2" Canopy
- 15 Solid Ceiling (By Others)
- 16 Anchor
- 17 Screw PA4*30

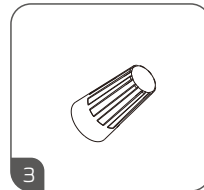

Wire Nut

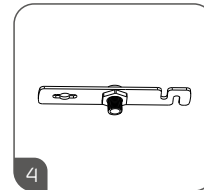

Junction Box Crossbar

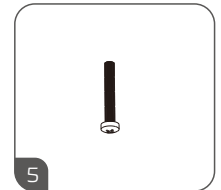

Screw PM4*22

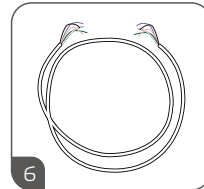

Power Cord

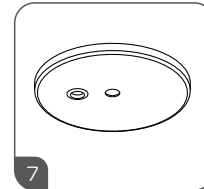

4" Canopy Power Feed

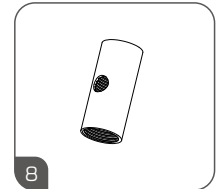

Cable Holder

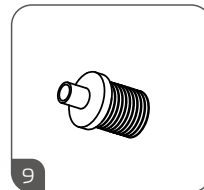

Strain Relief Thread Nut

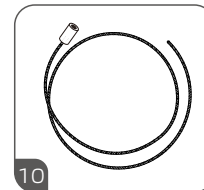

Aircraft Cable

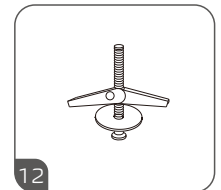

Butterfly Drywall Anchor

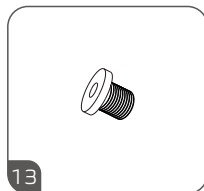

Crimp Stud

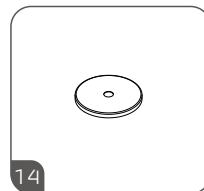

2" Canopy

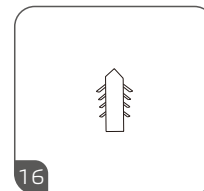

Anchor

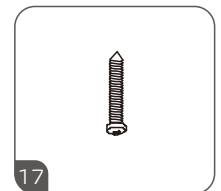

Screw PA4*30

WARNING:

 RISK OF FIRE AND ELECTRICAL SHOCK. FIXTURE MUST BE INSTALLED BY A QUALIFIED ELECTRICIAN ONLY IN ACCORDANCE WITH NATIONAL, LOCAL BUILDING AND ELECTRICAL CODES. DISCONNECT POWER AT ELECTRICAL PANEL BEFORE SERVICING.



▶ POWER FEED

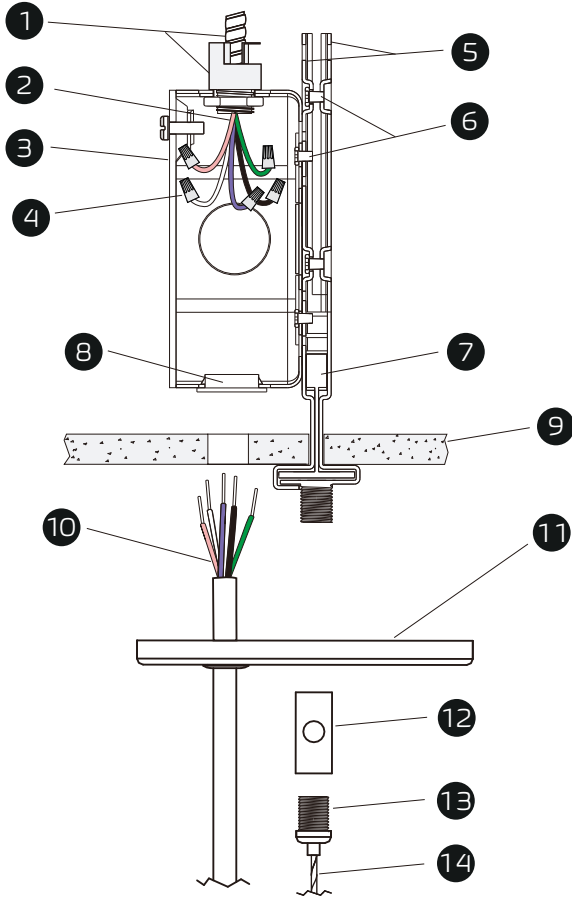

▶ PARTS LIST

- 1 Armored Cable & Connector (By Others)
- 2 Power Cord (By Others)
- 3 4" Octagon Junction Box
- 4 Wire Nut
- 5 Assembled T-grid Clips
- 6 Screw 6#*4
- 7 T-grid (By Others)
- 8 Plastic Grommet
- 9 Ceiling Tile (By Others)
- 10 Power Cord
- 11 4" Canopy Power Feed
- 12 Cable Holder
- 13 Strain Relief Thread Nut
- 14 Aircraft Cable
- 15 2" Canopy

▶ NON POWER SUSPENSION

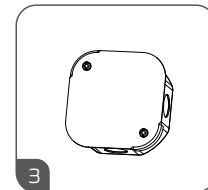
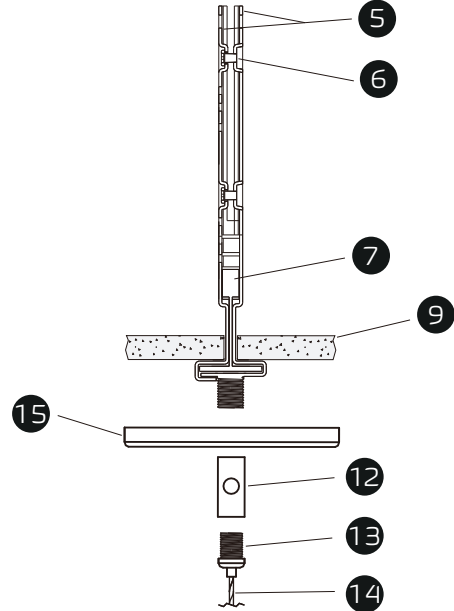

4" Octagon Junction Box

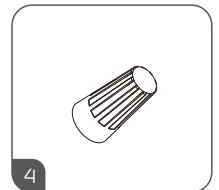

Wire Nut

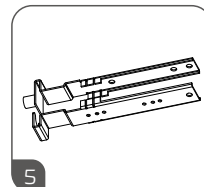

Assembled T-grid Clips

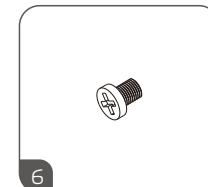

Screw 6#*4

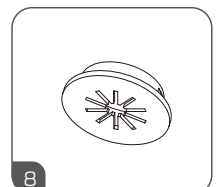

Plastic Grommet

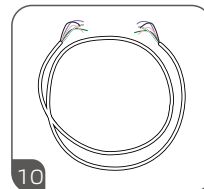

Power Cord

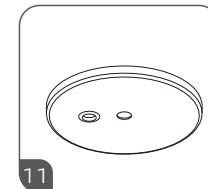

4" Canopy Power Feed

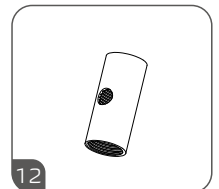

Cable Holder

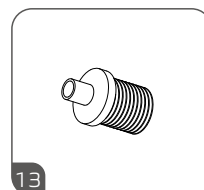

Strain Relief Thread Nut

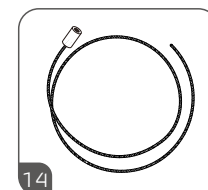

Aircraft Cable

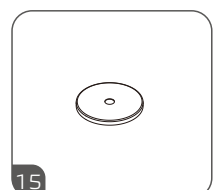

2" Canopy

WARNING:



RISK OF FIRE AND ELECTRICAL SHOCK. FIXTURE MUST BE INSTALLED BY A QUALIFIED ELECTRICIAN ONLY IN ACCORDANCE WITH NATIONAL, LOCAL BUILDING AND ELECTRICAL CODES. DISCONNECT POWER AT ELECTRICAL PANEL BEFORE SERVICING.



Architectural 1.3" LED Luminaire

Pendant

Independent Installation

! IMPORTANT

1. Read all instructions.
2. Install in accordance with national and local electrical code regulations.
3. This product is intended to be installed and serviced by a qualified, licensed electrician.
4. Do not install in wet locations. For dry and damp use only.
5. Turn off electrical power before installing or servicing fixture in any way.
6. To reduce the risk of fire and overheating, make sure all connections are tight.
7. Under no circumstances can the lighting fixture be covered with heat insulation gasket or similar materials.
8. The maximum connection of each input line is less than 40FT(1200CM) in 120AC, less than 80FT (2400CM) in 230AC, less than 100FT(3000CM) in 277AC.

! SHOCK HAZARD!



May result in serious injury or death. Turn power OFF at circuit breaker prior to installation or servicing.

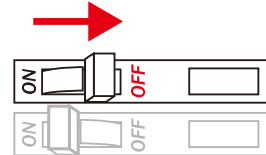

🔧 TOOLS REQUIRED

Tools:

1. Sharp Side Cutter
2. Electric Drill
3. Level
4. Measuring Tool
5. Wire Stripper / Knife
6. Philips Screwdrivers
7. Wire Cutters

🔌 Wiring

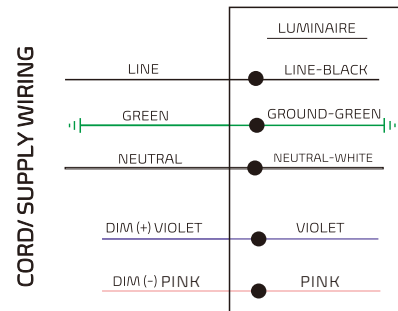

Step 1 Hang Luminaire

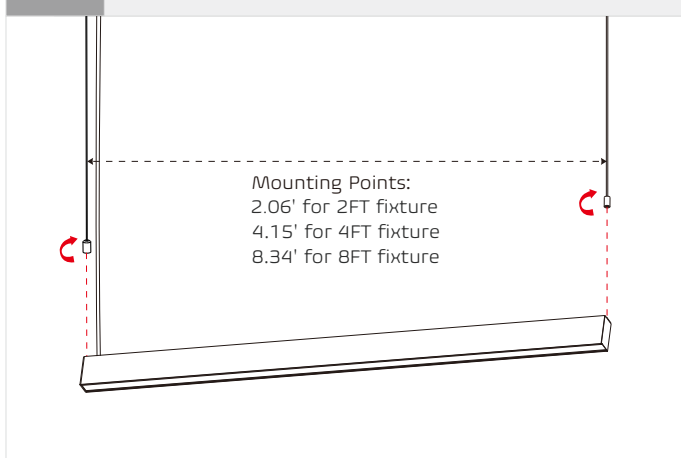

Mounting Points:
2.06' for 2FT fixture
4.15' for 4FT fixture
8.34' for 8FT fixture

Screw both bottom parts of aircraft cables clockwise and secure then on the top of housing making sure they hang the lights.

▲ Adjust the height of luminaire. Luminaire can be raised by pulling cable through the gripper and can be lowered by depressing the top cylinder on the gripper which pulls the luminaire down.

Step 2 Complete

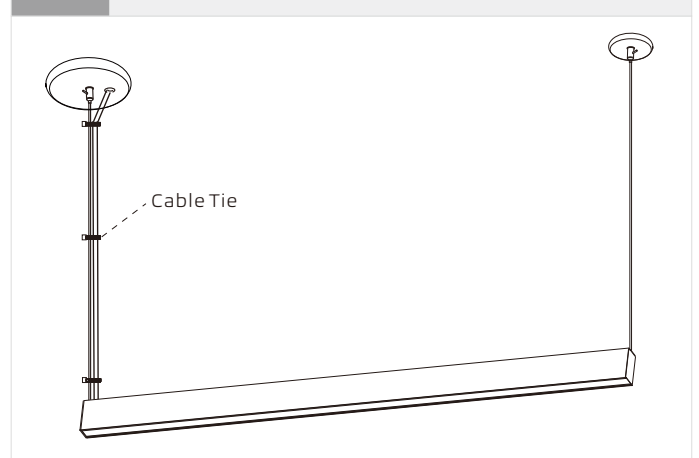

Use the cable tie to keep the electric wire going up along with the wire rope.



Joiner Options						Accessory
"—" Joiner	"L" Joiner	"T" Joiner	"+" Joiner	"Y" Joiner	"V" Joiner	Silicone Seal

⚠ Noted: Silicone Seal is used to seal seams that may appear at both ends of luminaires when multiple connections.

⚠ It needs 2 inputs if using joiner "T", "+" and "Y".

Pre-installation Disassemble luminaires as shown below

Start of run (SoR): Remove the end cap without power code, and take the LED module out.

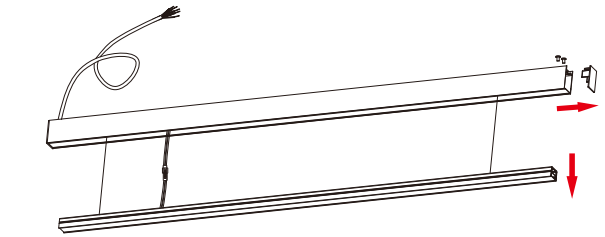

Middle of run (MoR): Remove both end caps, and take the LED module out.



End of run (EoR): Remove the end cap with power code, and take the LED module out.





A. Line Connection

Step 1 Install joiners

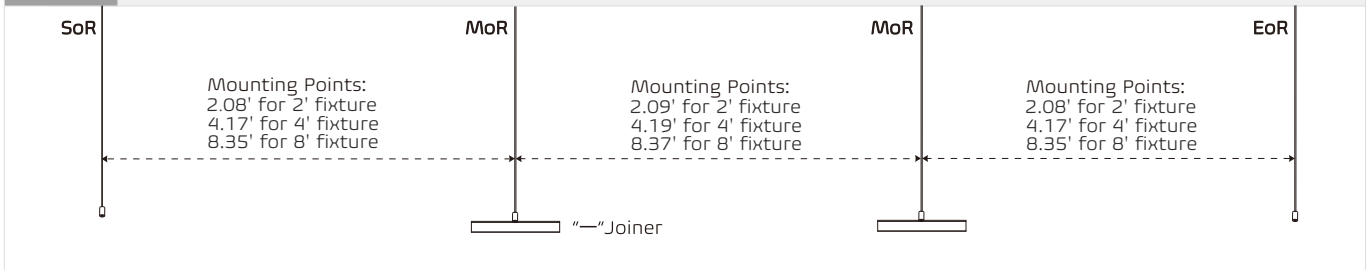

Screw the joiner "—" to the MoR aircraft cable in turn.

Step 2 Hang luminaire and wiring - SoR

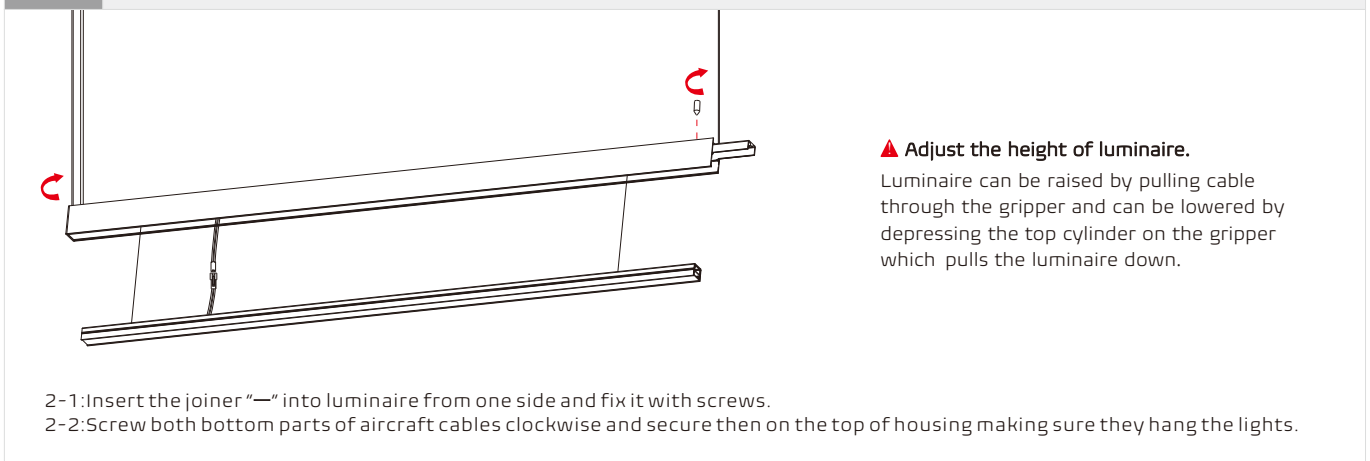

Step 3 Repeat Hang and join steps – MoR to EoR

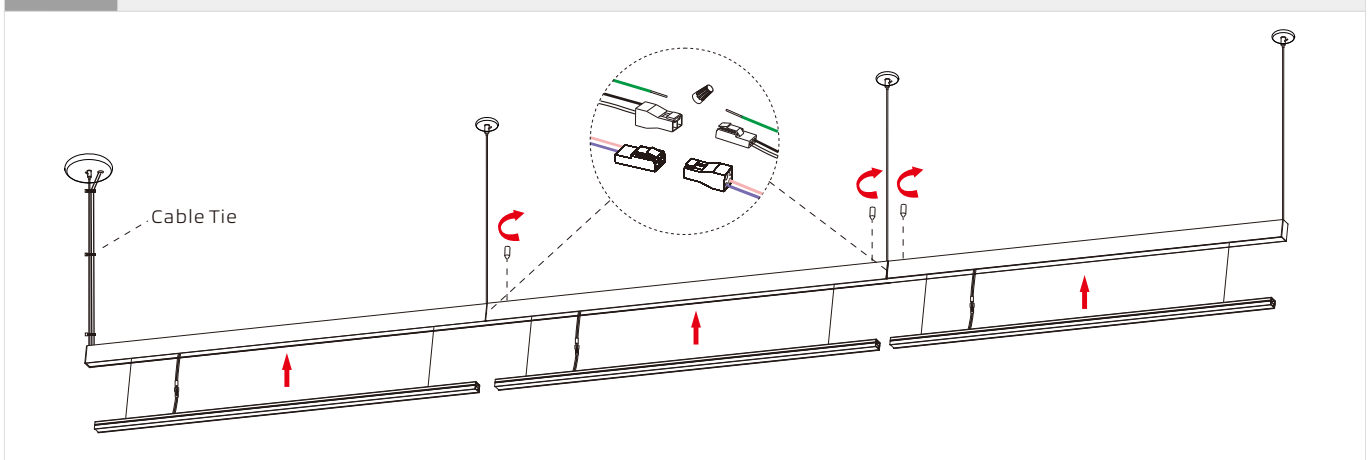



Step 4 Complete

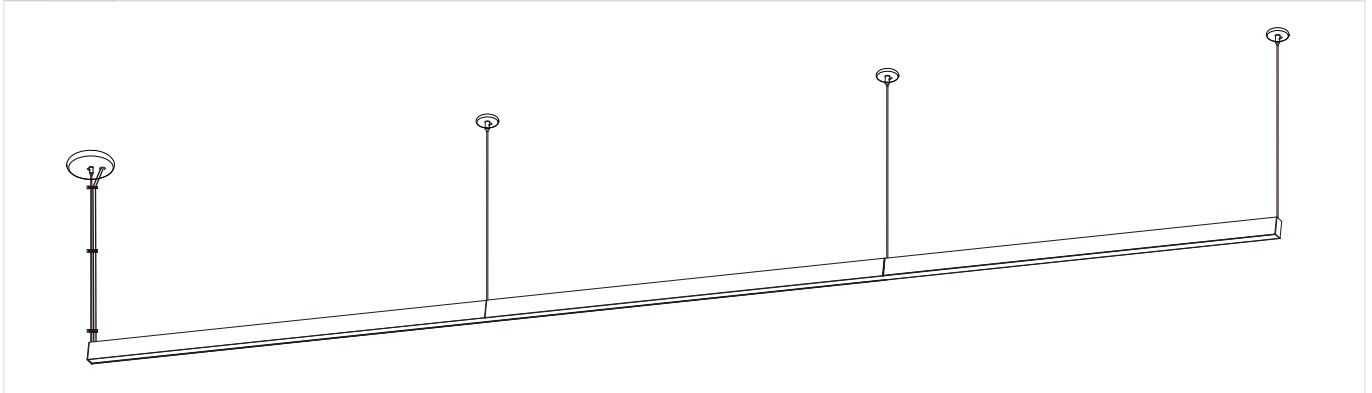

42' Diffuser Lens Roll

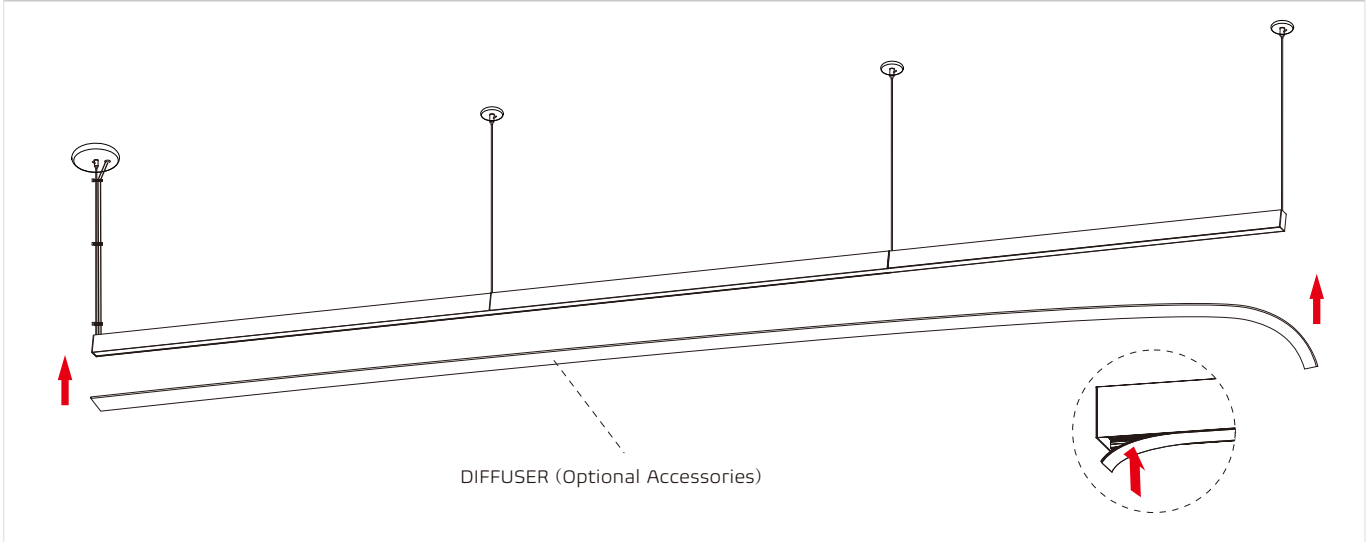



B. L Shape Connection

- ▲ For "T", "+", "Y" shape or other geometric shapes, all subject to the "L" shape installation
- ▲ It needs 2 inputs if using joiner "T", "+" and "Y".

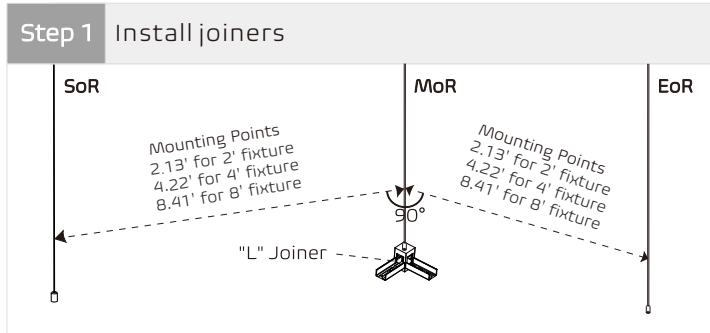

Screw the joiner "L" to the MoR aircraft cable in turn.

