



# SOSEN LED Driver, Your Smart Choice

## Specifications

### SS-320VP Series LED Driver

Model: SS-320VP-XX

Description: 320W LED Driver

Rev.: V07

Release Date: 2022-01-18

# SS-320VP Series LED Driver

**SOSEN**  
LED DRIVER



**LED DRIVER**

**VP Series**



## Features:

- ▣ Efficiency up to 94%
- ▣ Dimming: DALI-2, 0-10V,PWM,Resistor,Timing
- ▣ Dim-to-Off
- ▣ Surge Protection: CM: 10kV, DM: 6kV
- ▣ AUX Power : 12V/0.2A
- ▣ Constant Lumen, Life Warning
- ▣ Optional Standby(STB) Function
- ▣ External NTC to Protect LED Module
- ▣ Standby Power <0.5W
- ▣ IP67
- ▣ Communication Function With PC
- ▣ Type HL, suitable for hazardous locations
- ▣ Protections: SCP/OTP/OVP
- ▣ Warranty: 8 years



## Description:

SS-320VP series are 320W constant current LED Driver with wide O/P voltage range and adjustable O/P current by program. LED luminaries manufactures can easily design luminaries and reduce cost.

### Application:

High bay lighting, Stadium lighting, Square lighting, Plant lighting, Fish lighting

## Model List:

Model	AC Input Range	Max. Pout	Vout Range	Full Power Working Voltage	Iout	Iout (DALI-2)	THD (Typ.)	PF (Typ.)	Eff. (Typ.)	Max.Tc
SS-320VP-56*	90-305Vac	320W	22-56V	38-56V	1.05-8.4A	4.66-8.4A	10%	0.95	94%	90°C
SS-320VP-68*	90-305Vac	320W	34-68V	48-68V	0.7-6.7A	3.72-6.7A	10%	0.95	93.5%	90°C
SS-320VP-228*	90-305Vac	320W	114-228V	182-228V	0.35-1.75A	0.97-1.75A	10%	0.95	93.5%	90°C
SS-320VP-428*	90-305Vac	320W	214-428V	304-428V	0.1-1.05A	0.58-1.05A	10%	0.95	94%	90°C

Note:

1.Default Tested: at 220Vac, full load, Ta 25°C.

2.The performance of the LED Driver can be guaranteed within the full power Vo range.The voltage lower than full power Vo range, it is need to test the performance with the LED module.

# SS-320VP Series LED Driver

## “\*” Means Additional Function

“*”	DALI (suffix:D)	AUX 12V (suffix:H)	NTC (suffix:N)	Timing	0-10V/PWM Dim /Resistor (suffix:B)	Remark
BH		✓		✓	✓	
BHN		✓	✓	✓	✓	
DH	✓	✓				
DHN	✓	✓	✓			

## Input Characteristics:

Parameter	Min.	Typ.	Max.	Remark
Rated AC Input Range	100Vac		277Vac	
AC Input Range	90 Vac		305Vac	
Input Frequency Range	47Hz	50/60Hz	63Hz	
Max Input Current			4A	100Vac, full load
Max Input Power			380W	100Vac, full load
Max Inrush Current(120Vac)			55A	Cold Start
Max Inrush Current(220Vac)			110A	Cold Start
Max Inrush Current(277Vac)			140A	Cold Start
Standby Power			0.5W	220Vac/50Hz, Dim to off or Enable STB
Power Factor	0.95	0.97		220Vac/50Hz, full load
	0.90			277Vac, 70-100% load
THD		8%	10%	220Vac/50Hz, full load
			20%	277Vac, 70-100% load

# SS-320VP Series LED Driver

## O/P Characteristics(SS-320VP-56\*):

Parameter	Min.	Typ.	Max.	Remark
O/P Voltage Range	22V		56V	Power Derated @22-38V
Rated O/P Voltage	38V		56V	$P_o=V_o \cdot I_o=320W$ , full load
Rated O/P Current	5.7A		8.4A	5.7A for 56V,8.4A for 38V
Adj. O/P Current (AOC)Range	1.05A		8.4A	By Programming
	4.66A		8.4A	For DALI-2
No Load Voltage			60V	
Efficiency @120Vac	89.5%	91.5%		O/P 48V/6.7A
Efficiency @220Vac	91.5%	93.5%		O/P 48V/6.7A
Efficiency @277Vac	92.0%	94.0%		O/P 48V/6.7A
O/P Current Tolerance	-5%		+5%	
O/P Current Ripple(PK-AV)		5%	10%	Full load
Start-up Current Overshoot			10%	Full load
Start-up Time			0.5S	120Vac, Full load
			0.5S	220Vac, Full load
			0.7S	230Vac,For DALI-2
Line Regulation	-2%		+2%	Full load
Load Regulation	-2%		+2%	
Temperature Coefficient	-0.03%/°C		+0.03%/°C	Tc:0°C~90°C
OTP	90°C	100°C	110°C	>Tc typ., Current Derating <Tc min., Operates Recovery
Short Circuit Protection			10W	Driver will not be damaged, Hiccup mode
			0.5W	Driver will not be damaged, Shut down for DALI-2

# SS-320VP Series LED Driver

## O/P Characteristics(SS-320VP-68\*):

Parameter	Min.	Typ.	Max.	Remark
O/P Voltage Range	34V		68V	Power Derated @34V-48V
Rated O/P Voltage	48V		68V	$P_o = V_o \cdot I_o = 320W$ , full load
Rated O/P Current	4.7A		6.7A	4.7A for 68V, 6.7A for 48V
Adj. O/P Current (AOC) Range	0.7A		6.7A	By Programming
	3.72A		6.7A	For DALI-2
No Load Voltage			75V	
Efficiency @120Vac	89.5%	91.5%		O/P 58V/5.5A
Efficiency @220Vac	91.5%	93.5%		O/P 58V/5.5A
Efficiency @277Vac	91.5%	93.5%		O/P 58V/5.5A
O/P Current Tolerance	-5%		+5%	
O/P Current Ripple(PK-AV)		5%	10%	Full load
Start-up Current Overshoot			10%	Full load
Start-up Time			0.5S	120Vac, Full load
			0.5S	220Vac, Full load
			0.7S	230Vac, For DALI-2
Line Regulation	-2%		+2%	Full load
Load Regulation	-2%		+2%	
Temperature Coefficient	-0.03%/°C		+0.03%/°C	Tc:0°C~90°C
OTP	90°C	100°C	110°C	>Tc typ., Current Derating <Tc min., Operates Recovery
Short Circuit Protection			10W	Driver will not be damaged, Hiccup mode
			0.5W	Driver will not be damaged, Shut down for DALI-2

# SS-320VP Series LED Driver

## O/P Characteristics(SS-320VP-228\*):

Parameter	Min.	Typ.	Max.	Remark
O/P Voltage Range	114V		228V	Power Derated @114V-182V
Rated O/P Voltage	182V		228V	$P_o = V_o * I_o = 320W$ , full load
Rated O/P Current	1.4A		1.75A	1.75A for 182V, 1.4A for 228V
Adj. O/P Current (AOC) Range	0.35A		1.75A	By Programming
	0.97A		1.75A	For DALI-2
No Load Voltage			250V	
Efficiency @120Vac	89.5%	91.5%		O/P 228V/1.4A
Efficiency @220Vac	91.5%	93.5%		O/P 228V/1.4A
Efficiency @277Vac	91.5%	93.5%		O/P 228V/1.4A
O/P Current Tolerance	-5%		+5%	
O/P Current Ripple(PK-AV)		5%	10%	Full load
Start-up Current Overshoot			10%	Full load
Start-up Time			0.5S	120Vac, Full load
			0.5S	220Vac, Full load
			0.7S	230Vac, For DALI-2
Line Regulation	-2%		+2%	Full load
Load Regulation	-2%		+2%	
Temperature Coefficient	-0.03%/°C		+0.03%/°C	Tc:0°C~90°C
OTP	90°C	100°C	110°C	>Tc typ., Current Derating <Tc min., Operates Recovery
Short Circuit Protection			10W	Driver will not be damaged, Hiccup mode
			0.5W	Driver will not be damaged, Shut down for DALI-2

# SS-320VP Series LED Driver

## O/P Characteristics(SS-320VP-428\*):

Parameter	Min.	Typ.	Max.	Remark
O/P Voltage Range	214V		428V	Power Derated @214V-304V
Rated O/P Voltage	304V		428V	$P_o = V_o \cdot I_o = 320W$ , full load
Rated O/P Current	0.75A		1.05A	1.05A for 304V, 0.75A for 428V
Adj. O/P Current (AOC) Range	0.1A		1.05A	By Programming
	0.58A		1.05A	For DALI-2
No Load Voltage			450V	
Efficiency @120Vac	89.5%	91.5%		O/P 428V/0.75A
Efficiency @220Vac	92.0%	94.0%		O/P 428V/0.75A
Efficiency @277Vac	92.0%	94.0%		O/P 428V/0.75A
O/P Current Tolerance	-5%		+5%	
O/P Current Ripple(PK-AV)		5%	10%	Full load
Start-up Current Overshoot			10%	Full load
Start-up Time			0.5S	120Vac, Full load
			0.5S	220Vac, Full load
			0.7S	230Vac, For DALI-2
Line Regulation	-2%		+2%	Full load
Load Regulation	-2%		+2%	
Temperature Coefficient	-0.03%/°C		+0.03%/°C	Tc: 0°C~90°C
OTP	90°C	100°C	110°C	>Tc typ., Current Derating <Tc min., Operates Recovery
Short Circuit Protection			10W	Driver will not be damaged, Hiccup mode
			0.5W	Driver will not be damaged, Shut down for DALI-2

# SS-320VP Series LED Driver

## Other Characteristics:

Parameter		Min.	Typ.	Max.	Remark
Aux Power	O/P Voltage	10.8V	13V	13.8V	
	O/P Current	0mA		200mA	
0-10V Dimming (Optional)	Dim Vcc	0V		12V	Negative dimming by programming
	Dim Range	10%Ioset		100%Ioset	DIM + source current 110uA.
	Rec.Dim Range	0V		10V	Dimming prohibits reverse connection.
PWM Dimming (Optional)	PWM High	9.8V		10.2V	Negative dimming by programming
	PWM Low	0V		0.3V	DIM + source current 110uA.
	Frequency	1KHz		2KHz	Dimming prohibits reverse connection.
	PWM Duty	0%		100%	
Resistor Dimming (Optional)	Resistance	0K		100K	Negative dimming by programming
	Dim Range	10%		100%	DIM + source current 110uA.
Dim to Off (Optional)	Dim off	7%	8%	9%	By DC voltage, PWM, resistance dimming ratio
	Dim on	8%	9%	10%	By DC voltage, PWM, resistance dimming ratio
DALI Dimming Level		1-170(10%)		254(100%)	Logarithmic dimming curve
Timing Curve(Optional)		By programming			DALI models does not support this function
DALI Dimming(Optional)		Meet DALI-2			
Constant Lumen(Optional)		By programming			DALI models does not support this function
Life Warning(Optional)		By programming			DALI models does not support this function
Life Time(Tc≤75°C)		71,000 hours			80% Load
MTBF		198,200 hours			220Vac,full load, Ta=25°C (MIL-HDBK-217F)
IP Grade		IP67			
Tc		90°C			
Warranty		8 years			Tc : 75°C
Net Weight		1980g			
Dimension		252mm*89.5mm*44.5mm 9.92in*3.52in*1.75in			L x W x H

NOTE: 1,All the parameters above are tested Ta 25°C and LED load, unless specified.

2. When using resistor dimming (parallel connection of dimming wires), if the number of parallels is: N, the dimming resistor should be realized 0-100% dimming range, resistance value: 91KΩ/N.



# SS-320VP Series LED Driver

## Environmental Requirements

Parameter	Min.	Typ.	Max.	Remark
Operating Temperature(Tcase)	-40°C	25°C	+90°C	
Storage Temperature	-40°C	25°C	+90°C	
Operation Humidity	10%RH		90%RH	
Storage Humidity	5%RH		95%RH	
Altitude	-65m		4000m	

## Safety and EMI/EMS Standards

Certification	Standard	Status	Remark
UL/cUL	UL8750	✓	
ENEC	EN 61347-1:2015 EN 61347-2-13:2014 EN 61347-2-13:2014/A1:2017	✓	
RCM	AS/NZS61347.2.13	✓	
BIS	IS15885:2012 Part 2 Sec 13		
CCC	GB 19510.14-2009	✓	
CE	EN 61347-2-13:2014 EN61347-1:2008+A1:2011+A2:2013	✓	

EMI/EMS	Criterion	Remark
Conduction Emission	EN55015:2013+A1:2015 FCC Part 15 Subpart B; ANSI C63.4:2014	Class B
Radiation Emission	EN55015:2013+A1:2015 FCC Part 15 Subpart B; ANSI C63.4:2014	Class B
Harmonic Current Emissions	IEC/EN 61000-3-2	Class C
Surge	IEC/EN 61000-4-5	DM: 6kV,CM: 10kV,Criterion B
Ring Wave	IEC/EN 61000-4-12	DM: 6kV,CM: 6kV,Criterion B

# SS-320VP Series LED Driver

## Safety Test Items:

Safety Test Items	Technical Indicators			Remark
	UL Insulation Requirements	ENEC Insulation Requirements	CCC Insulation Requirements	
Insulation Requirements	UL Insulation Requirements	ENEC Insulation Requirements	CCC Insulation Requirements	
Input-Output	1600Vac	3000Vac	3750Vac	Reinforced insulation
Input-Case	1600Vac	1500Vac	1875Vac	Basic insulation
Input-Dim	1600Vac	3000Vac	3750Vac	Reinforced insulation
Output-Dim	1600Vac	1000Vac	1000Vac	Basic insulation
Output-Case	1600Vac	1000Vac	1000Vac	Basic insulation
Dim-Case	500Vac	500Vac	500Vac	Basic insulation
Insulation Resistance	≥10MΩ			Input-Output, Test voltage: 500Vdc
Ground Resistance	≤0.1Ω			25A/1min
Leakage Current	≤0.75mA			277Vac

### NOTE:

1. SOSEN warrants the LED Driver itself complies with EMC standard. However, LED Driver's EMC should be re-checked when integrated into lighting systems due to unexpected interference as component.
2. Please short (ACL and ACN), (V+ and V- and NTC+ and NTC-), (Dim+ and Dim - and Vaux+ and Vaux- and STB) when Hi-pot test.
3. The CCC withstand voltage test needs to disconnect the built-in lightning protection tube. According to the IEC 60598-1:14 standard section 10.2, the "built-in lightning protection tube" can be marked on the nameplate to disconnect the discharge tube on testing.

## Performance Curves:

### Input inrush Current

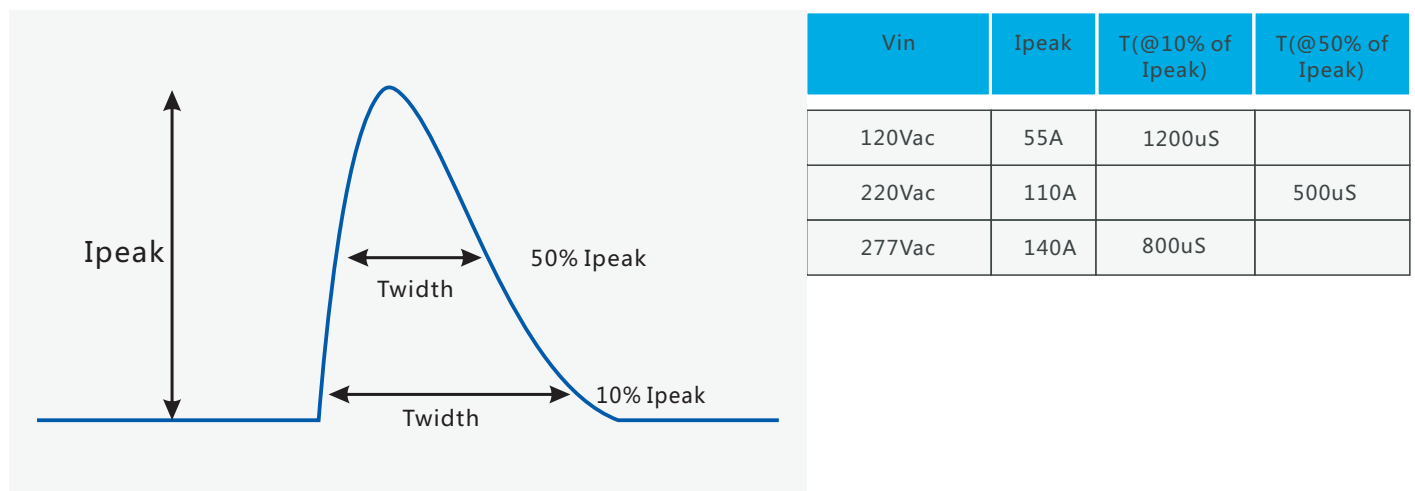

# SS-320VP Series LED Driver

## Performance Curves:

O/P Voltage Vs. O/P Current(DIM/AOC Window)

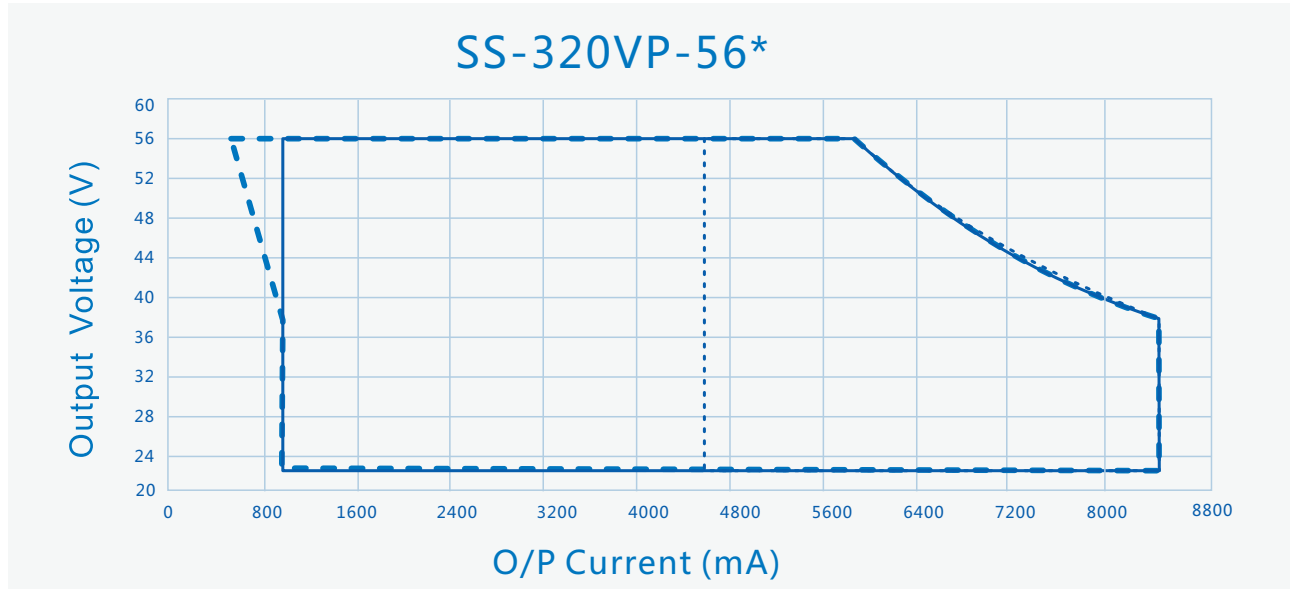

----- Dimming Window

———— AOC Window

..... AOC Window For DALI-2

O/P Voltage Vs. O/P Current(DIM/AOC Window)

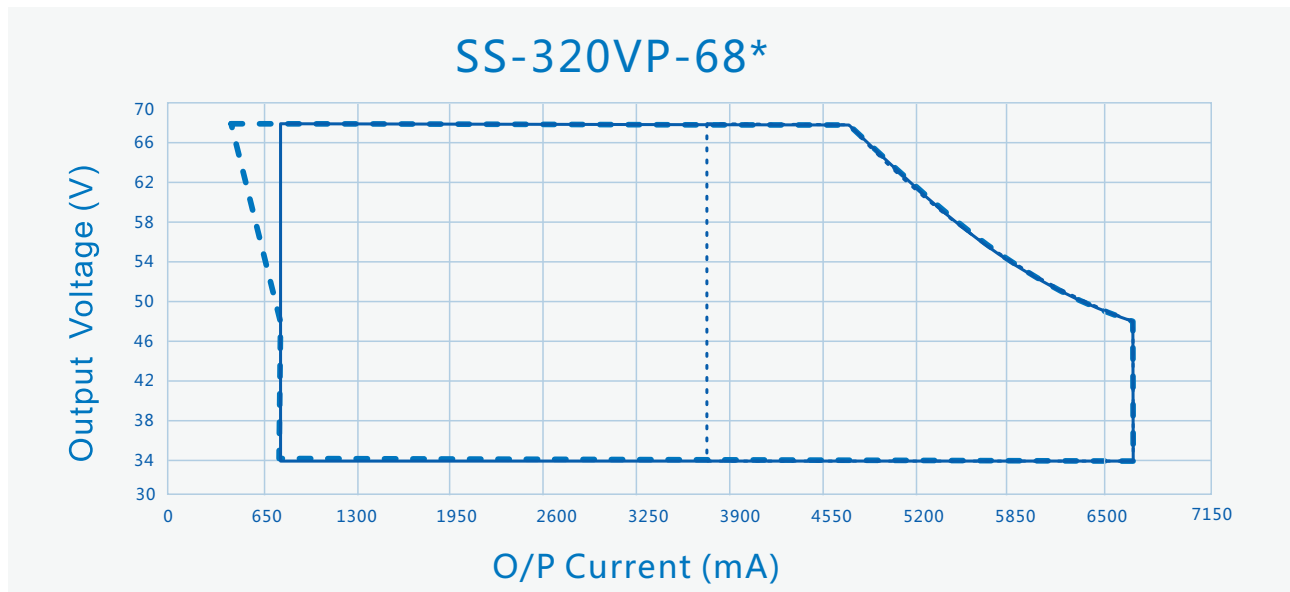

----- Dimming Window

———— AOC Window

..... AOC Window For DALI-2

# SS-320VP Series LED Driver

## Performance Curves:

O/P Voltage Vs. O/P Current(DIM/AOC Window)

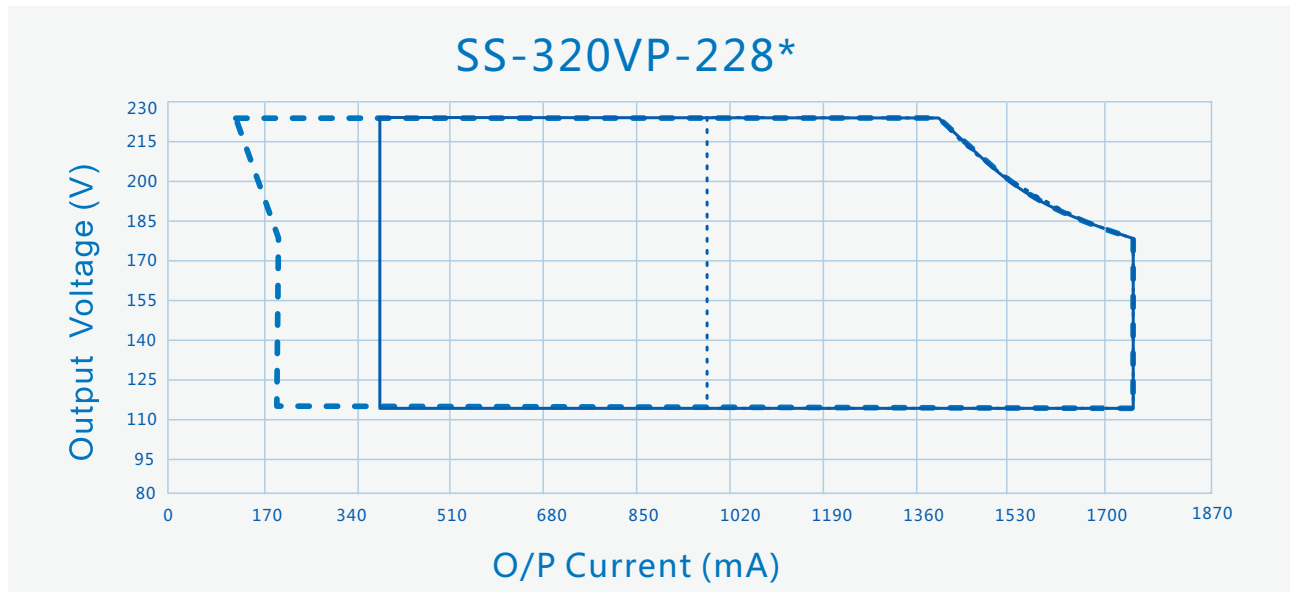

----- Dimming Window

————— AOC Window

..... AOC Window For DALI-2

O/P Voltage Vs. O/P Current(DIM/AOC Window)

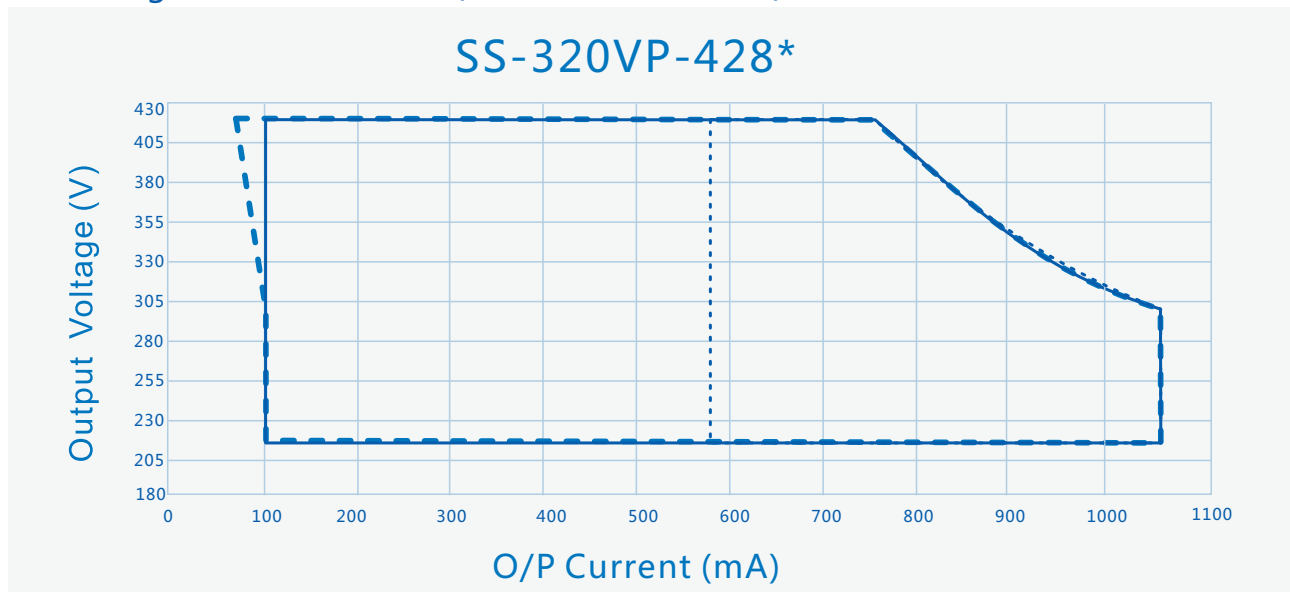

----- Dimming Window

————— AOC Window

..... AOC Window For DALI-2

# SS-320VP Series LED Driver

## Performance Curves:

Efficiency Vs. O/P Voltage ( $V_{in}=120Vac$ )

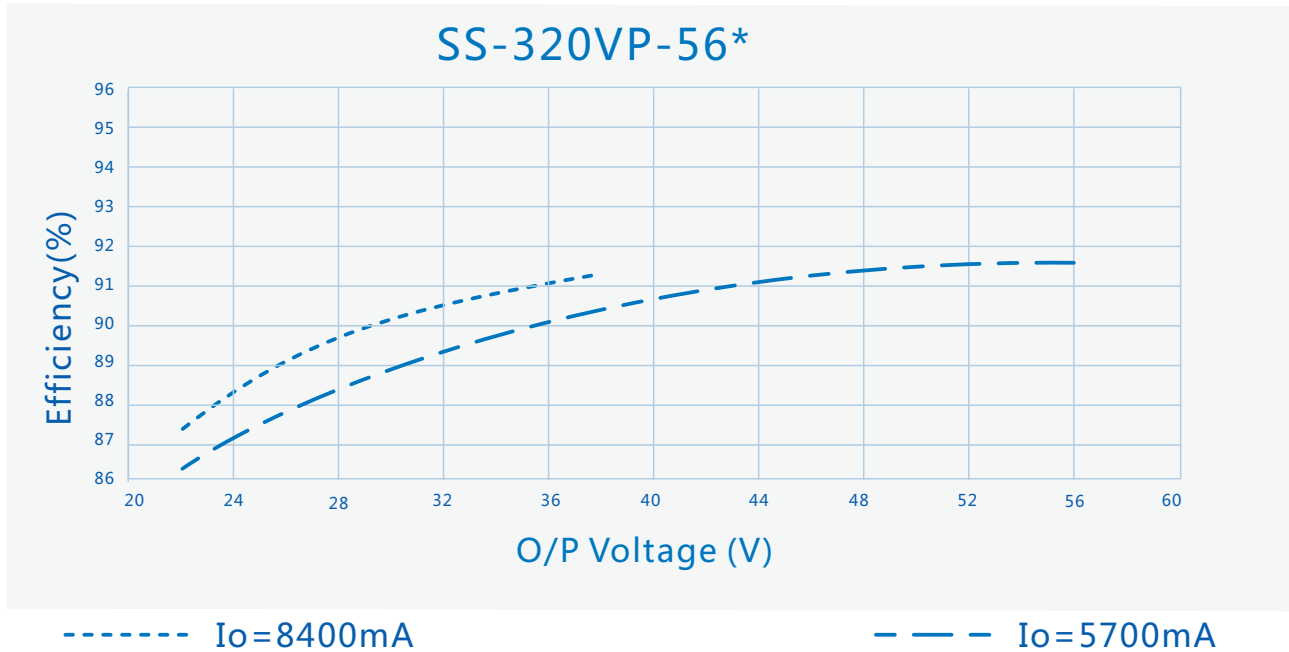

Efficiency Vs. O/P Voltage ( $V_{in}=220Vac$ )

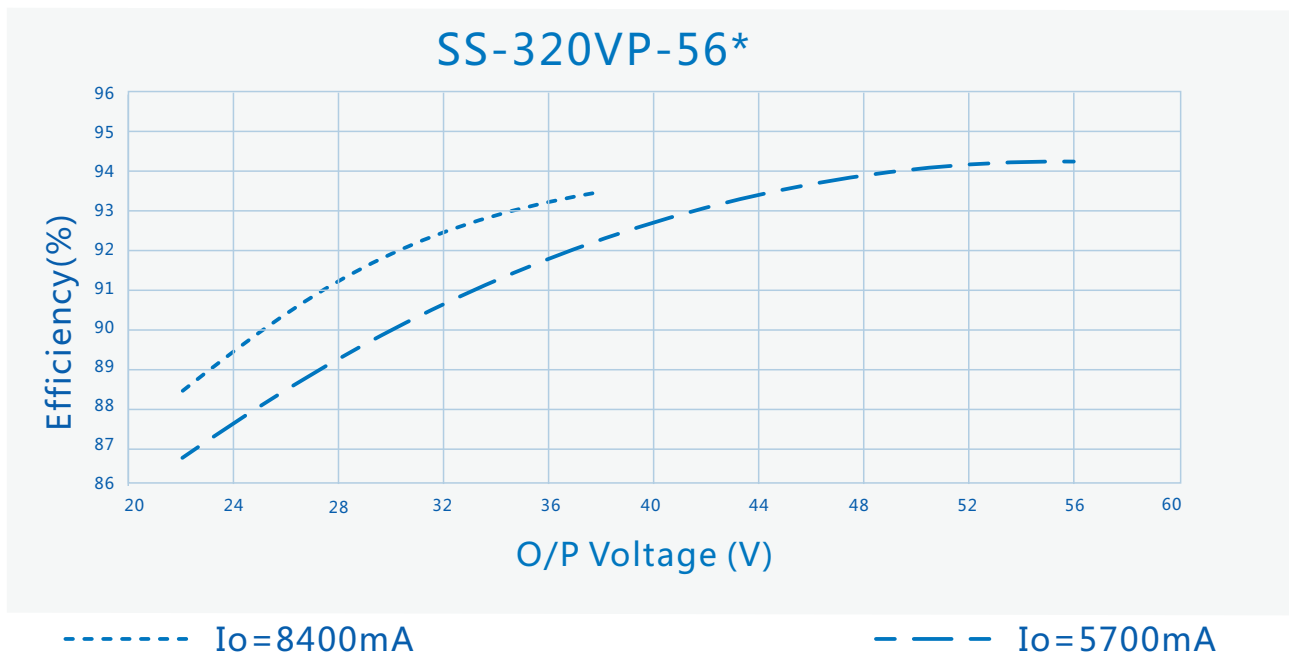

# SS-320VP Series LED Driver

## Performance Curves:

Efficiency Vs. O/P Voltage ( $V_{in}=277V_{ac}$ )

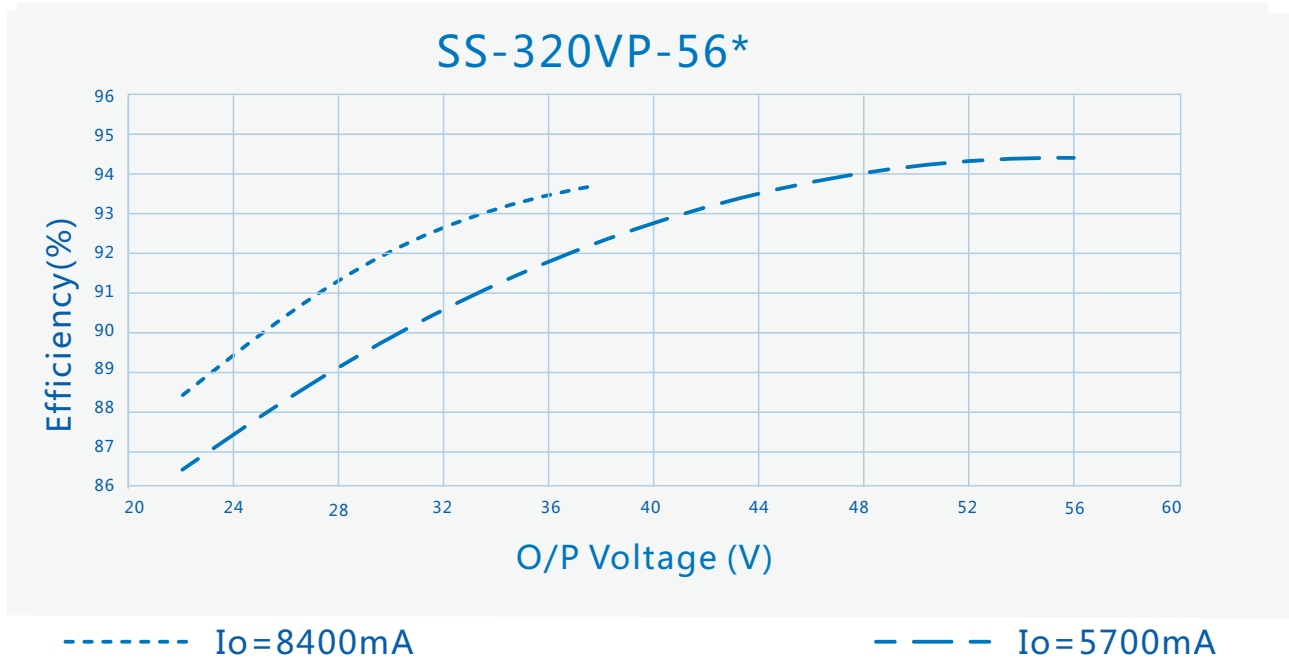

Efficiency Vs. O/P Voltage ( $V_{in}=120V_{ac}$ )

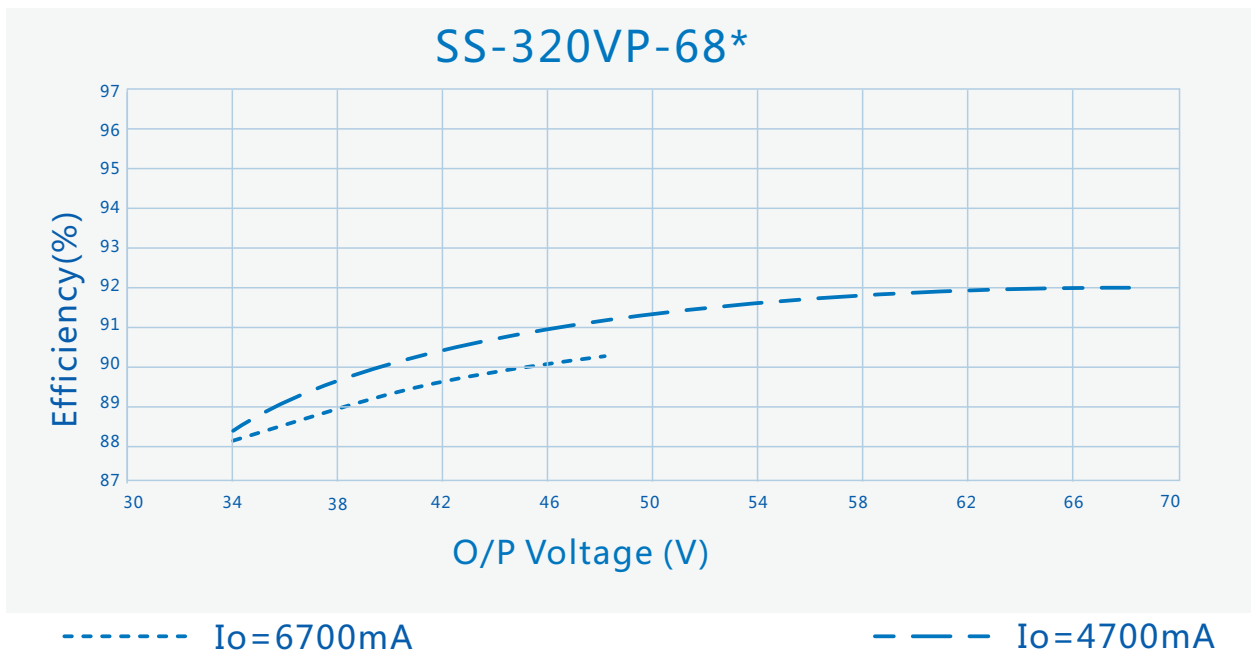

# SS-320VP Series LED Driver

## Performance Curves:

Efficiency Vs. O/P Voltage ( $V_{in}=220V_{ac}$ )

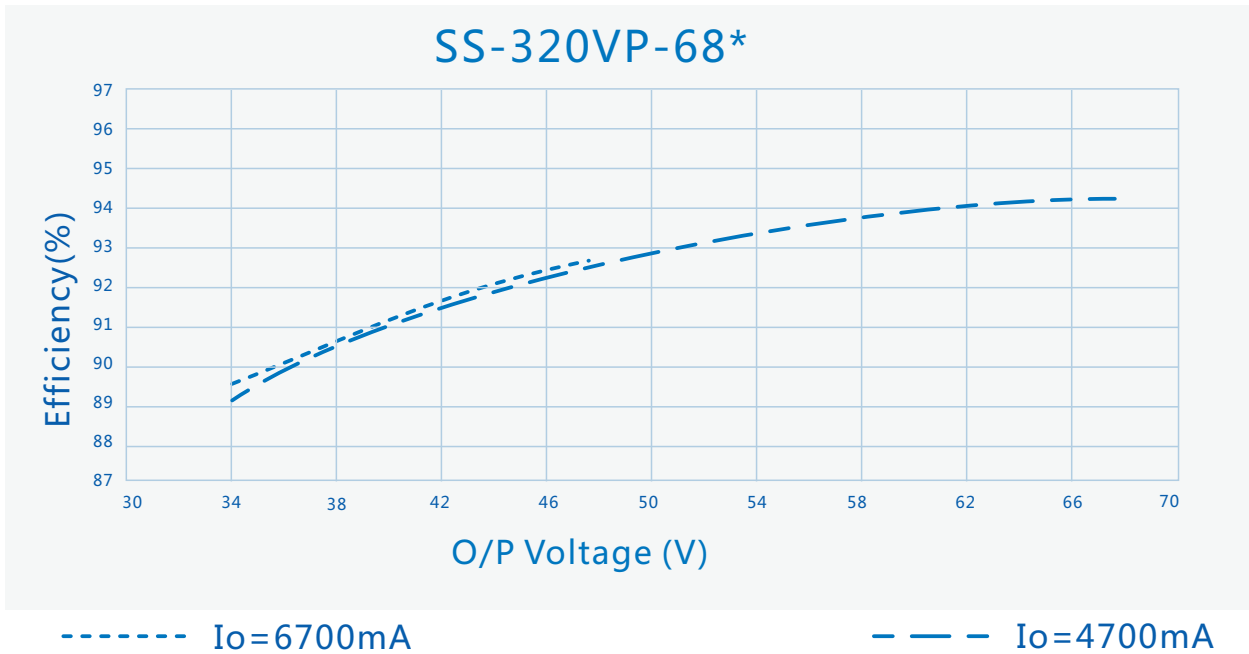

Efficiency Vs. O/P Voltage ( $V_{in}=277V_{ac}$ )

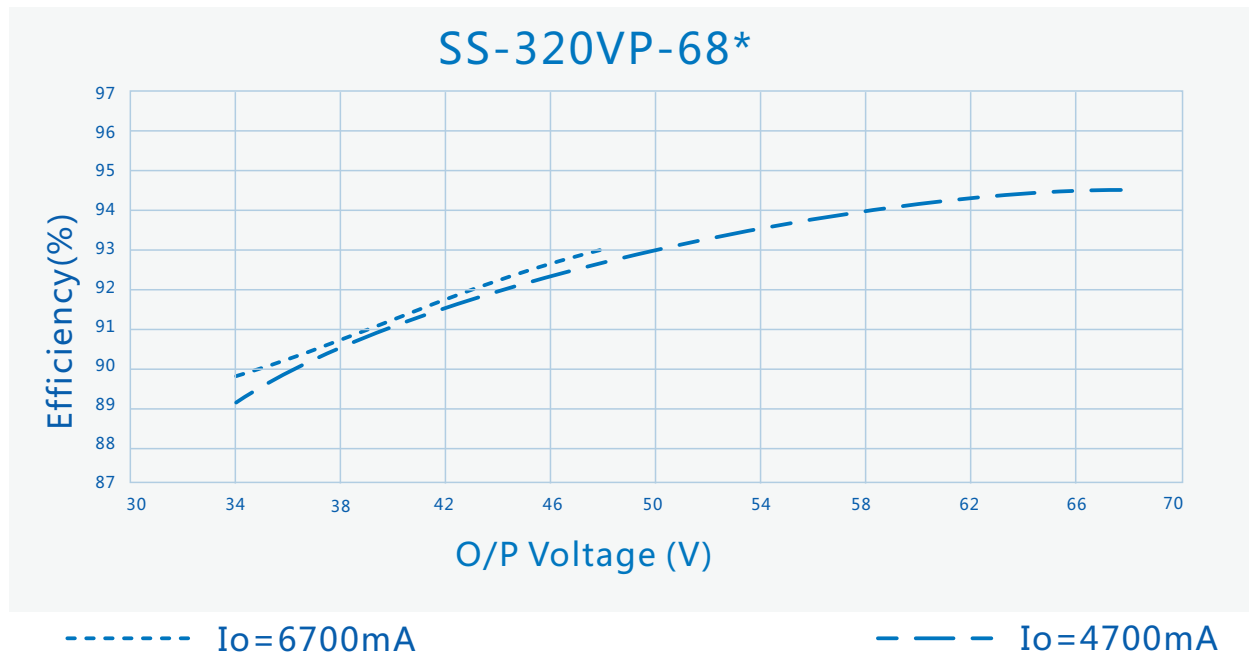

# SS-320VP Series LED Driver

## Performance Curves:

Efficiency Vs. O/P Voltage ( $V_{in}=120Vac$ )

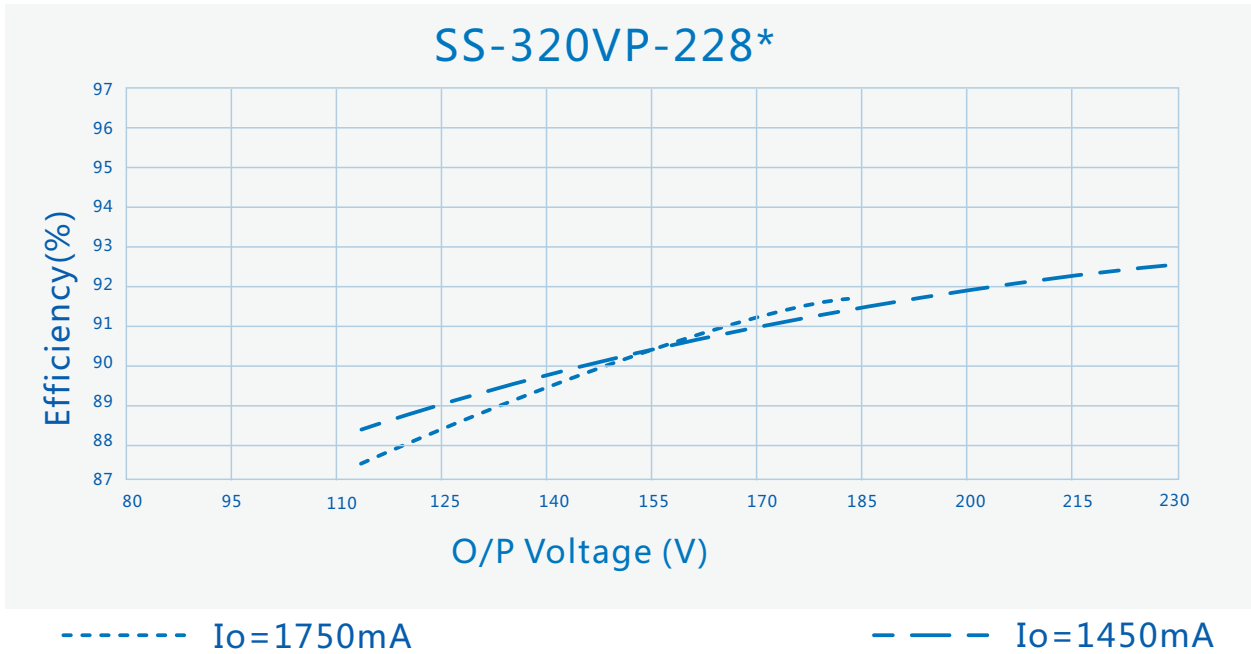

Efficiency Vs. O/P Voltage ( $V_{in}=220Vac$ )

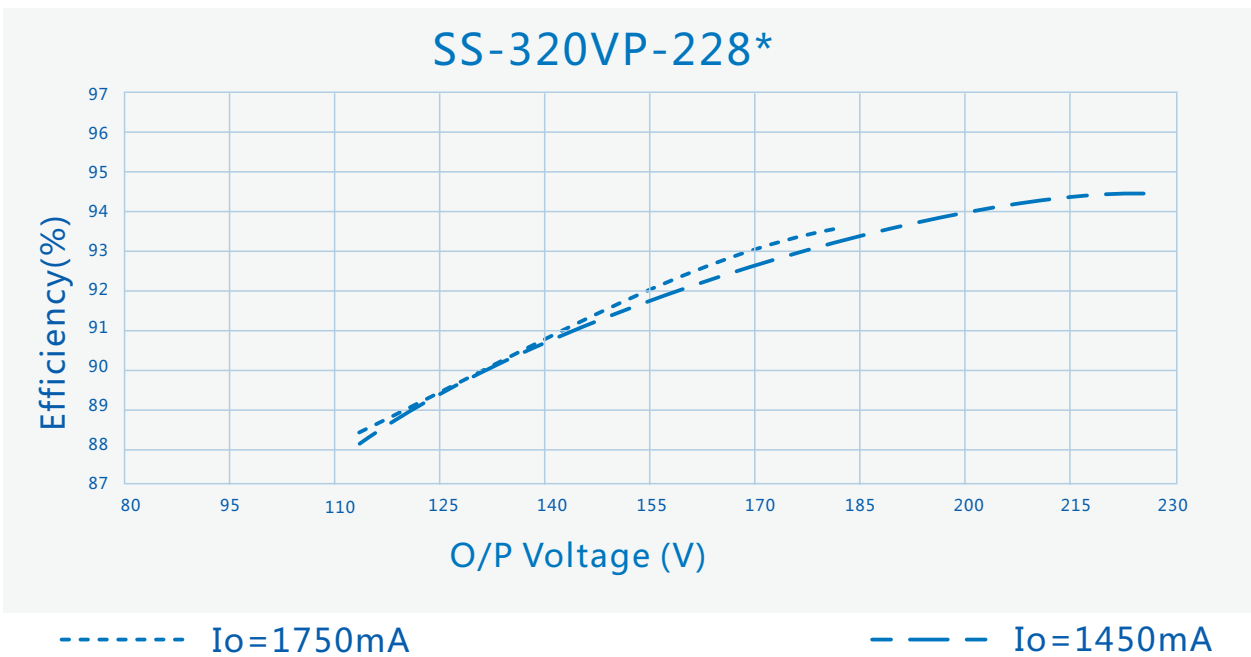



# SS-320VP Series LED Driver

## Performance Curves:

Efficiency Vs. O/P Voltage (Vin=277Vac)

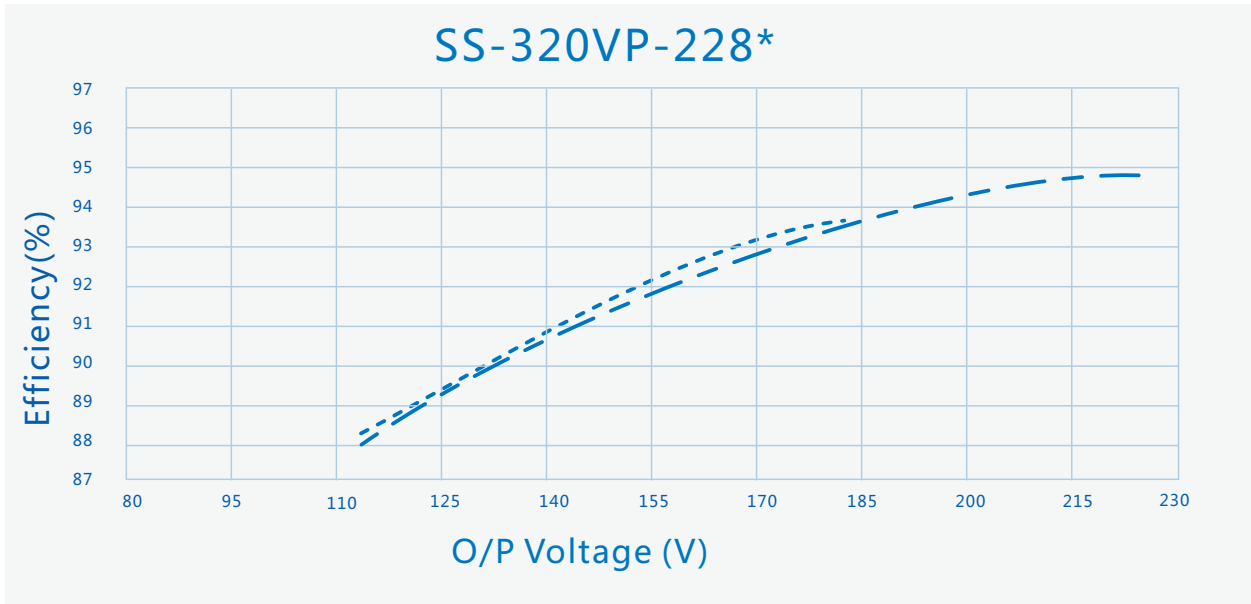

----- Io=1750mA

- . - . Io=1450mA

Efficiency Vs. O/P Voltage (Vin=120Vac)

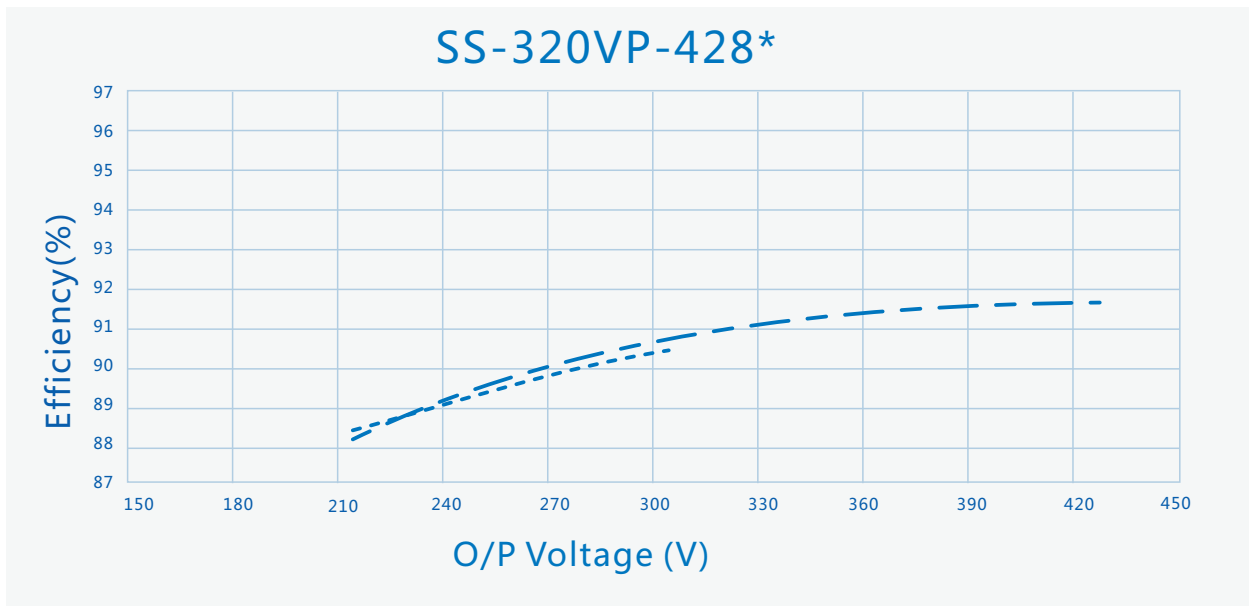

----- Io=1050mA

- . - . Io=750mA

# SS-320VP Series LED Driver

## Performance Curves:

Efficiency Vs. O/P Voltage ( $V_{in}=220V_{ac}$ )

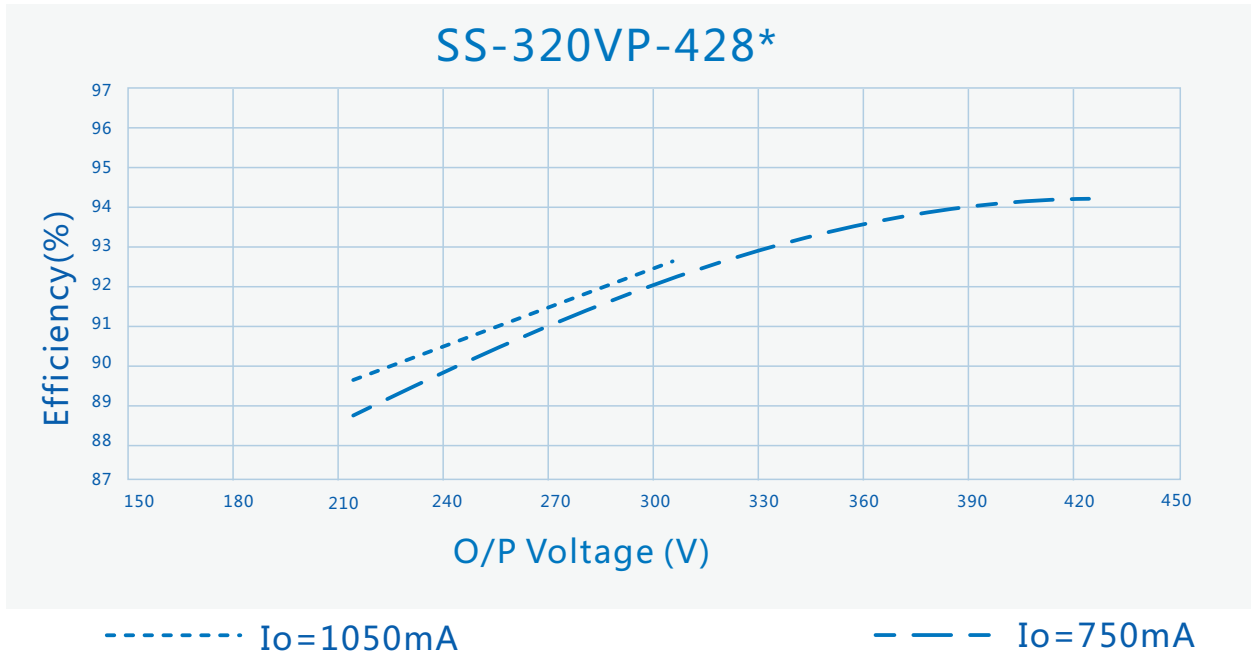

Efficiency Vs. O/P Voltage ( $V_{in}=277V_{ac}$ )

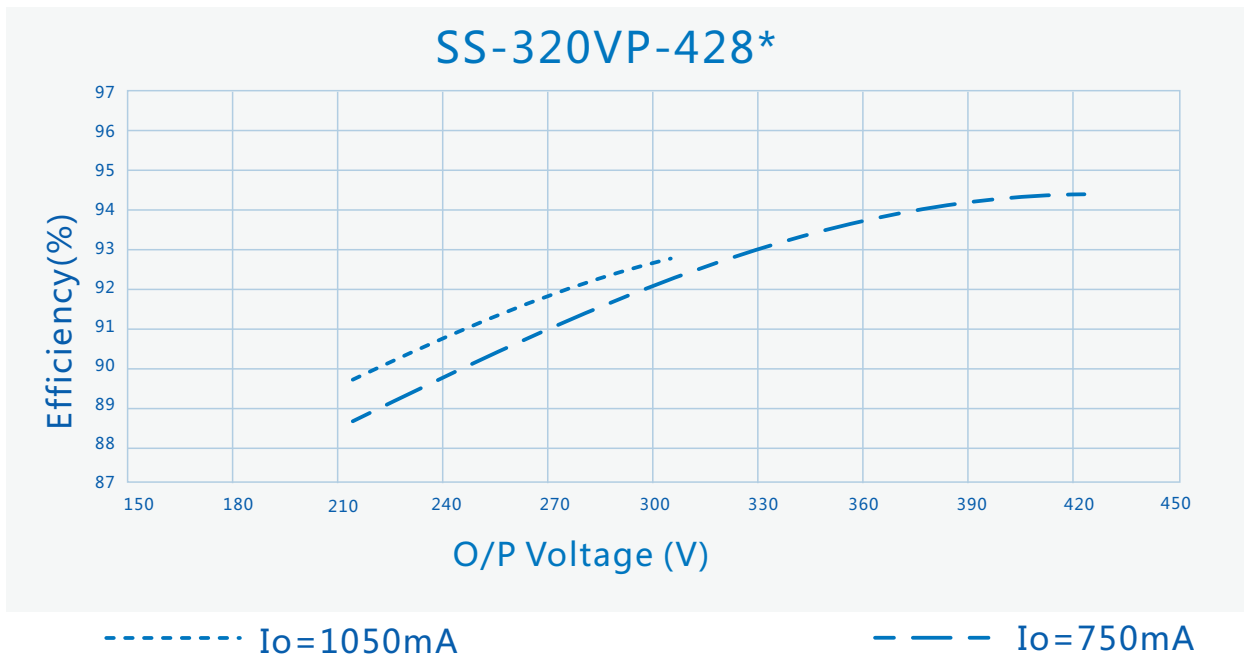

# SS-320VP Series LED Driver

## Performance Curves:

### Power Factor Vs. O/P Power

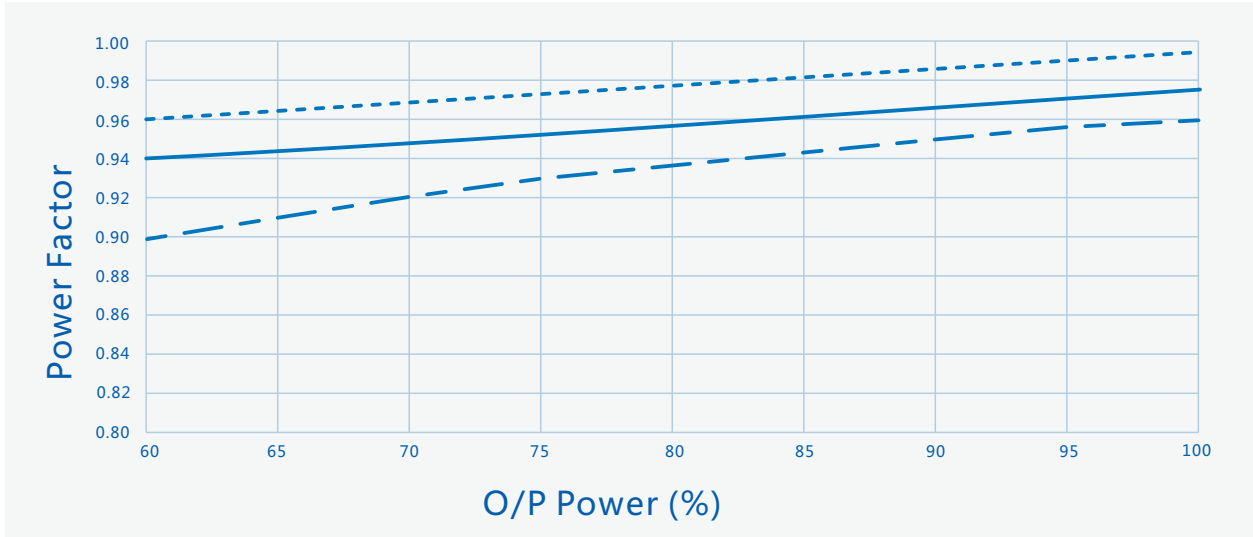

----- Vin=120Vac      ——— Vin=220Vac      - - - Vin=277Vac

### THD Vs. O/P Power

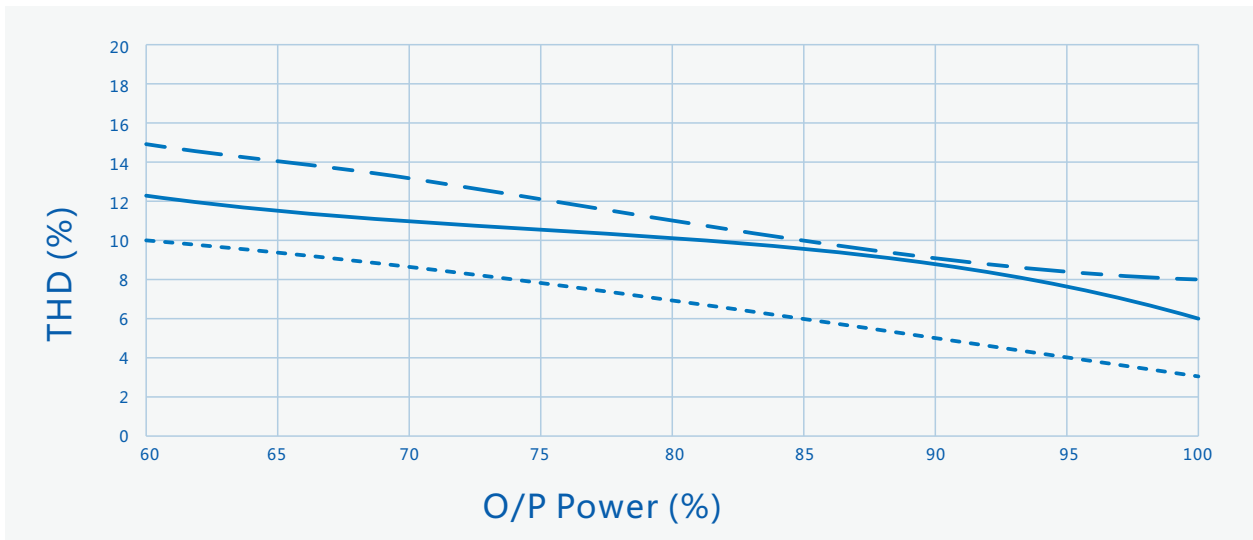

----- Vin=120Vac      ——— Vin=220Vac      - - - Vin=277Vac

# SS-320VP Series LED Driver

## Performance Curves:

### O/P Power Vs. Input Voltage

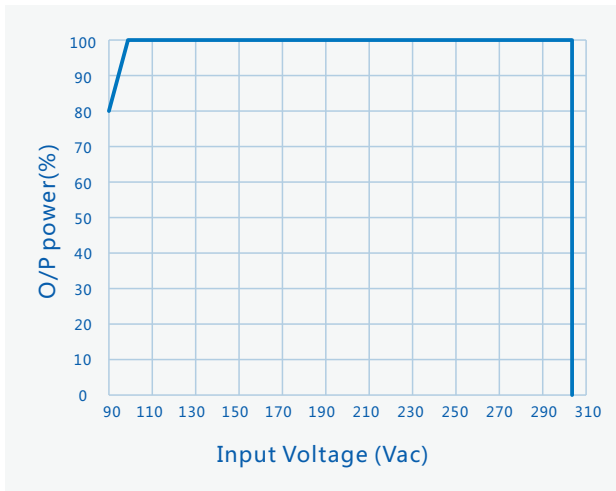

### O/P Power Vs. Case Temperature

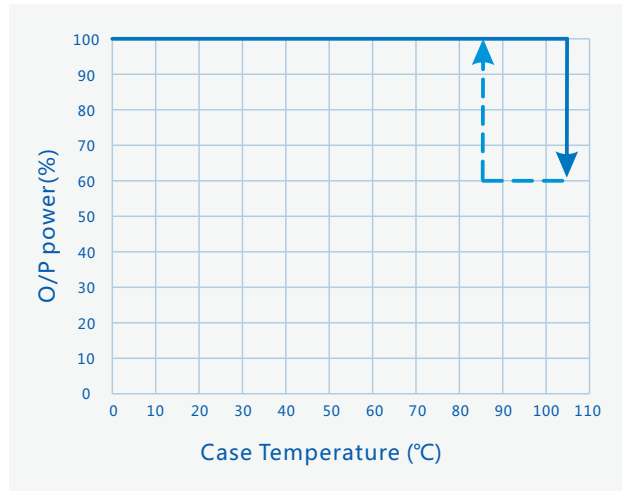

### O/P Power Vs. Dimming

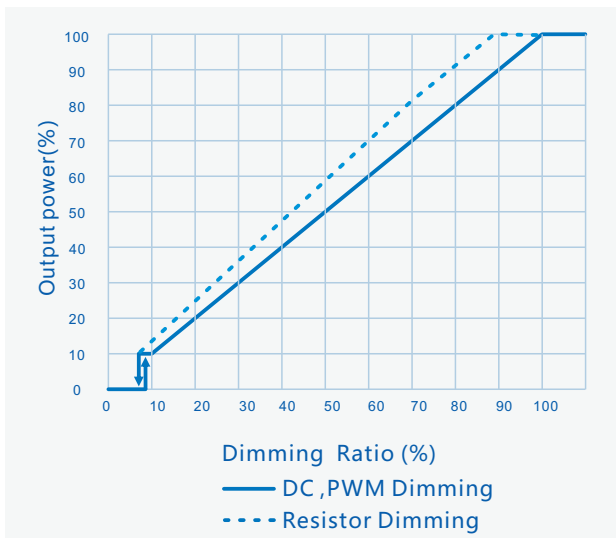

### Life Time Vs. Case Temperature

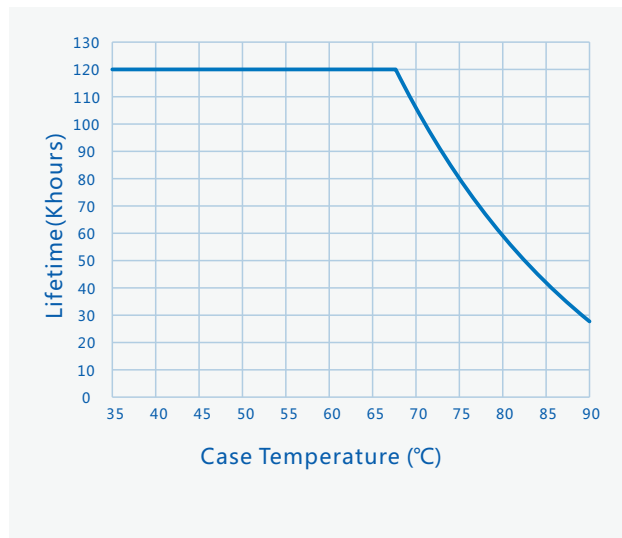

# SS-320VP Series LED Driver

## Constant Lumen Output

Constant Lumen Output are design to maintain fixture's stable output lumen by increasing driver's output current within driver's life span to counteract LED lumen degradation.

## Programming connection diagram :

Legacy Timer: Driver's O/P follows the pre-programmed timing curve after turn-on.

Auto-Adjust by Percentage: Driver's O/P will be adjusted by automatically changed dimming curve by the period percentage based on the latest 5 dimming curve.

Auto-Adjust by Mid-point: Driver's O/P will be adjusted by automatically changed dimming curve by mid-point based on the latest 5 dimming curve.



### Note:

Programming could be completed by off-line mode either without turn on the driver nor without PC, other than the traditional on-line mode.

# SS-320VP Series LED Driver

## Mechanical Characteristics

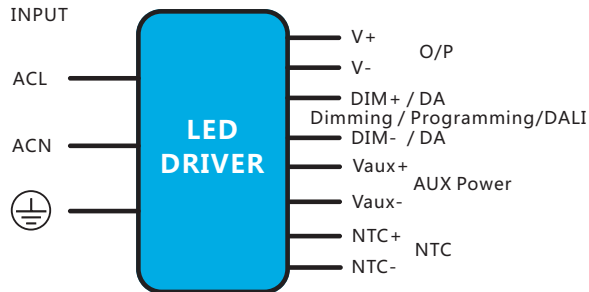

### AC Input Cable(Exposed Length 450±10mm):

Global model: SJOW,3\*17AWG,O.D: 8.0mm,Brown:L,Blue:N,Yellow/Green:⊕  
UL model: SJTW,3\*18AWG,O.D: 7.8mm,Black:L,White:N,Green:⊕

### DC O/P Cable(Exposed Length 250±10mm):

SS-320VP-56\*/SS-320VP-68\*:  
Global model: SJOW,2\*14AWG,O.D: 8.8mm,Brown:V+ , Blue:V-  
UL model: SJTW,2\*14AWG,O.D: 9.0mm,Red: V+ , Black: V-

SS-320VP-228\*/SS-320VP-428\*:  
Global model: SJOW,2\*17AWG,O.D: 7.7mm,Brown:V+ , Blue:V-  
UL model: SJTW,2\*18AWG,O.D: 7.3mm,Red: V+ , Black: V-

### DIM/AUX Power/Programming Cable (Exposed Length 220±10mm):

UL model: STYLE 21996 4\*22AWG , O.D: 5.6mm , Purple : DIM+ , Pink: DIM- , Black/White: Vaux+ , Blue/White: Vaux-

### NTC Cable(Exposed Length 300±10mm):

SS-320VP-56\*/SS-320VP-68\*:  
UL model: 21996 , 2\*22AWG , O.D: 4.7mm, Red/White: NTC+ , Blue/White: NTC-  
SS-320VP-228\*/SS-320VP-428\*:  
EU model: H05RN-F, 2\*0.75mm<sup>2</sup> , O.D: 6.4mm, Brown: NTC+ , Blue: NTC-

Name Description	Standard Code	mm(In.)
Case Length	L3	225(8.86)
Case Width	W1	89.5(3.52)
Case Height	H	44.5(1.75)
Overall Length	L1	252(9.92)
Mounting Hole Length	L2	238.3(9.38)
Mounting Hole Width	W2	40(1.57)
TC Point Position	X	115(4.53)
TC Point Position	Y	43(1.69)

#### Note :

- 1,Please follow the "LED Driver User Manual" obtained from SOSEN's official website for assembly.
- 2,AC Input Cable,DC O/P Cable,DIM/AUX Power/Programming Cable: Peeled length of cable:43±5mm, Tinned length of wire:10±2mm

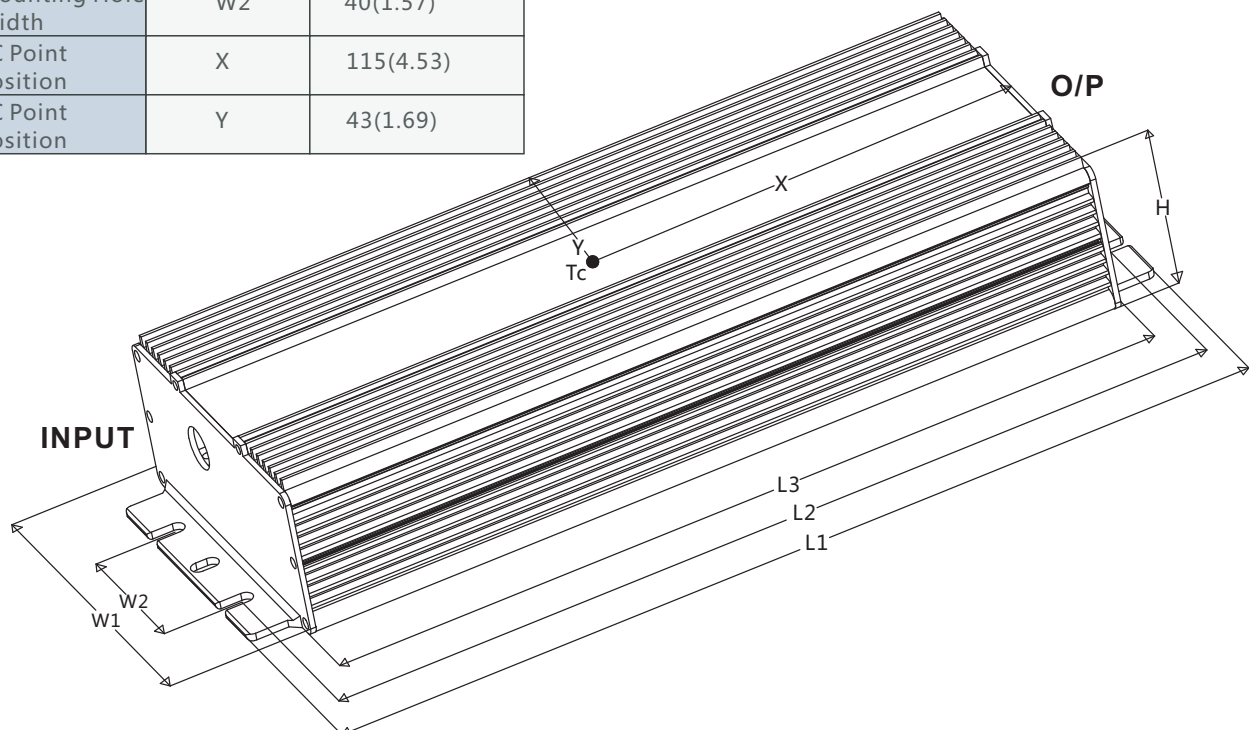

# SS-320VP Series LED Driver

---



## Assembly Tips

1. Dimming or AUX Power tinned connectors should be capped if not used to avoid dimming or AUX Power parts damage from external signals.

## Package

- Outside carton dimension: L×W×H =493mm×385mm×116mm;
- 7PCS/Carton;
- Net weight/Piece: 1.98kg;Gross weight/Carton: 14.86kg;
- Please refer to the product name, model number, manufacturer identification, QC PASS, manufacturing date on the package.

## Transportation

Packaging is designed suitable for transportation by trucks, vessels and flights. The products should be avoided direct sunlight and rain, loaded/unloaded with caution.

## Storage

The product storage meets the standard of the GB 3873 - 83.  
Products should be rechecked if stored for over 1 year before assembly.

## RoHS

Products comply with RoHS Directive (2011/65/EU) and amendment 2015/863/EU.

## Revision History

Version	Description of Update	Updated Date	Remark
V00	Original Release	2019/07/26	
V01	Update CCC Insulation Requirements	2019/11/11	
V02	Update Programming Diagram	2020/03/21	
V03	Update TC Point Position	2020/10/12	
V04	Update Dim to Off Point	2021/02/24	
V05	Update Tinned Length Of Wire	2021/07/02	
V06	Update DIM Cable Color	2021/09/02	
V07	Increase The Content Of DALI-2	2022/01/18	