



# SOSEN LED Driver, Your Smart Choice

## Specifications

### SS-240M Series LED Driver

Model: SS-240M-XX

Description: 240W LED Driver

Rev.: V07

Release Date: 2021-09-02

# SS-240M Series LED Driver

**SOSEN**  
LED DRIVER



**LED DRIVER**

**M Series**



## Features:

- Efficiency up to 93%
- Dimming: 0-10V,PWM,Resistor,Timing
- Dim-to-Off
- Surge protection: CM: 10kV, DM: 6kV
- AUX Power : 12V/0.3A
- Constant Lumen O/P
- Standby Power < 1.5W
- IP67
- Communication function with PC
- Type HL, suitable for hazardous locations
- Protections: SCP/OTP/UVP
- Warranty: 5 years



**IP67 Class P**

## Description:

SS-240M series are 240W constant current LED Driver with 249-528Vac input and wide O/P voltage range and adjustable O/P current by program. LED luminaries manufactures can easily design luminaries and reduce cost.

### Applications:

High bay lighting, Stadium lighting, Square lighting, Plant lighting, Fish lighting, Harbor lighting

## Model List:

Model	AC Input Range	Max. Pout	Vout Range	Full Power Vo Range	Iout	THD(Typ.)	PF(Typ.)	Eff.(Typ.)	Max.Tc
SS-240M-56BH	249-528Vac	240W	22-56V	36-56V	0.7-6.7A	10%	0.95	92%	90°C
SS-240M-228BH	249-528Vac	240W	114-228V	137-228V	0.35-1.75A	10%	0.95	93%	90°C
SS-240M-343BH	249-528Vac	240W	171-343V	228-343V	0.1-1.05A	10%	0.95	93%	90°C

Note:

- 1.Default Tested: at 347Vac, full load, Ta 25°C;
2. The performance of the LED Driver can be guaranteed within the full power Vo range. The voltage lower than full power Vo range, it is need to test the performance with the LED module.

# SS-240M Series LED Driver

## “\*” Means Additional Function

“*”	DALI (suffix:D)	AUX 12V (suffix:H)	NTC (suffix:N)	Timing	0-10V/PWM Dim /Resistor (suffix:B)	Remark
BH		✓		✓	✓	

## Input Characteristics:

Parameter	Min.	Typ.	Max.	Remark
Rated AC Input Range	277Vac		480Vac	
AC Input Range	249Vac		528Vac	
Input Frequency Range	47Hz	50/60Hz	63Hz	
Max Input Current			1.8A	277Vac, Full load
Max Input Power			270W	277Vac, Full load
Max Inrush Current(277Vac)			50A	Cold start
Max Inrush Current(347Vac)			70A	Cold start
Max Inrush Current(480Vac)			90A	Cold start
No Load Power			1.5W	347Vac/60Hz, Dim-off
Power Factor	0.93	0.95		347Vac/60Hz, Full load
	0.90			277-480Vac, 80-100% load
THD		7%	10%	347Vac/60Hz, Full load
			20%	277-480Vac, 80-100% load

# SS-240M Series LED Driver

## O/P Characteristics(SS-240M-56BH):

Parameter	Min.	Typ.	Max.	Remark
O/P Voltage Range	22V		56V	Power derated @22-36V
Rated O/P Voltage	36V		56V	$P_o = V_o \cdot I_o = 240W$ , Full load
Rated O/P Current	4.3A		6.7A	6.7A for 36V, 4.3A for 56V
Adj. O/P Current (AOC) Range	0.7A		6.7A	Adjustable by program
No Load Voltage			60V	
Efficiency @277Vac	89.0%	91.0%		O/P 56V/4.3A
Efficiency @347Vac	90.0%	92.0%		O/P 56V/4.3A
Efficiency @480Vac	90.0%	92.0%		O/P 56V/4.3A
O/P Current Tolerance	-5%		+5%	
O/P Current Ripple(PK-AV)		5%	10%	Full load
Start-up Current Overshoot			10%	Full load
Start-up Time			0.5S	277Vac, Full load
			0.5S	347Vac, Full load
Line Regulation	-1%		+1%	Full load
Load Regulation	-2%		+2%	
Temperature Coefficient	-0.03%/°C		+0.03%/°C	Tc: 0°C~90°C
OTP	90°C	100°C	110°C	> Tc Typ., Current derating < Tc Min., Current recovery
Short Circuit Protection				Driver will not be damaged, Constant current mode

# SS-240M Series LED Driver

## O/P Characteristics(SS-240M-228BH):

Parameter	Min.	Typ.	Max.	Remark
O/P Voltage Range	114V		228V	Power derated @114-137V
Rated O/P Voltage	137V		228V	$P_o = V_o * I_o = 240W$ , Full load
Rated O/P Current	1.05A		1.75A	1.75A for 137V, 1.05A for 228V
Adj. O/P Current (AOC) Range	0.35A		1.75A	Adjustable by program
No Load Voltage			230V	
Efficiency @277Vac	90.0%	91.0%		O/P 228V/1.05A
Efficiency @347Vac	91.0%	93.0%		O/P 228V/1.05A
Efficiency @480Vac	91.0%	93.0%		O/P 228V/1.05A
O/P Current Tolerance	-5%		+5%	
O/P Current Ripple(PK-AV)		5%	10%	Full load
Start-up Current Overshoot			10%	Full load
Start-up Time			0.5S	277Vac, Full load
			0.5S	347Vac, Full load
Line Regulation	-1%		+1%	Full load
Load Regulation	-2%		+2%	
Temperature Coefficient	-0.03%/°C		+0.03%/°C	Tc: 0°C~90°C
OTP	90°C	100°C	110°C	> Tc Typ., Current derating < Tc Min., Current recovery
Short Circuit Protection				Driver will not be damaged, Constant current mode

# SS-240M Series LED Driver

## O/P Characteristics(SS-240M-343BH):

Parameter	Min.	Typ.	Max.	Remark
O/P Voltage Range	171V		343V	Power derated @171-228V
Rated O/P Voltage	228V		343V	$P_o = V_o \cdot I_o = 240W$ , Full load
Rated O/P Current	0.7A		1.05A	1.05A for 228V, 0.7A for 343V
Adj. O/P Current (AOC) Range	0.1A		1.05A	Adjustable by program
No Load Voltage			360V	
Efficiency @277Vac	90.0%	91.0%		O/P 343V/0.7A
Efficiency @347Vac	91.0%	93.0%		O/P 343V/0.7A
Efficiency @480Vac	91.0%	93.0%		O/P 343V/0.7A
O/P Current Tolerance	-5%		+5%	
O/P Current Ripple(PK-AV)		5%	10%	Full load
Start-up Current Overshoot			10%	Full load
Start-up Time			0.5S	277Vac, Full load
			0.5S	347Vac, Full load
Line Regulation	-1%		+1%	Full load
Load Regulation	-2%		+2%	
Temperature Coefficient	-0.03%/°C		+0.03%/°C	Tc: 0°C~90°C
OTP	90°C	100°C	110°C	> Tc Typ., Current derating < Tc Min., Current recovery
Short Circuit Protection				Driver will not be damaged, Constant current mode

# SS-240M Series LED Driver

## Other Characteristics:

Parameter	Min.	Typ.	Max.	Remark	
AUX Power	O/P Voltage	11.5V	12V	12.5V	
	O/P Current			300mA	Operate max 15min at 400mA
0-10V Dimming (Optional)	Dim Vmax	0V		12V	Negative dimming by programming
	Dim Range	10%Ioset		100%Ioset	DIM+ source current 110uA .
	Rec.Dim Range	0V		10V	Dimming prohibits reverse connection.
PWM Dimming (Optional)	PWM High	9.8V		10.2V	Negative dimming by programming
	PWM Low	0V		0.3V	DIM+ source current 110uA .
	Frequency	1KHz		2KHz	Dimming prohibits reverse connection.
	PWM Duty	0%		100%	
Resistor Dimming (Optional)	Resistance	0Kohm		100Kohm	Negative dimming by programming
	Dim Range	10%		100%	DIM+ source current 110uA .
Dim to Off	Dim-off	7%	8%	9%	
	Dim-on	8%	9%	10%	
Timing Curve(Optional)	By programming				
Life Time(Tc≤65°C)	100,000 hours			80% Load	
Life Time(Tc≤75°C)	62,000 hours			80% Load	
MTBF	198,000 hours			347Vac,Full load, Ta=25°C (MIL-HDBK-217F)	
IP Grade	IP67				
Tc	90°C				
Warranty	5 years			Tc : 75°C	
Net Weight	1500g				
Dimension	254mm*71mm*39.6mm			L x W x H	

NOTE: 1,All the parameters above are tested Ta 25°C and LED load, unless specified.

2. When using resistor dimming (parallel connection of dimming wires), if the number of parallels is: N, the dimming resistor should be realized 0-100% dimming range, resistance value: 91KΩ/N.

# SS-240M Series LED Driver

## Environmental Requirements

Parameter	Min.	Typ.	Max.	Remark
Operating Temperature(Tcase)	-40°C	25°C	+90°C	
Storage Temperature	-40°C	25°C	+90°C	
Operation Humidity	10%RH		90%RH	
Storage Humidity	5%RH		95%RH	
Altitude	-65m		4000m	

## Safety and EMI/EMS Standards

Certification	Standard	Status	Remark
UL/cUL	UL8750	✓	
TUV	EN 61347-2-13:2014/A1:2017 EN 61347-1:2015 EN 62493:2015		
RCM	AS/NZS61347.2.13		
CCC	GB 19510.14-2009		
CE	EN 61347-2-13:2014 EN 61347-1:2008+A1:2011+A2:2013		

EMI/EMS	Criterion	Remark
Conduction Emission	FCC Part15: Subpart A ANSI 63.4:2014	Class A
Radiation Emission	FCC Part15: Subpart A ANSI 63.4:2014	Class A
Harmonic Current Emissions	IEC/EN 61000-3-2	Class C
Surge	IEC/EN61000-4-5	DM 6kV,CM 10kV,Criterion B
Ring Wave	IEC/EN 61000-4-12	DM 6kV,CM 10kV,Criterion B



# SS-240M Series LED Driver

## Safety Test Items:

Safety Test Items	Technical Indicators			Remark
	UL Insulation Requirements	TUV Insulation Requirements	CCC Insulation Requirements	
Insulation Requirements	UL Insulation Requirements	TUV Insulation Requirements	CCC Insulation Requirements	
Input-O/P	2U+1000	/	/	Reinforced insulation
Input-Case	2U+1000	/	/	Basic insulation
Input-Dim	2U+1000	/	/	Reinforced insulation
O/P-Dim	2U+1000	/	/	Basic insulation
O/P-Case	2U+1000	/	/	Basic insulation
Dim-Case	500	/	/	Basic insulation
Insulation Resistance	≥10MΩ			Input-O/P,Test voltage:500Vdc
Ground Resistance	≤0.1Ω			25A/1min
Leakage Current	≤0.75mA			480Vac

### NOTE:

1. SOSEN warrants the LED Driver itself complies with EMC standard. However, LED Driver's EMC should be re-checked when integrated into lighting systems due to unexpected interference as component.
2. Please short (ACL and ACN), (V+ and V-), (Dim+ and Dim - and Vaux+ and Vaux- and STB)when Hi-pot test.
- 3.The CCC withstand voltage test needs to disconnect the built-in lightning protection tube.According to the IEC 60598-1:14 standard section 10.2, the "built-in lightning protection tube" can be marked on the nameplate to disconnect the discharge tube on testing.
- 4." U " means the maximum working voltage between testing terminals.

## Performance Curves:

### Input Inrush Current

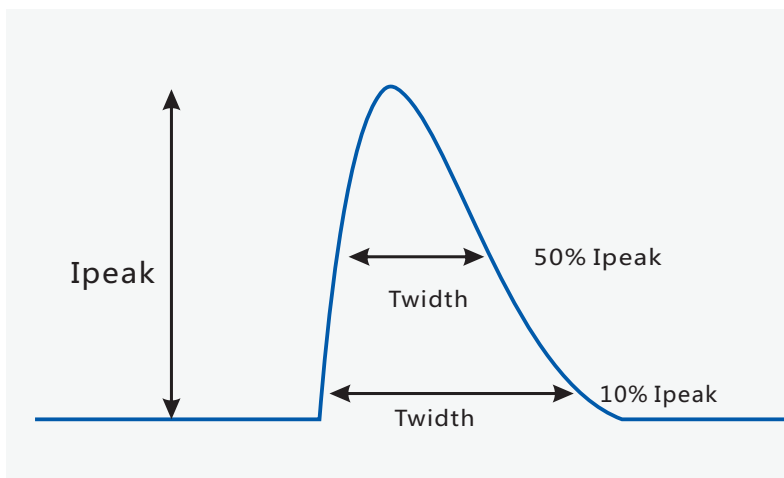

Vin	Ipeak	T(@10% of Ipeak)	T(@50% of Ipeak)
277Vac	50A	542uS	
347Vac	70A	564uS	
480Vac	90A	582uS	

# SS-240M Series LED Driver

## Performance Curves:

O/P Voltage Vs. O/P Current(Dim/AOC Window)

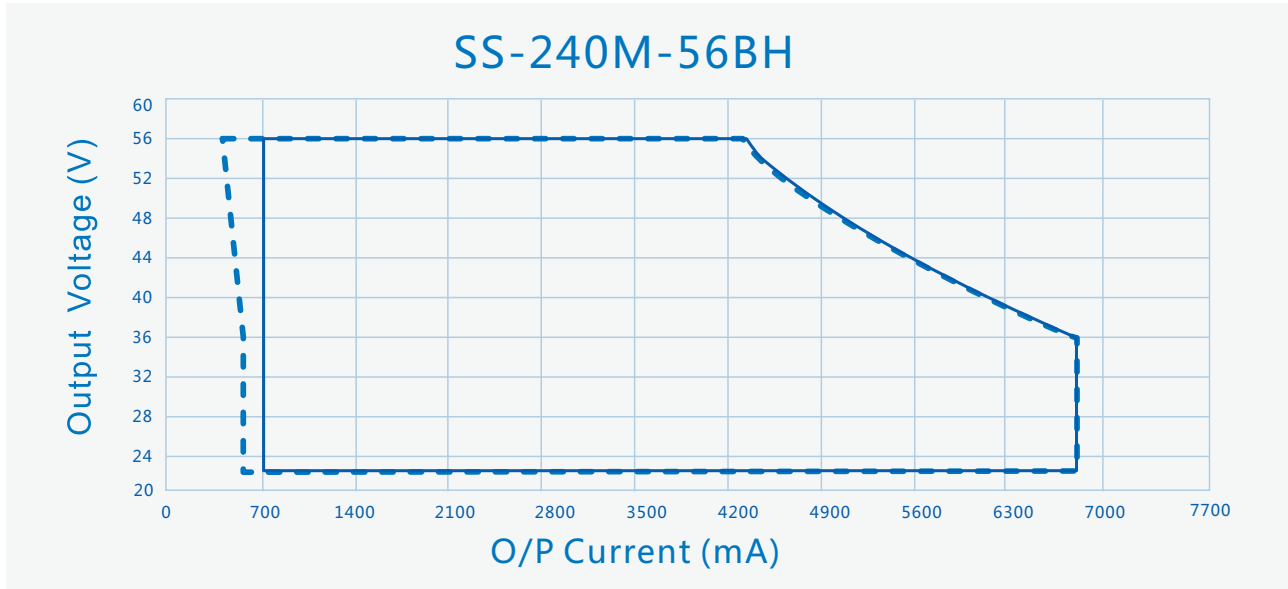

----- Dimming Window      ————— AOC Window

O/P Voltage Vs. O/P Current(Dim/AOC Window)

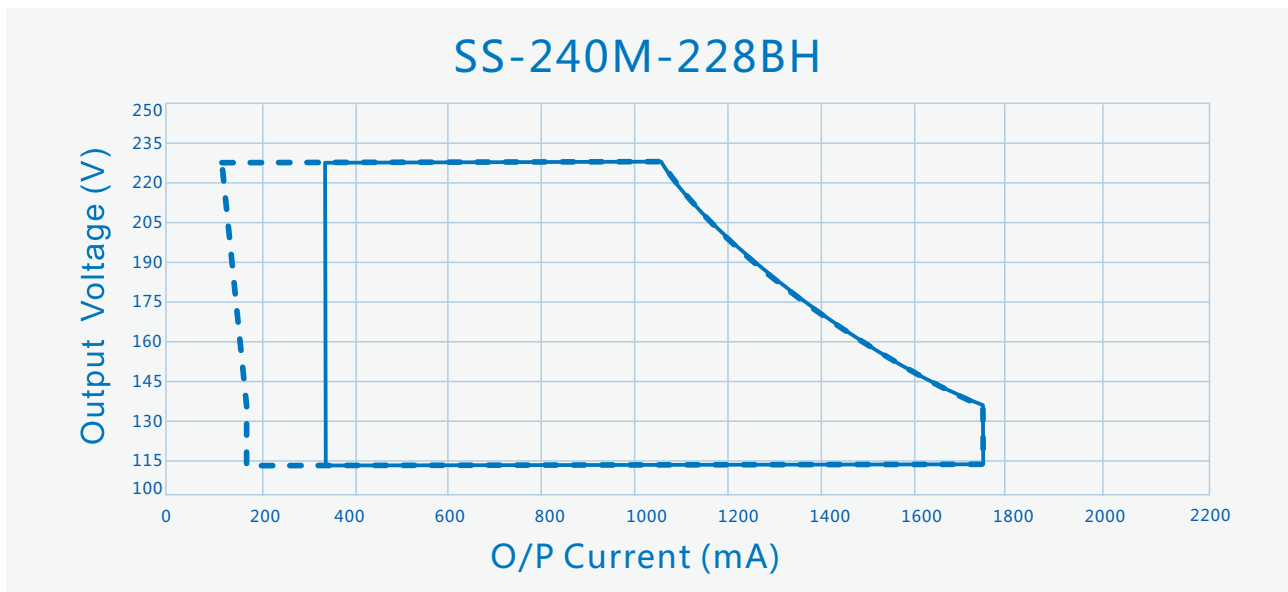

----- Dimming Window      ————— AOC Window

# SS-240M Series LED Driver

## Performance Curves:

O/P Voltage Vs. O/P Current(Dim/AOC Window)

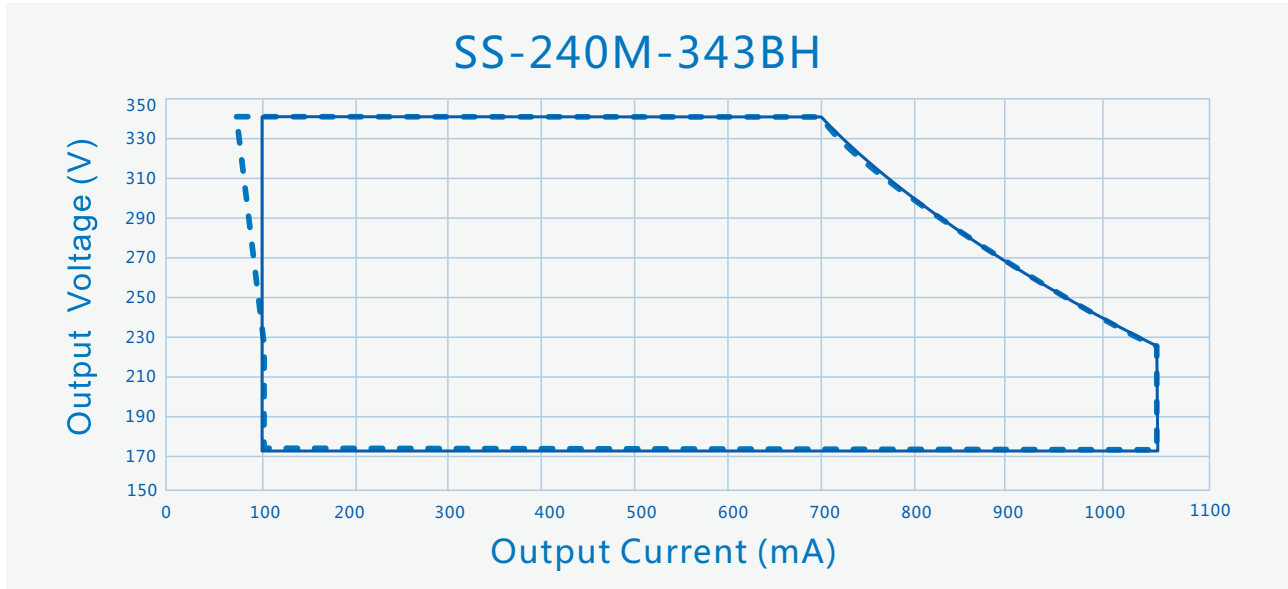

----- Dimming Window      ————— AOC Window

Efficiency Vs. O/P Voltage ( $V_{in}=277V_{ac}$ )

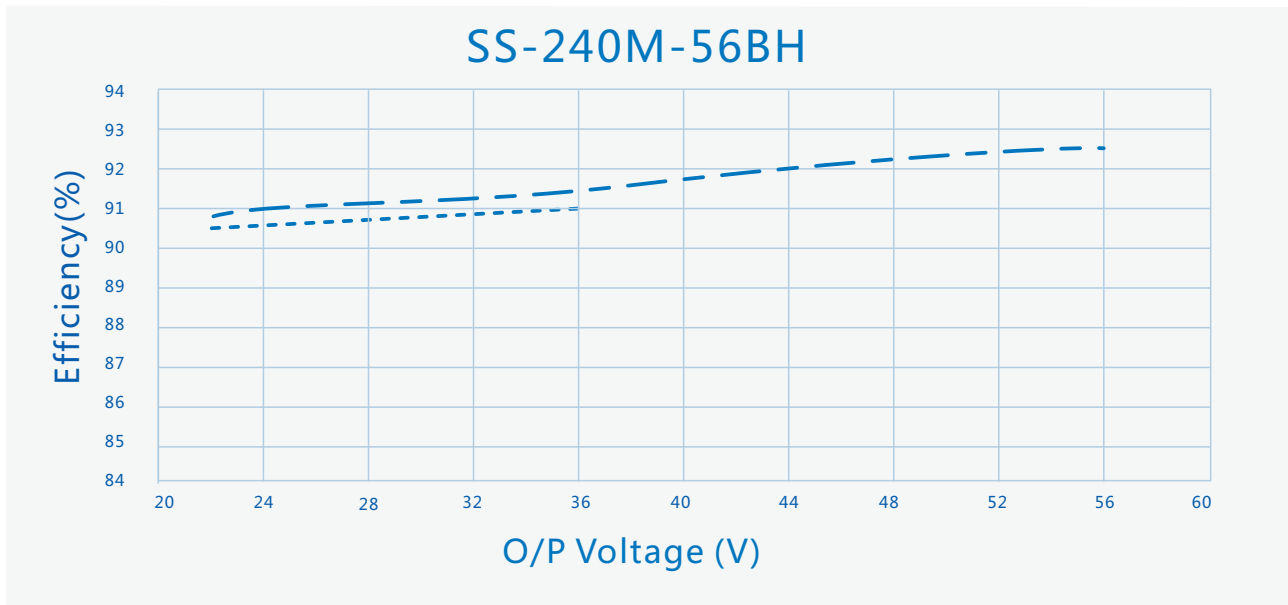

-----  $I_o=6700mA$

- - -  $I_o=4300mA$

# SS-240M Series LED Driver

## Performance Curves:

Efficiency Vs. O/P Voltage ( $V_{in}=347V_{ac}$ )

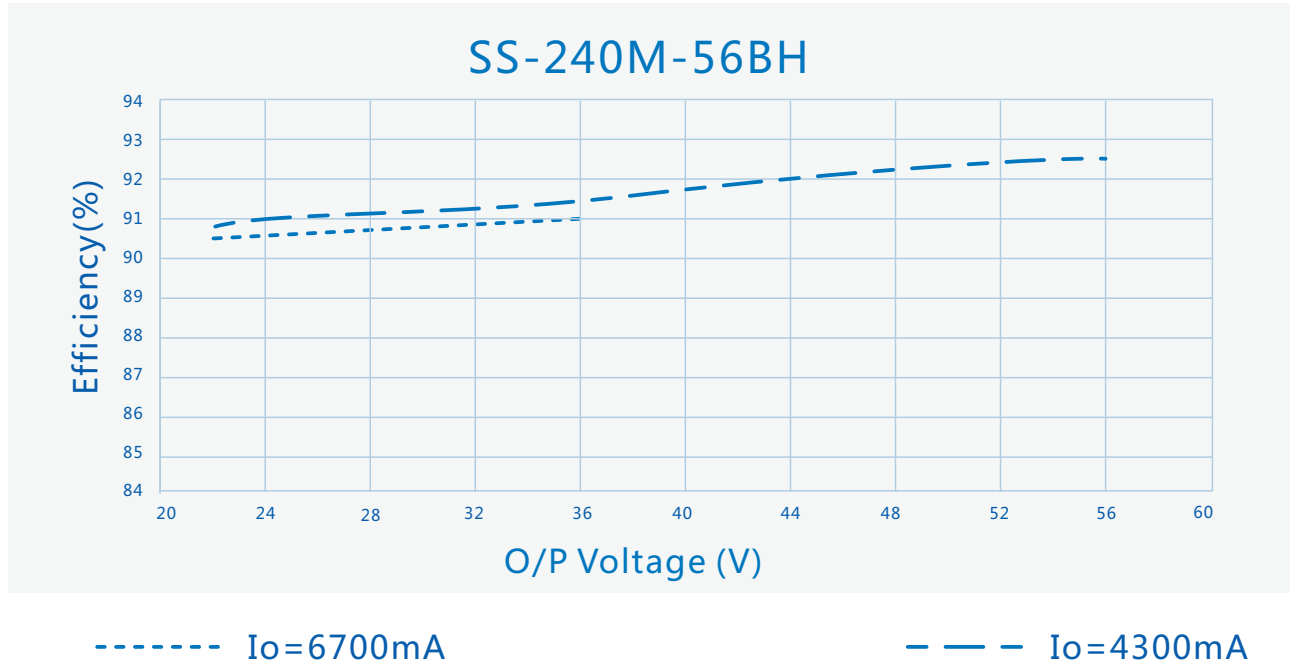

Efficiency Vs. O/P Voltage ( $V_{in}=480V_{ac}$ )

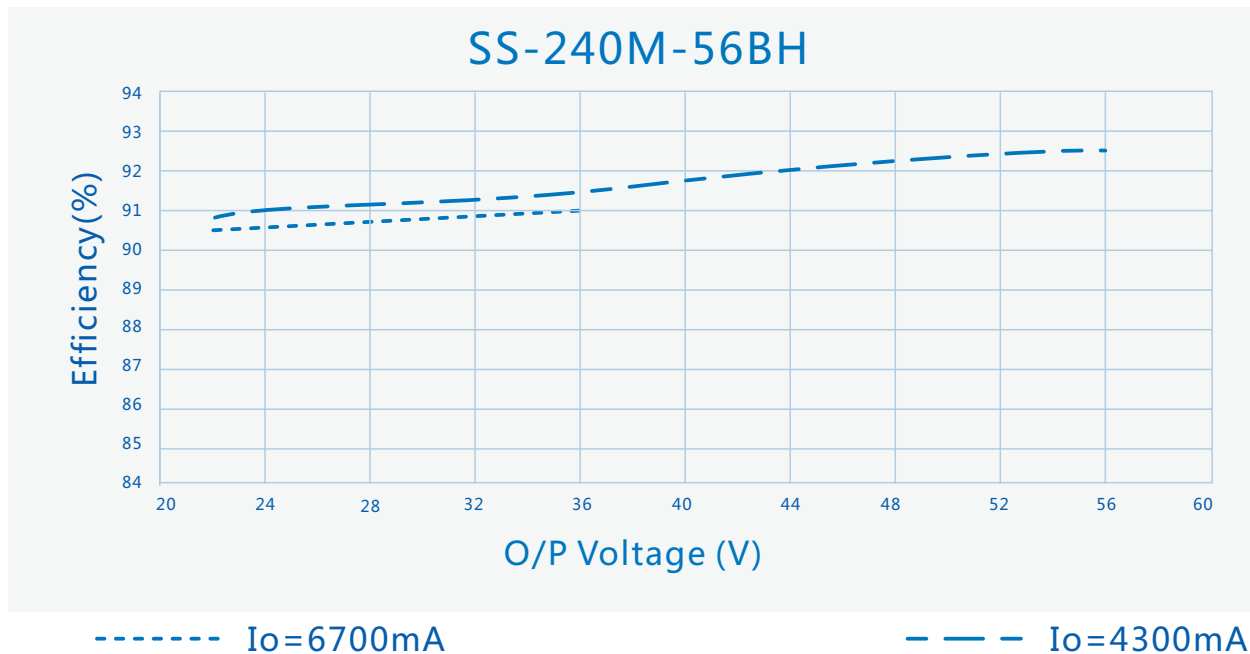

# SS-240M Series LED Driver

## Performance Curves:

Efficiency Vs. O/P Voltage ( $V_{in}=277V_{ac}$ )

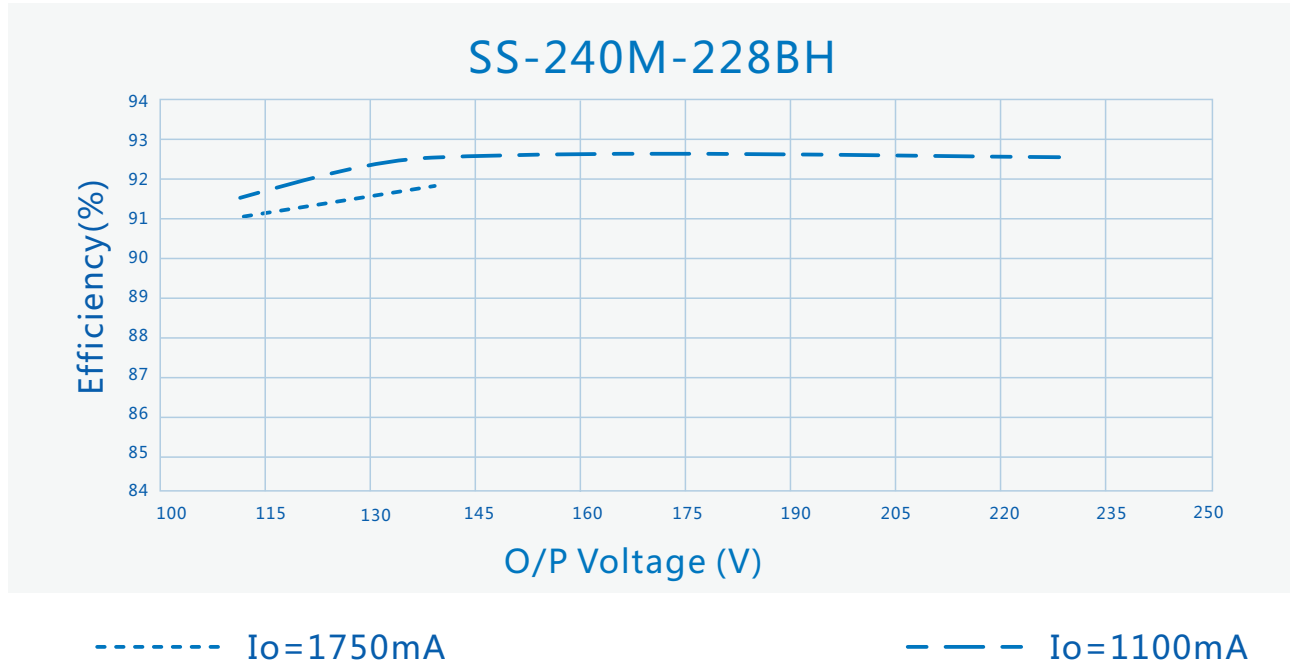

Efficiency Vs. O/P Voltage ( $V_{in}=347V_{ac}$ )

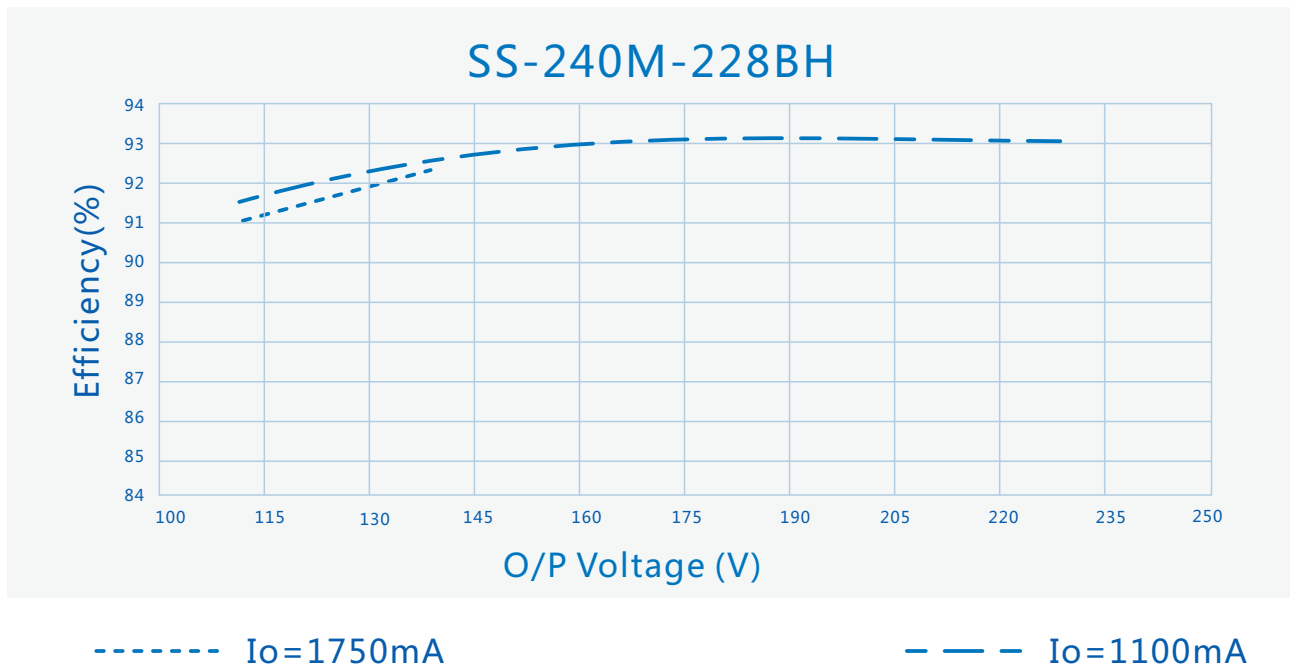

# SS-240M Series LED Driver

## Performance Curves:

Efficiency Vs. O/P Voltage ( $V_{in}=480V_{ac}$ )

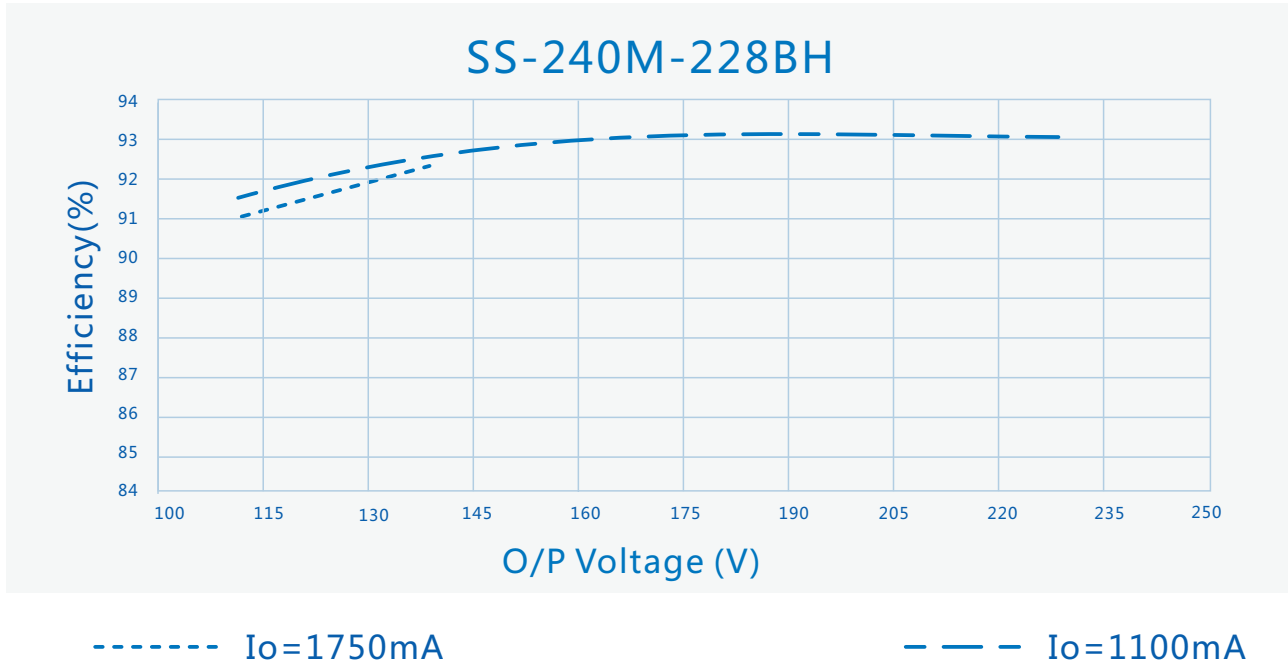

Efficiency Vs. O/P Voltage ( $V_{in}=277V_{ac}$ )

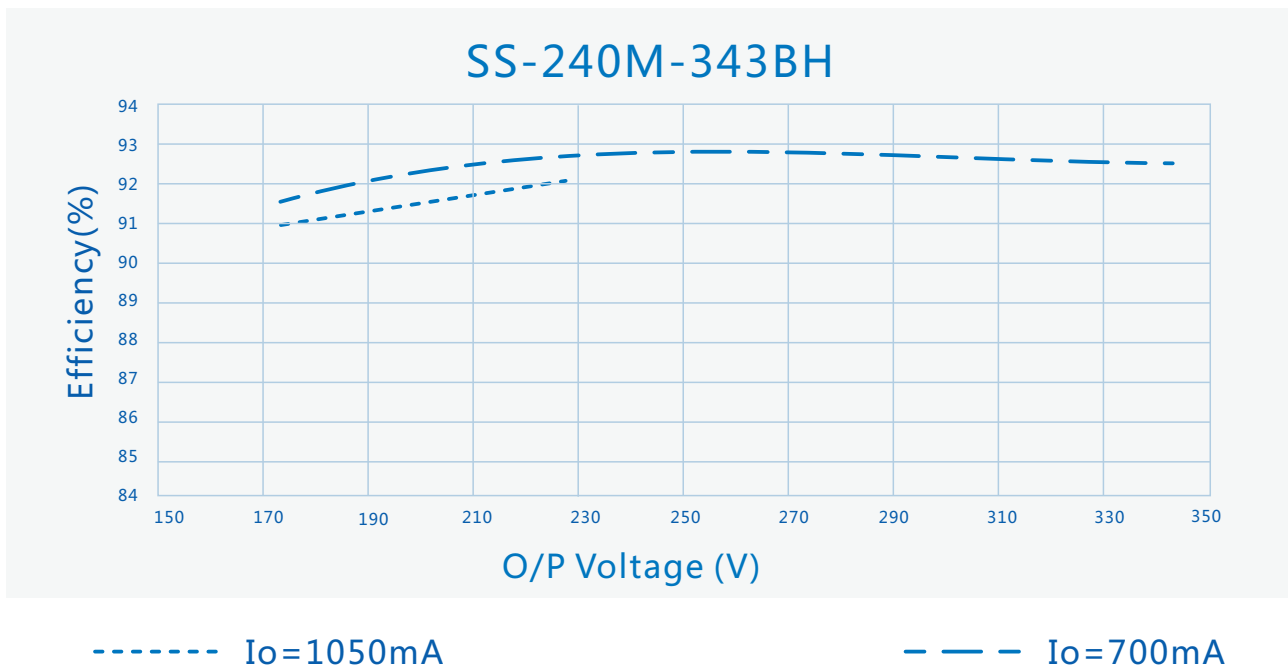

# SS-240M Series LED Driver

## Performance Curves:

Efficiency Vs. O/P Voltage ( $V_{in}=347V_{ac}$ )

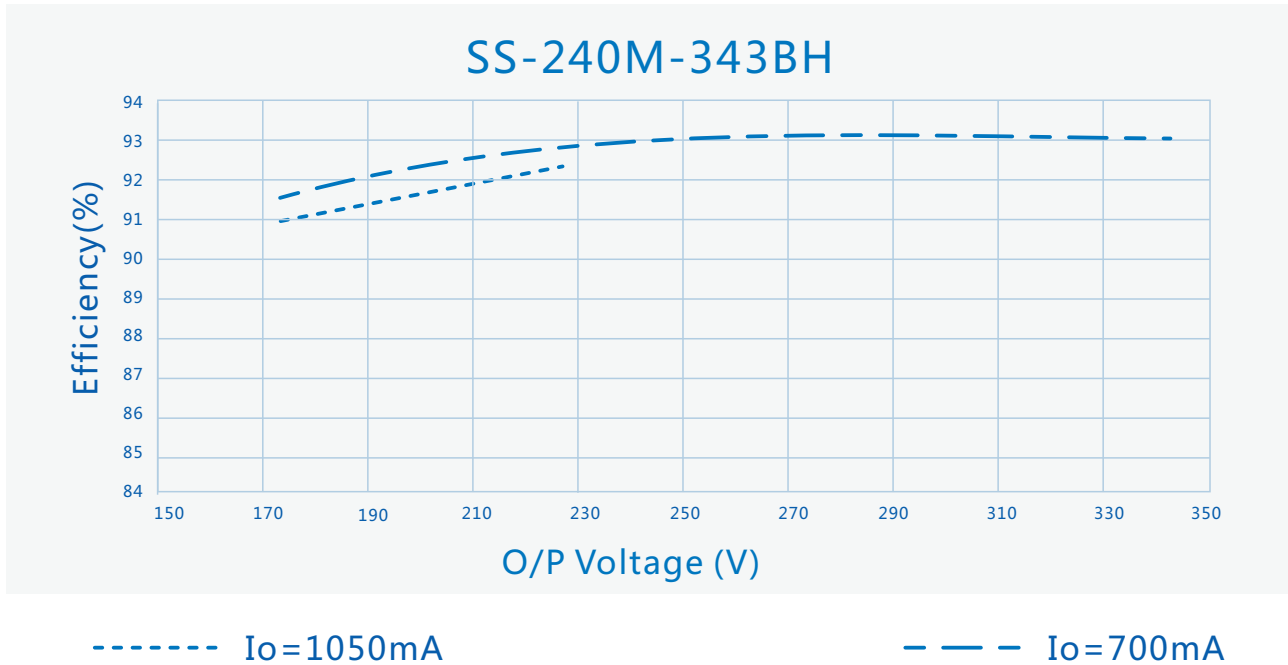

Efficiency Vs. O/P Voltage ( $V_{in}=480V_{ac}$ )

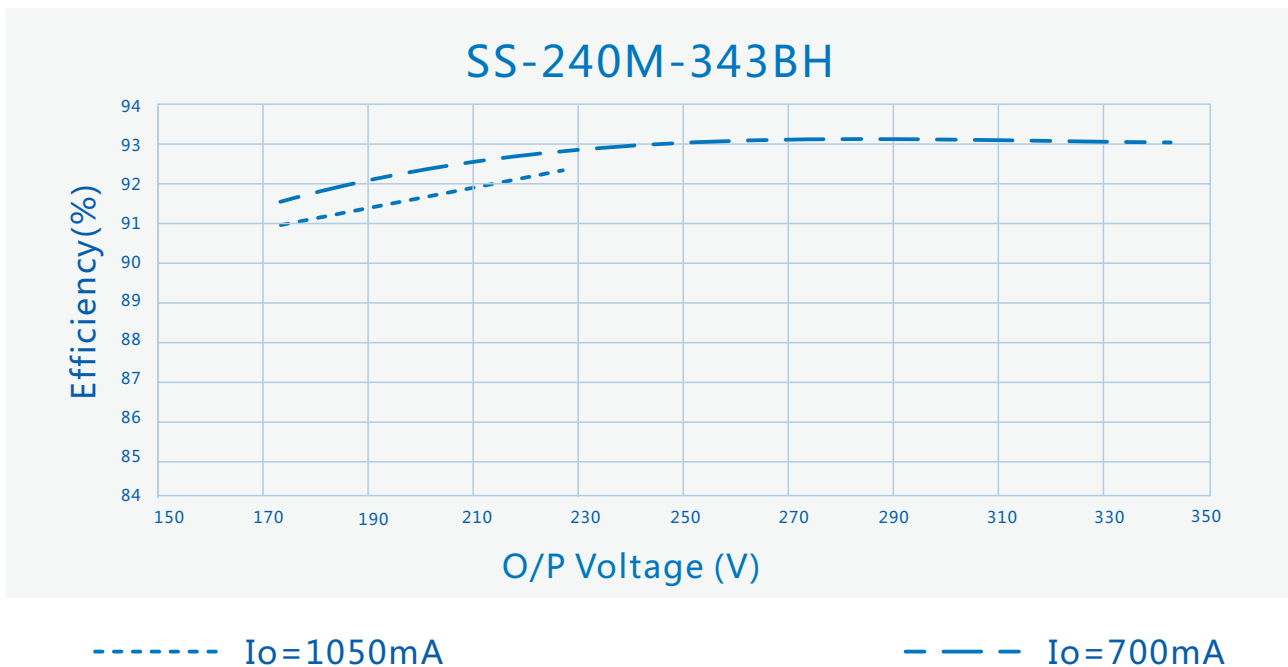

# SS-240M Series LED Driver

## Performance Curves:

### Power Factor Vs. O/P Power

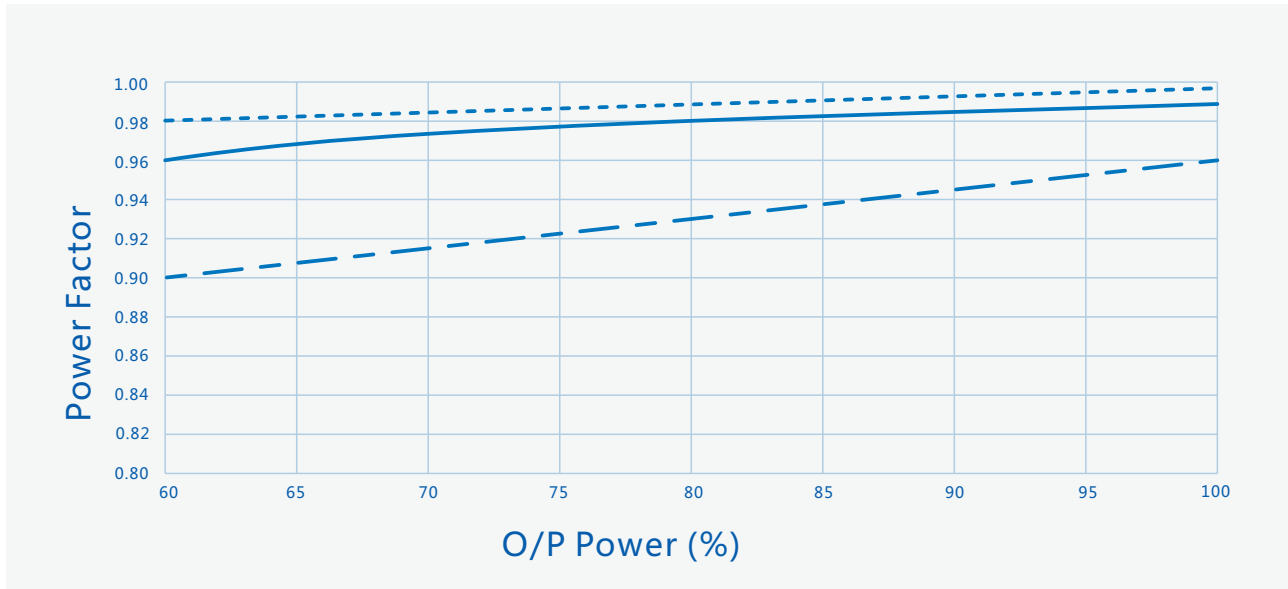

----- Vin=277Vac    ——— Vin=347Vac    - - - Vin=480Vac

### THD Vs. O/P Power

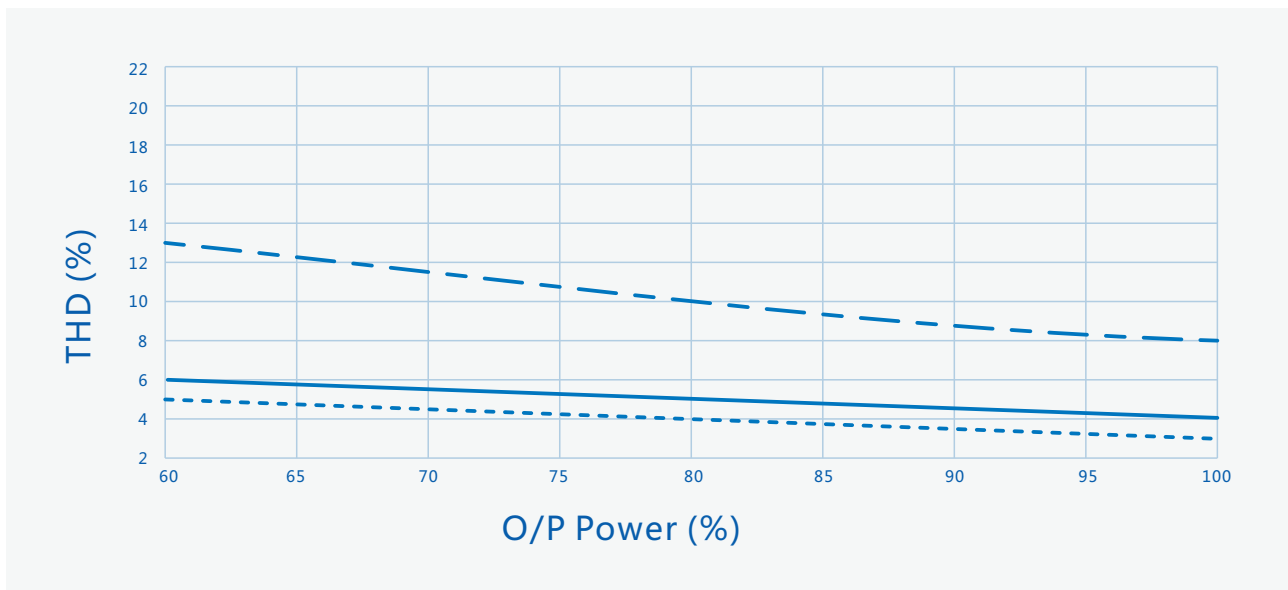

----- Vin=277Vac    ——— Vin=347Vac    - - - Vin=480Vac



# SS-240M Series LED Driver

## Performance Curves:

### O/P Power Vs. Input Voltage (Ta Max.50°C)

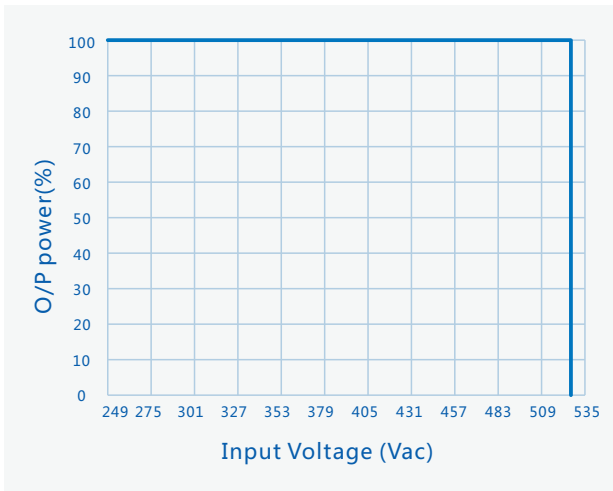

### O/P Power Vs. Case Temperature

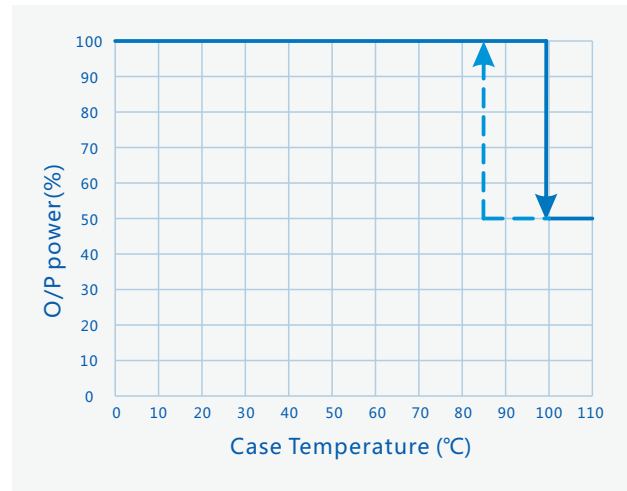

### O/P Power Vs. Dimming

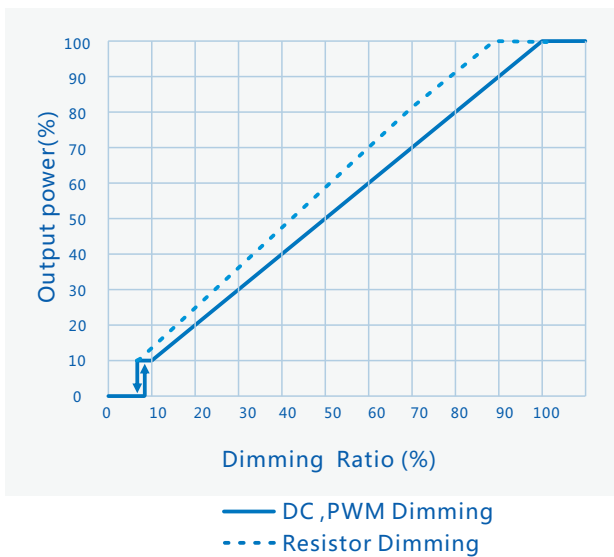

### Lifetime Vs. Case Temperature

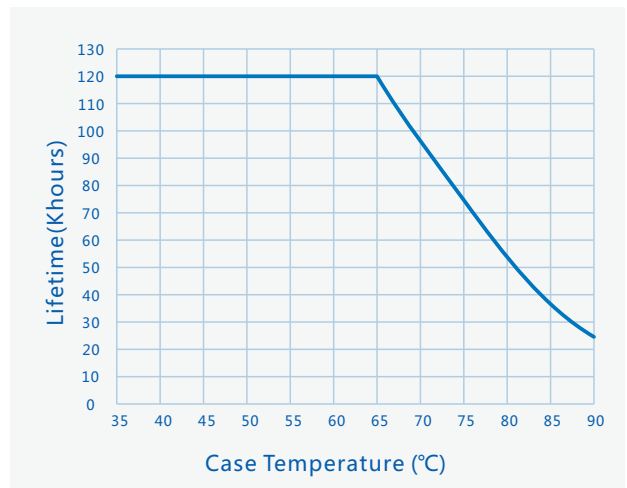

# SS-240M Series LED Driver

## Constant Lumen O/P

Constant Lumen O/P are design to maintain fixture's stable O/P lumen by increasing driver's O/P current within driver's life span to counteract LED lumen degradation.

## Programming connection diagram :

Legacy Timer: Driver's O/P follows the pre-programmed timing curve after turn-on.

Auto-Adjust by Percentage: Driver's O/P will be adjusted by automatically changed dimming curve by the period percentage based on the latest 5 dimming curve.

Auto-Adjust by Mid-point: Driver's O/P will be adjusted by automatically changed dimming curve by mid-point based on the latest 5 dimming curve.

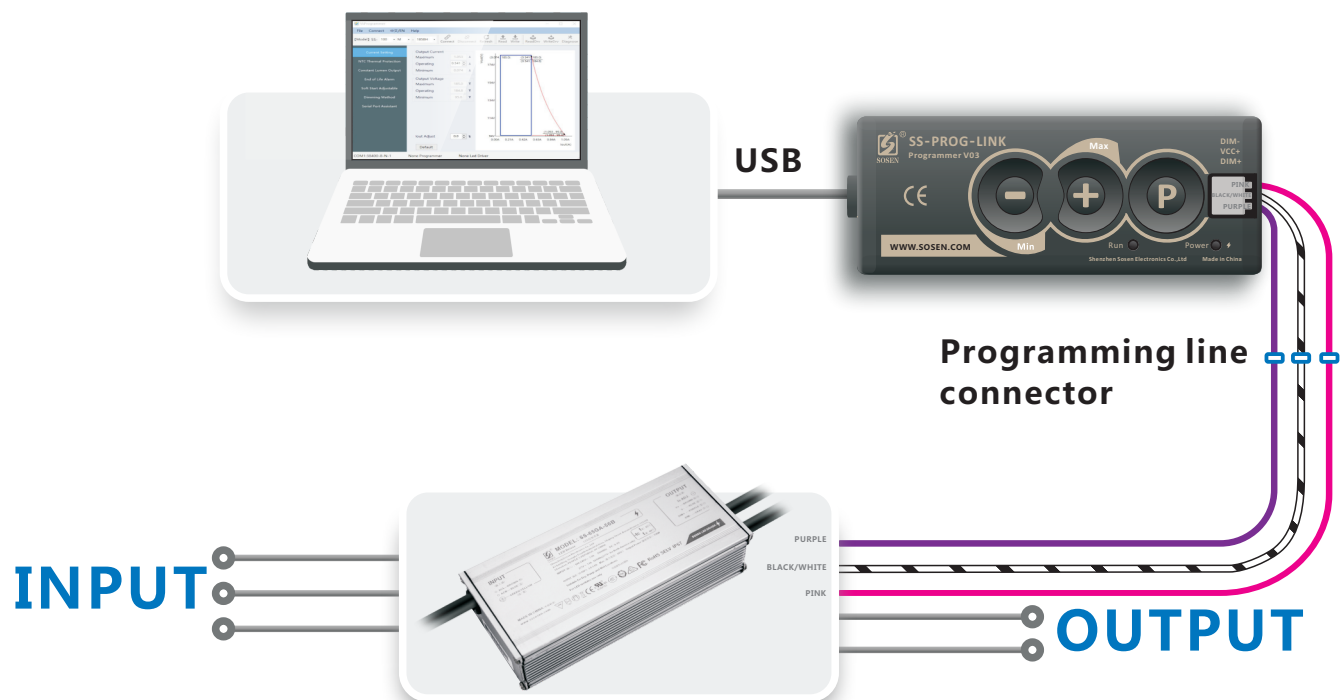

### Note:

Programming could be completed by off-line mode either without turn on the driver or without PC, other than the traditional on-line mode.

# SS-240M Series LED Driver

## Mechanical Characteristics

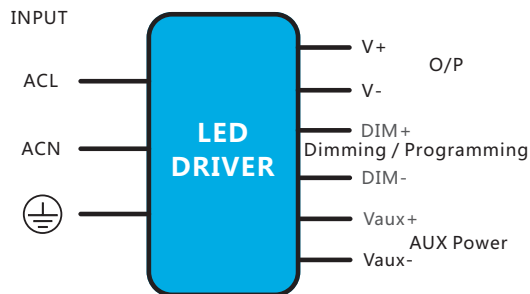

### AC Input Cable(Exposed Length 450±10mm):

UL model: STW,3\*18AWG,O.D: 9.4mm,Black:L,White:N,Green:⊕

### DC O/P Cable(Exposed Length 250±10mm):

SS-240M-56BH:

UL model: SJTW,2\*16AWG,O.D: 7.8mm,Red:V+ , Black:V-

SS-240M-228BH/SS-240M-343BH:

UL model: SJTW,2\*18AWG,O.D: 7.3mm,Red:V+ , Black:V-

### DIM/AUX Power/Programming Cable (Exposed Length 220±10mm):

UL model: STYLE 21996,4\*22AWG, O.D: 5.6mm,Purple : DIM+ , Pink: DIM-  
Black/White: Vaux+ , Blue/White: Vaux-

Name Description	Standard Code	mm(In.)
Case Length	L3	230(9.06)
Case Width	W1	71(2.8)
Case Height	H	39.6(1.56)
Overall Length	L1	254(10)
Mounting Hole Length	L2	241(9.49)
Mounting Hole Width	W2	34(1.34)
TC Point Position	X	97(3.82)
TC Point Position	Y	34(1.34)

Note :

1,Please follow the "LED Driver User Manual" obtained from SOSEN's official website for assembly.

2,AC Input Cable,DC O/P Cable,DIM/AUX Power/Programming Cable:  
Peeled length of cable:43±5mm, Tinned length of wire:10±2mm

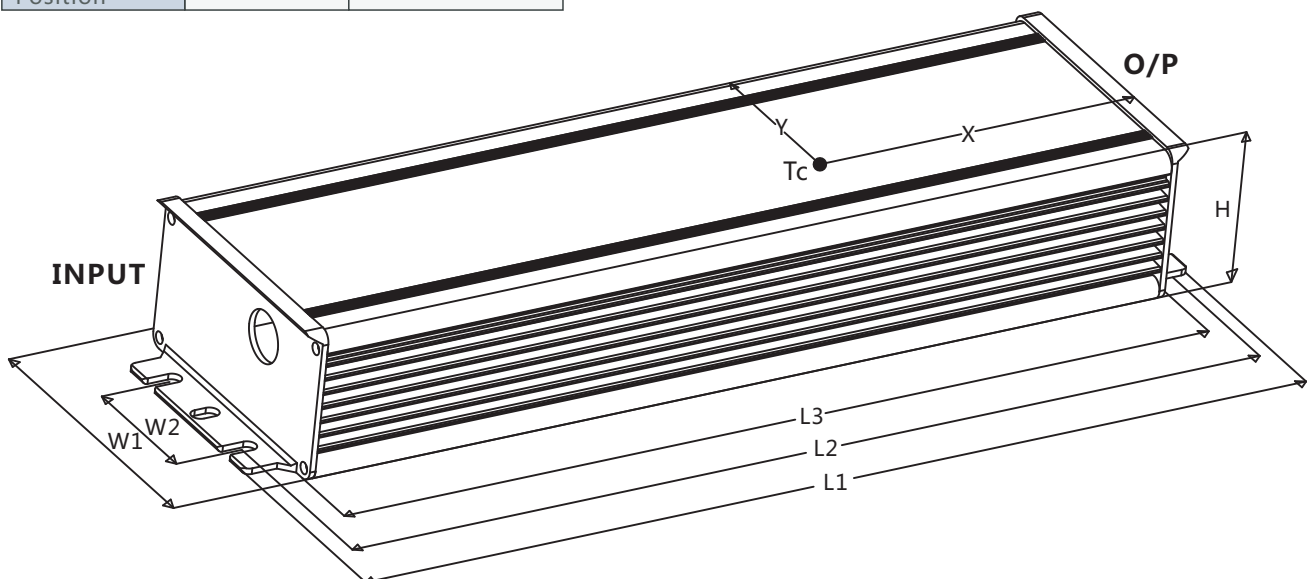

# SS-240M Series LED Driver

---



## Assembly Tips

1. Dimming or AUX Power tinned connectors should be capped if not used to avoid dimming or AUX Power parts damage from external signals.

## Package

- Outside carton dimension: L×W×H =493mm×385mm×116mm;
- 7PCS/Carton;
- Net weight/Piece: 1.5kg;Gross weight/Carton: 11.5kg;
- Please refer to the product name, model number, manufacturer identification, QC PASS, manufacturing date on the package.

## Transportation

Packaging is designed suitable for transportation by trucks, vessels and flights. The products should be avoided direct sunlight and rain, loaded/unloaded with caution.

## Storage

The product storage meets the standard of the GB 3873 - 83.  
Products should be rechecked if stored for over 1 year before assembly.

## RoHS

Products comply with RoHS Directive (2011/65/EU) and amendment 2015/863/EU.

## Revision History

Version	Description of Update	Updated Date	Remark
V00	Original Release	2018/10/18	
V01	Update Structure Diagram	2019/04/04	
V02	Update Performance Curve	2019/05/29	
V03	Update Cable Length	2019/07/25	
V04	Update Programming Connection Diagram	2020/04/24	
V05	Update Dim to Off Point	2020/12/27	
V06	Update Tinned Length Of Wire	2021/07/02	
V07	Update DIM Cable Color	2021/09/02	