



SOSEN LED Driver, Your Smart Choice

Specifications

SS-100VA Series LED Driver

Model: SS-100VA-XX*

Description: 96W LED Driver

Rev.: V06

Release Date: 2021-09-02

SS-100VA Series LED Driver

SOSEN
LED DRIVER



LED DRIVER

VA Series



Features:

- Efficiency up to 91%
- Isolated dimming: 1-10V, PWM, Resistor, Timing
- IP67
- Protections: SCP/OTP/OVP/OPP
- Class P
- Class 2
- Type HL, suitable for hazardous locations
- Surge protection: CM: 10kV, DM: 6kV
- Warranty: 5 years



IP67 Class P

Description :

SS-100VA is a rectangular driver with 90-305Vac input, the 96W model are designed for street and area lights with IP67 and 10kV/6kV surge protection. It has UL listed mark with Class P and Type HL rated.

Model List:

Model	AC Input Range	Max. Pout	Vout Range	Full Power Vo Range	Iout	THD(Typ.)	PF(Typ.)	Eff.(Typ.)	Max.Tc
SS-100VA-40*	90-305Vac	96W	22-40V	32-40V	2.3-3.0A	8%	0.98	90%	90°C
SS-100VA-56*	90-305Vac	96W	22-56V	42-56V	1.6-2.3A	8%	0.98	91%	90°C

Note:

- 1.Default Tested: at 220Vac, full load, Ta 25°C.
- 2.The performance of the LED Driver can be guaranteed within the full power Vo range.The voltage lower than full power Vo range, it is need to test the performance with the LED module;
3. "*" Optional B or space in the place of * means additional function.
 - Space is the base model without any optional function;
 - Suffix B for model with 3-in-1 dimming (1-10V, PWM, Resistor);
 - Suffix T for model with Timing.

SS-100VA Series LED Driver

Input Characteristics:

Parameter	Min.	Typ.	Max.	Remark
Rated AC Input Range	100Vac		277Vac	
AC Input Range	90Vac		305Vac	
Input Frequency Range	47Hz	50/60Hz	63Hz	
Max Input Current			1.2A	100Vac, Full load
Max Input Power			108W	100Vac, Full load
Max Inrush Current(120Vac)			100A	Cold start
Max Inrush Current(220Vac)			150A	Cold start
Max Inrush Current(277Vac)			160A	Cold start
No Load Power			3W	220Vac/50Hz, No load
Power Factor	0.95	0.98		220Vac/50Hz, Full load
	0.90			100-277Vac/50Hz, 70-100% load
THD		8%	10%	220Vac/50Hz, Full load
			20%	100-277Vac/50Hz, 70-100% load

SS-100VA Series LED Driver

O/P Characteristics(SS-100VA-40*):

Parameter	Min.	Typ.	Max.	Remark
O/P Voltage Range	22V		40V	Power derated @22-32V
Rated O/P Voltage	32V		40V	$P_o = V_o \cdot I_o = 96W$, Full load
Rated O/P Current	2.4A		3.0A	3.0A for 32V, 2.4A for 40V
Adj. O/P Current (AOC) Range	2.3A		3.0A	
No Load Voltage			48V	
Efficiency @120Vac	89.0%	90.0%		O/P 40V/2.4A
Efficiency @220Vac	89.5%	90.5%		O/P 40V/2.4A
Efficiency @277Vac	90.0%	91.0%		O/P 40V/2.4A
O/P Current Tolerance	-5%		+5%	
O/P Current Ripple(PK-AV)		5%	10%	Full load
Start-up Current Overshoot			10%	Full load
Start-up Time			0.5S	120Vac
			0.5S	220Vac
Line Regulation	-2%		+2%	Full load
Load Regulation	-2%		+2%	
Temperature Coefficient	-0.03%/°C		+0.03%/°C	Tc:0°C~90°C
OTP	90°C	100°C	110°C	>Tc Typ., Current derating <Tc Min., Current recovery
Short Circuit Protection			15W	Driver will not be damaged, Hiccup mode

SS-100VA Series LED Driver

O/P Characteristics(SS-100VA-56*):

Parameter	Min.	Typ.	Max.	Remark
O/P Voltage Range	22V		56V	Power derated @22-42V
Rated O/P Voltage	42V		56V	$P_o = V_o \cdot I_o = 96W$, Full load
Rated O/P Current	1.72A		2.3A	2.3A for 42V, 1.72A for 56V
Adj. O/P Current (AOC) Range	1.6A		2.3A	
No Load Voltage			60V	
Efficiency @120Vac	89.0%	90.0%		O/P 48V/2.0A
Efficiency @220Vac	89.5%	90.5%		O/P 48V/2.0A
Efficiency @277Vac	90.0%	91.0%		O/P 48V/2.0A
O/P Current Tolerance	-5%		+5%	
O/P Current Ripple(PK-AV)		5%	10%	Full load
Start-up Current Overshoot			10%	Full load
Start-up Time			0.5S	120Vac
			0.5S	220Vac
Line Regulation	-2%		+2%	Full load
Load Regulation	-2%		+2%	
Temperature Coefficient	-0.03%/°C		+0.03%/°C	Tc:0°C~90°C
OTP	90°C	100°C	110°C	>Tc Typ., Current derating <Tc Min., Current recovery
Short Circuit Protection			15W	Driver will not be damaged, Hiccup mode

SS-100VA Series LED Driver

Other Characteristics:

Parameter		Min.	Typ.	Max.	Remark
1-10V Dimming (Optional)	Dim Vmax	0V		12V	DIM+ source current 110uA.
	Dim Range	10%Iomax		100%Ioset	Dimming prohibits reverse connection
	Rec.Dim Range	1V		10V	
PWM Dimming (Optional)	PWM High	9.8V		10.2V	DIM+ source current 110uA.
	PWM Low	0V		0.3V	Dimming prohibits reverse connection
	Frequency	1KHz		2KHz	
	PWM Duty	10%		100%	
Resistor Dimming (Optional)	Resistance	10Kohm		100Kohm	DIM+ source current 110uA.
	Dim Range	10%Iomax		100%Ioset	
Timing Curve(Optional)	By programming			Set by program (Externally programmable)	
Lifetime(Tc≤75°C)	≥62,000 hours			80% load	
MTBF	236,000 hours			220Vac,Full load, Ta=25°C (MIL-HDBK-217F)	
IP Grade	IP67				
Tc	90°C				
Warranty	5 years			Tc : 75°C	
Net Weight	690g				
Dimension	179mm*66mm*35.5mm			L x W x H	

NOTE: All the parameters above are tested Ta 25°C and LED load, unless specified.

SS-100VA Series LED Driver

Environmental Requirements

Parameter	Min.	Typ.	Max.	Remark
Operating Temperature(Tcase)	-40°C	25°C	+90°C	
Storage Temperature	-40°C	25°C	+90°C	
Operation Humidity	10%RH		90%RH	
Storage Humidity	5%RH		95%RH	
Altitude	-65m		4000m	

Safety and EMI/EMS Standards

Certification	Standard	Status	Remark
UL/cUL	UL8750	✓	
ENEC	EN 61347-1:2015 EN 61347-2-13:2014 EN 61347-2-13:2014/A1:2017	✓	
RCM	AS/NZS61347.2.13	✓	
CCC	GB 19510.14-2009	✓	
CE	EN 61347-2-13:2014 EN61347-1:2008+A1:2011+A2:2013	✓	

EMI/EMS	Criterion	Remark
Conduction Emission	EN55015:2013+A1:2015	
Radiation Emission	EN55015:2013+A1:2015	
Harmonic Current Emissions	IEC/EN 61000-3-2	Class C
Surge	IEC/EN 61000-4-5	DM: 6kV,CM: 10kV,Criterion B
Ring Wave	IEC/EN 61000-4-12	DM: 6kV,CM: 6kV,Criterion B

SS-100VA Series LED Driver

Safety Test Items:

Safety test items	Technical Indicators			Remark
	UL Insulation Requirements	ENEC Insulation Requirements	CCC Insulation Requirements	
Insulation Requirements	UL Insulation Requirements	ENEC Insulation Requirements	CCC Insulation Requirements	
Input-O/P	1600Vac	3000Vac	3750Vac	Reinforced insulation
Input-Case	1600Vac	1500Vac	1875Vac	Basic insulation
Input-Dim	1600Vac	3000Vac	3750Vac	Reinforced insulation
O/P-Dim	1600Vac	1000Vac	1000Vac	Basic insulation
O/P-Case	500Vac	1000Vac	1000Vac	Basic insulation
Dim-Case	500Vac	250Vac	500Vac	Basic insulation
Insulation Resistance	≥10MΩ			Input-O/P,Test voltage:500Vdc
Ground Resistance	≤0.1Ω			25A/1min
Leakage Current	≤0.75mA			277Vac

NOTE:

1. SOSEN warrants the LED Driver itself meets with EMC standard. However, LED Driver's EMC should be re-checked when integrated into lighting systems due to unexpected interference as component.
2. Please short Line and Neutral, LED+ and LED-, Dim+ and Dim - when Hi-pot test.
- 3.The CCC withstand voltage test needs to disconnect the built-in lightning protection tube.According to the IEC 60598-1:14 standard section 10.2, the "built-in lightning protection tube" can be marked on the nameplate to disconnect the discharge tube on testing.

Performance Curves:

Input Inrush Current

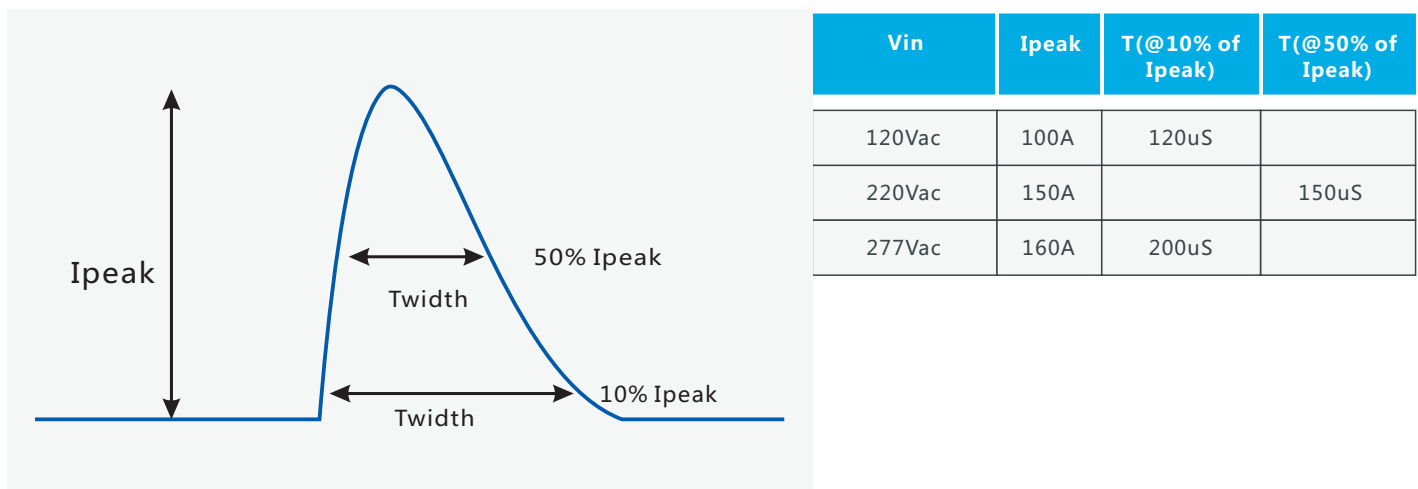

SS-100VA Series LED Driver

Performance Curves:

O/P Voltage Vs. O/P Current(Dim/AOC Window)

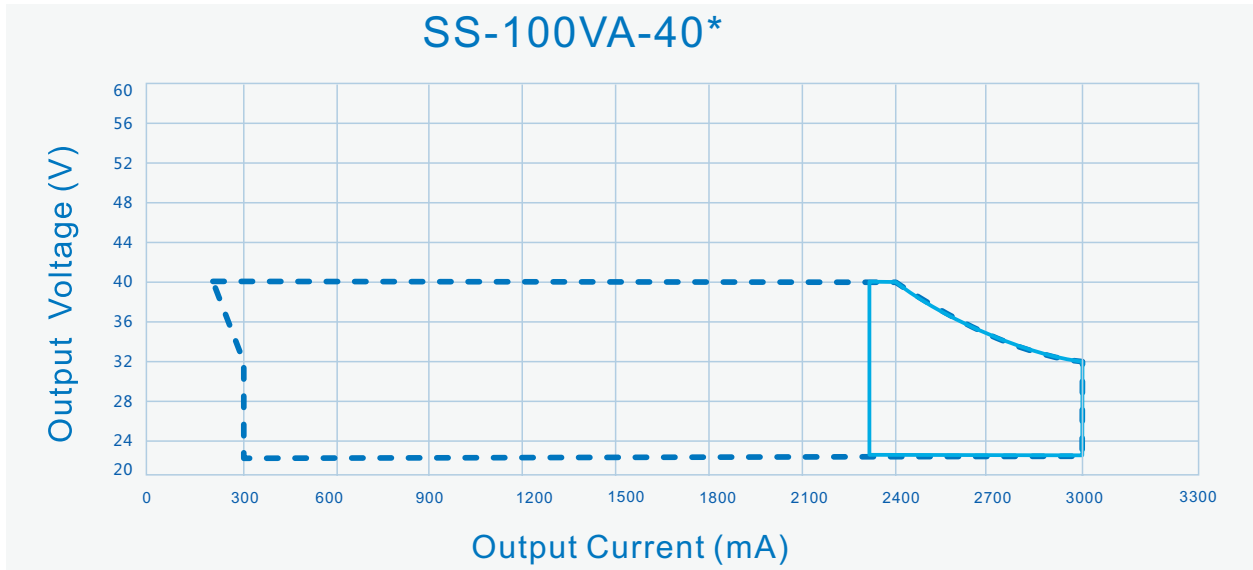

----- Dimming Window ————— AOC Window

O/P Voltage Vs. O/P Current(Dim/AOC Window)

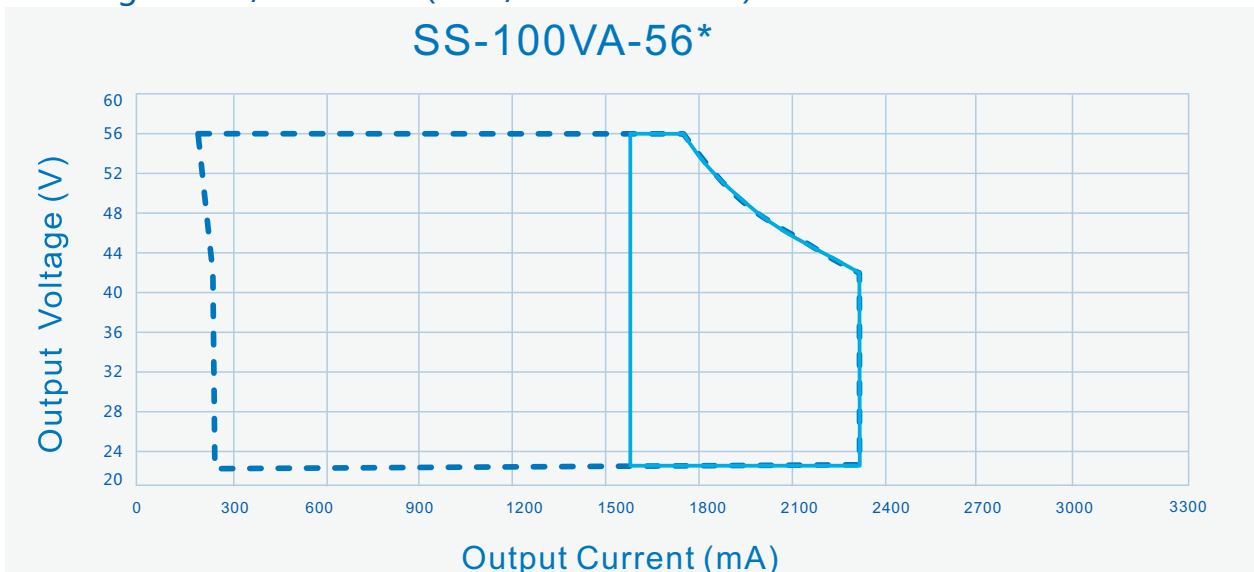

----- Dimming Window ————— AOC Window

SS-100VA Series LED Driver

Performance Curves:

Efficiency Vs. O/P Voltage ($V_{in}=120V_{ac}$)

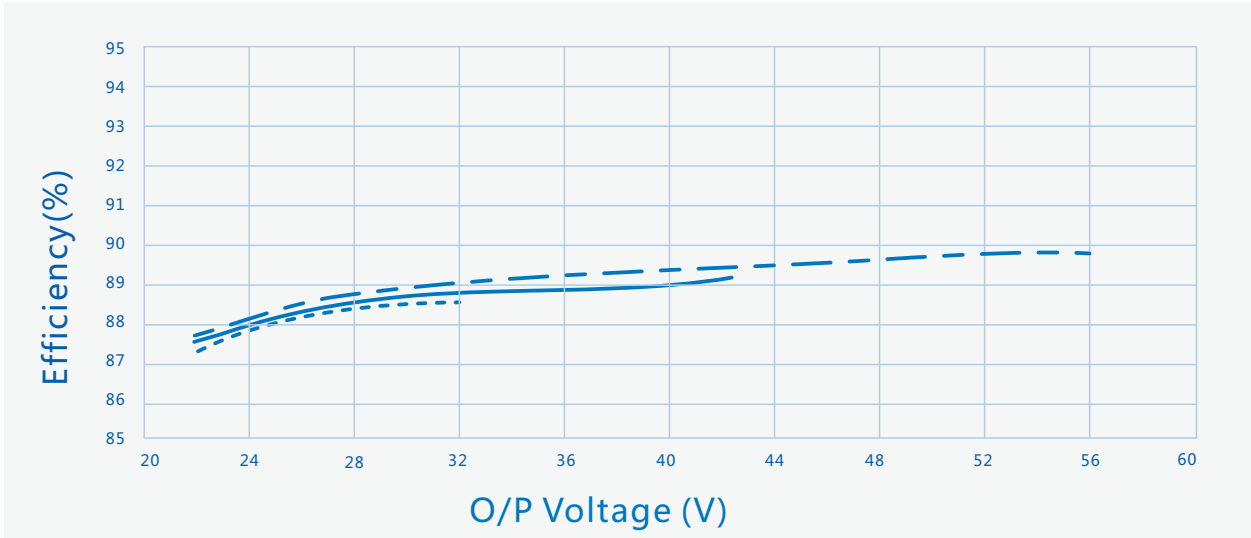

----- $I_o=3000mA$ ———— $I_o=2300mA$ - - - - $I_o=1720mA$

Efficiency Vs. O/P Voltage ($V_{in}=220V_{ac}$)

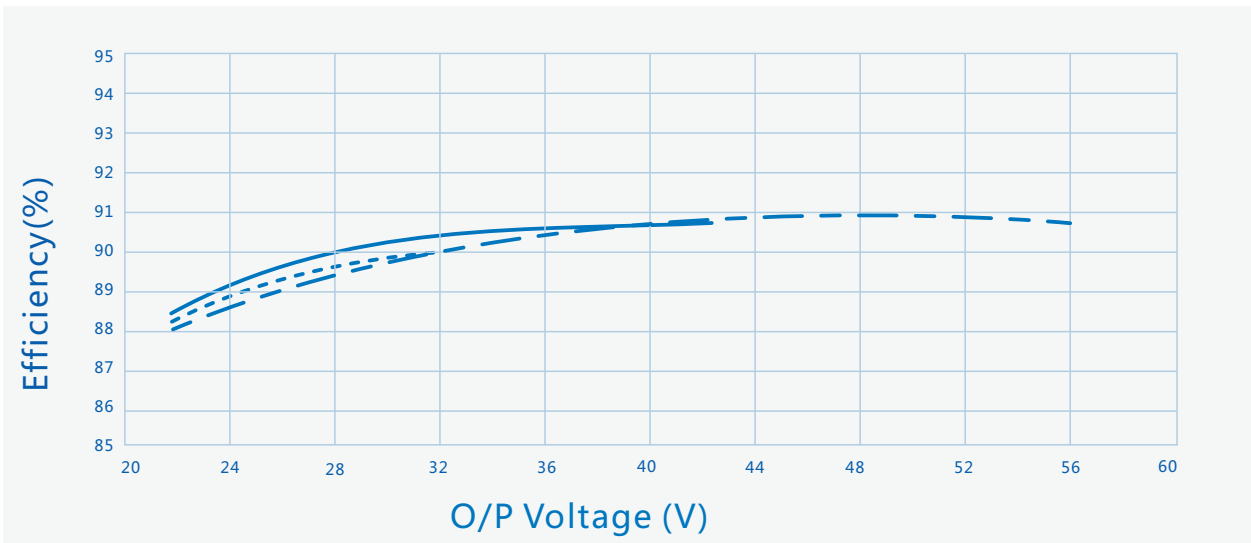

----- $I_o=3000mA$ ———— $I_o=2300mA$ - - - - $I_o=1720mA$

SS-100VA Series LED Driver

Performance Curves:

Efficiency Vs. O/P Voltage ($V_{in}=277V_{ac}$)

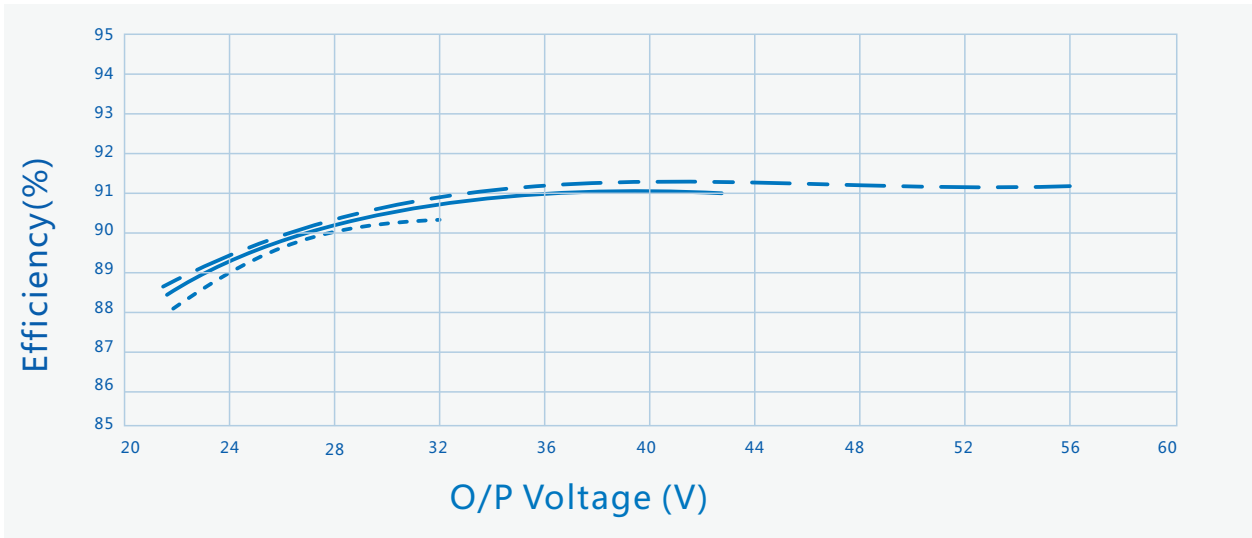

----- $I_o=3000mA$ ———— $I_o=2300mA$ - - - - $I_o=1720mA$

Power Factor Vs. O/P Power

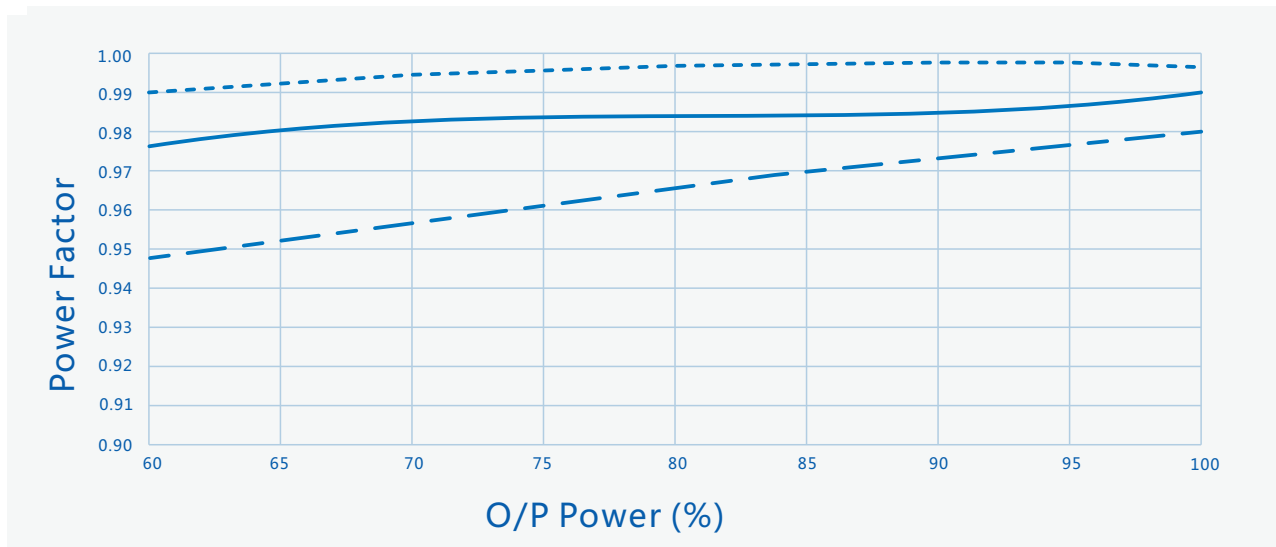

----- $V_{in}=120Vac$ ———— $V_{in}=220Vac$ - - - - $V_{in}=277Vac$

SS-100VA Series LED Driver

Performance Curves:

THD Vs. O/P Power

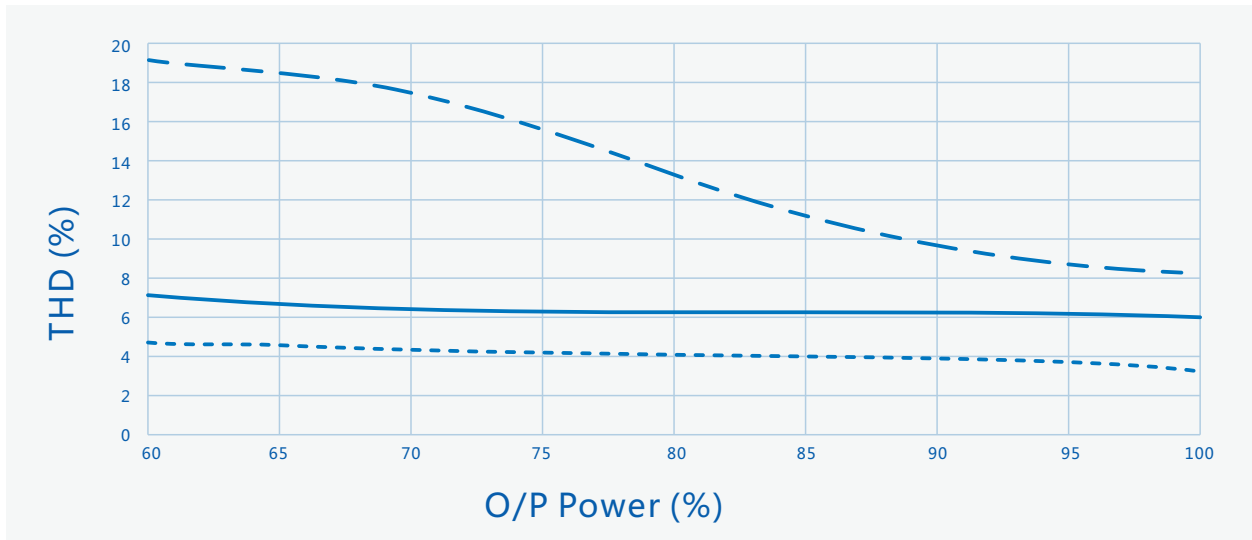

----- Vin=120Vac

———— Vin=220Vac

- - - - Vin=277Vac

SS-100VA Series LED Driver

Performance Curves:

O/P power Vs. Input Voltage
(Ta Max.60°C)

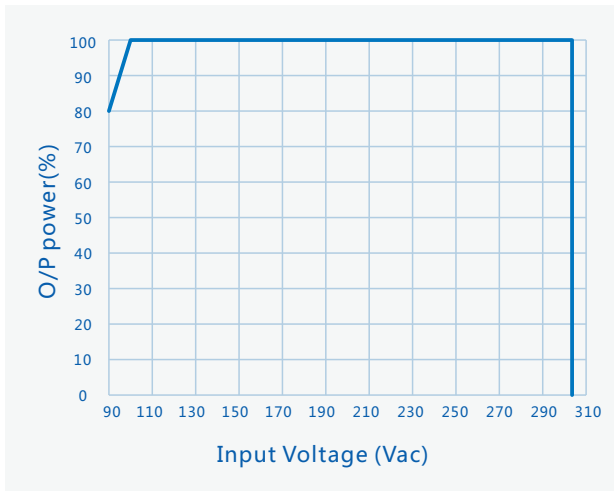

O/P power Vs. Case Temperature

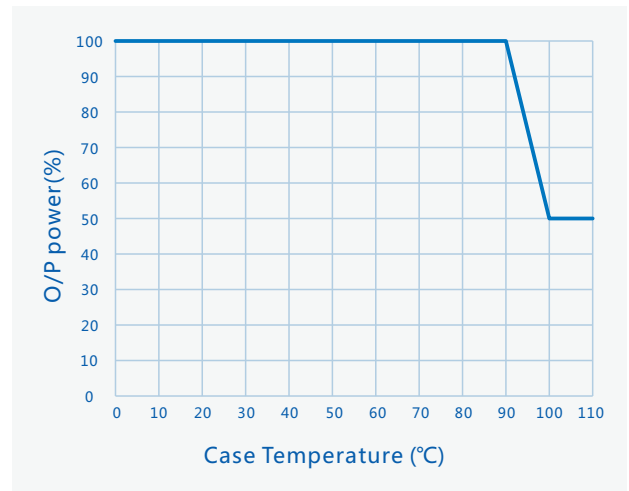

O/P Power Vs. Dimming

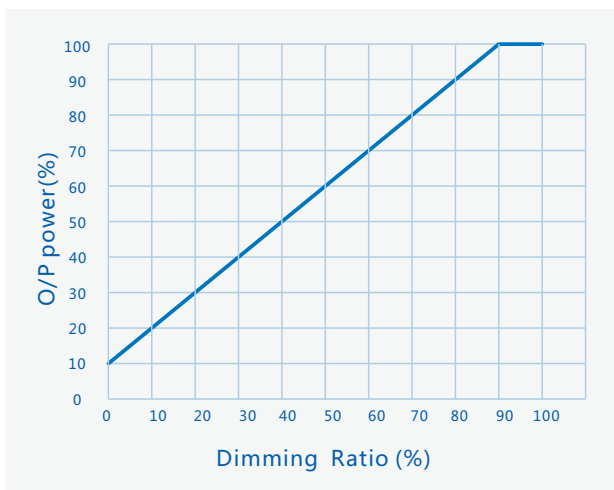

Lifetime Vs. Case Temperature

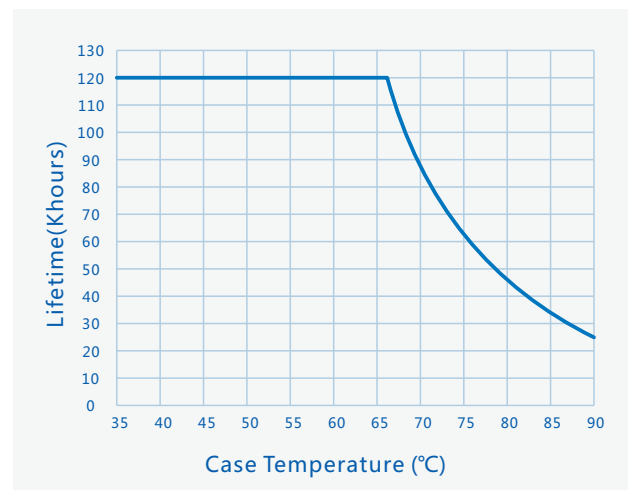

SS-100VA Series LED Driver

Timing model programming connection diagram (only for suffix "T model") :

Legacy Timer: Driver's O/P follows the pre-programmed timing curve after turn-on.

Auto-Adjust by Percentage: Driver's O/P will be adjusted by automatically changed dimming curve by the period percentage based on the latest 5 dimming curve.

Auto-Adjust by Mid-point: Driver's O/P will be adjusted by automatically changed dimming curve by mid-point based on the latest 5 dimming curve.

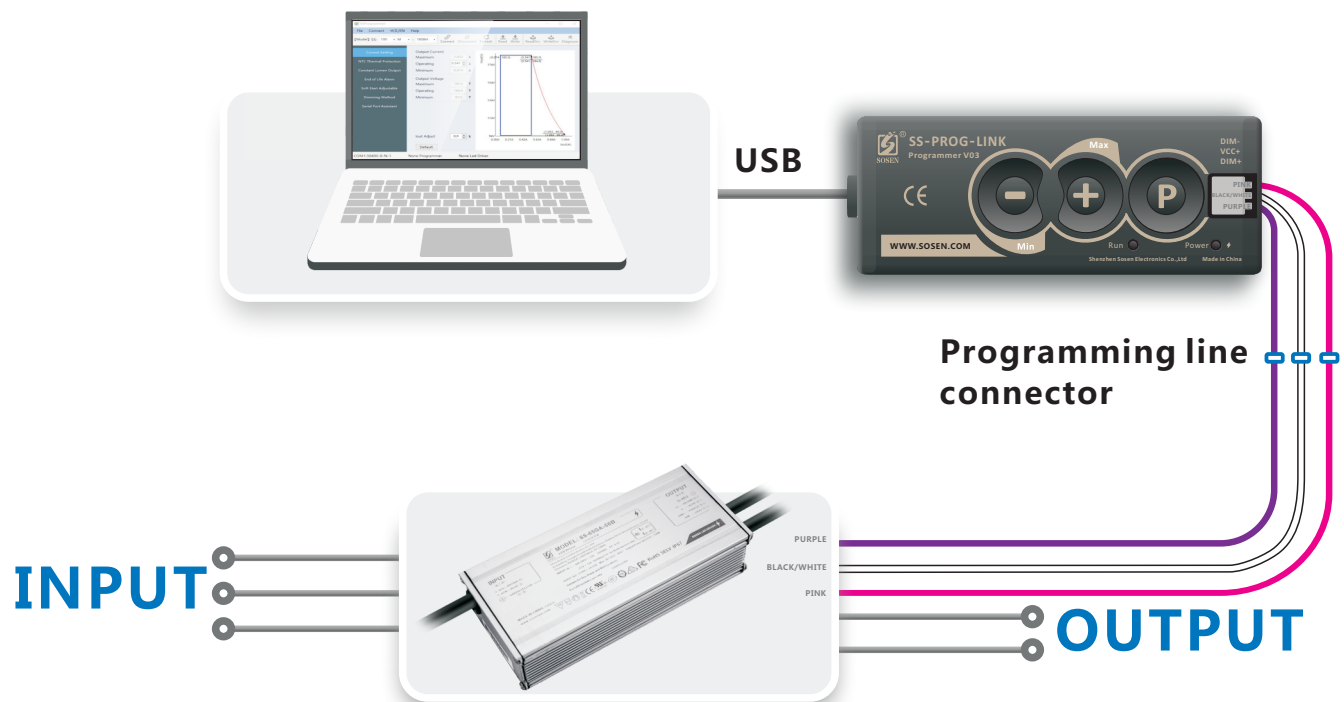

Note:

For details, please refer to the Sosen SS-PROG-LINK Programmer Manual.

SS-100VA Series LED Driver

Mechanical Characteristics

AC Input Cable(Exposed Length 450±10mm):
 UL model: SJTW,3*18AWG,O.D: 7.8mm,Black:L,White:N,Green:⊕
 Global model: SJOW,3*17AWG ,O.D:8.2mm,Brown:L, Blue:N,Yellow/Green:⊕

DC Output Cable(Exposed Length 250±10mm):
 UL model: SJTW,2*18AWG,O.D: 7.3mm,Red:V+ , Black:V-
 Global model: SJOW,2*17AWG, O.D:7.7mm, Brown:V+ , Blue:V-

DIM/Timing Cable(Exposed Length 220±10mm):
 UL/Global model(B model): STYLE 21996#22AWG , O.D: 4.7mm ,
 Purple : DIM+ , Pink: DIM-
 UL/Global model(T model): STYLE 21996#22AWG , O.D: 4.9mm ,
 Purple : PROG, Pink: GND , Black/White: VCC+

Note :

- Please follow the "LED Driver User Manual" obtained from SOSEN's official website for assembly.
- AC Input Cable,DC O/P Cable,DIM/AUX Power/Programming Cable:
 Peeled length of cable:43±5mm, Tinned length of wire:10±2mm

Name Description	Standard Code	mm(In.)
Case Length	L3	154(6.06)
Case Width	W1	66(2.6)
Case Height	H	35.5(1.4)
Overall Length	L1	179(7.05)
Mounting Hole Length	L2	164(6.46)
Mounting Hole Width	W2	32(1.26)
TC Point Position	X	57(2.24)
TC Point Position	Y	33.7(1.33)

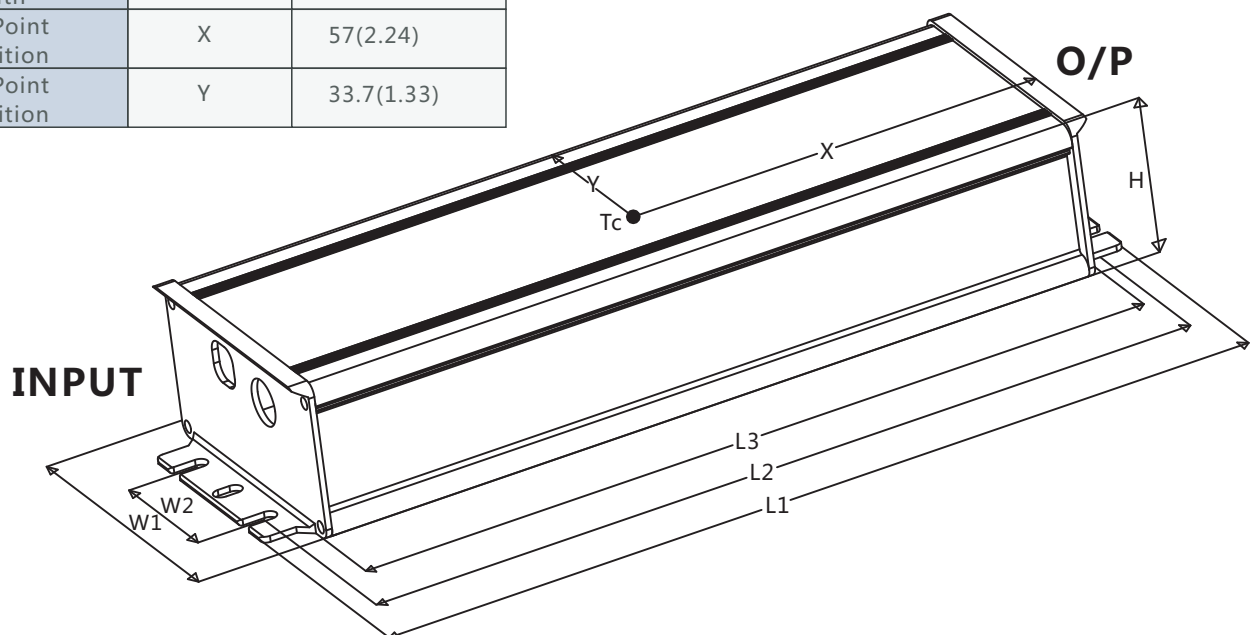

SS-100VA Series LED Driver



Assembly Tips

1. Description of current regulation for constant power models: This product is constant power, the no-load voltage changes with the O/P current; When the no-load voltage is close to the voltage of the LED lamp, the LED lamp is embedded in the voltage; the power source enters the constant voltage mode; The rate is not constant. At this time, first adjust the potentiometer counterclockwise to the minimum, and then fine-tune the potentiometer clockwise to the finger Fixed power.
2. Highly recommended to seal the adjustable hole with silicon glue(#704 preferred) after adjusting the Driver's O/P current. Torsion with proper strength to avoid permanent damage to the potentiometer inside.
3. Dimming tinned connectors should be capped if not used to avoid dimming parts damage from external signals.

Package

- Outside carton dimension: L×W×H =495mm×385mm×162mm;
- 14PCS/Carton;
- Net weight/Piece: 0.69kg;Gross weight/Carton: 10.7kg;
- Please refer to the product name, model number, manufacturer identification, QC PASS, manufacturing date on the package.

Transportation

Packaging is designed suitable for transportation by trucks, vessels and flights. The products should be avoided direct sunlight and rain, loaded/unloaded with caution.

Storage

The product storage meets the standard of the GB 3873 - 83.

Products should be rechecked if stored for over 1 year before assembly.

RoHS

Products comply with RoHS Directive (2011/65/EU) and amendment 2015/863/EU.

Revision History

Version	Description of Update	Updated Date	Remark
V00	Original Release	2018/10/18	
V01	Update Structure Diagram	2019/04/04	
V02	Update Cable Description	2019/07/04	
V03	Increase Timing Function	2020/01/08	
V04	Update Programming Diagram	2020/03/23	
V05	Update Tinned Length Of Wire	2021/07/02	
V06	Update DIM Cable Color	2021/09/02	