

COPAS 3



A Brilliant Innovation

Created With Multifamily In Mind

Thanks to a unique low profile and small aperture design, it provides you with high quality, cost effective LED lighting in practically any space. Plus, simplifies installation and maintenance and blends into any aesthetic. It's performance and value all in one compact package.



It's all in the twist

Connect LED engine and optics in a fast way

It was created to make your job easy. Its broad compatibility simplifies the specification process making installing or replacing the light and trim fast and tool-free. In addition, it is highly flexible, allowing you to vary colors and arrangements easily.

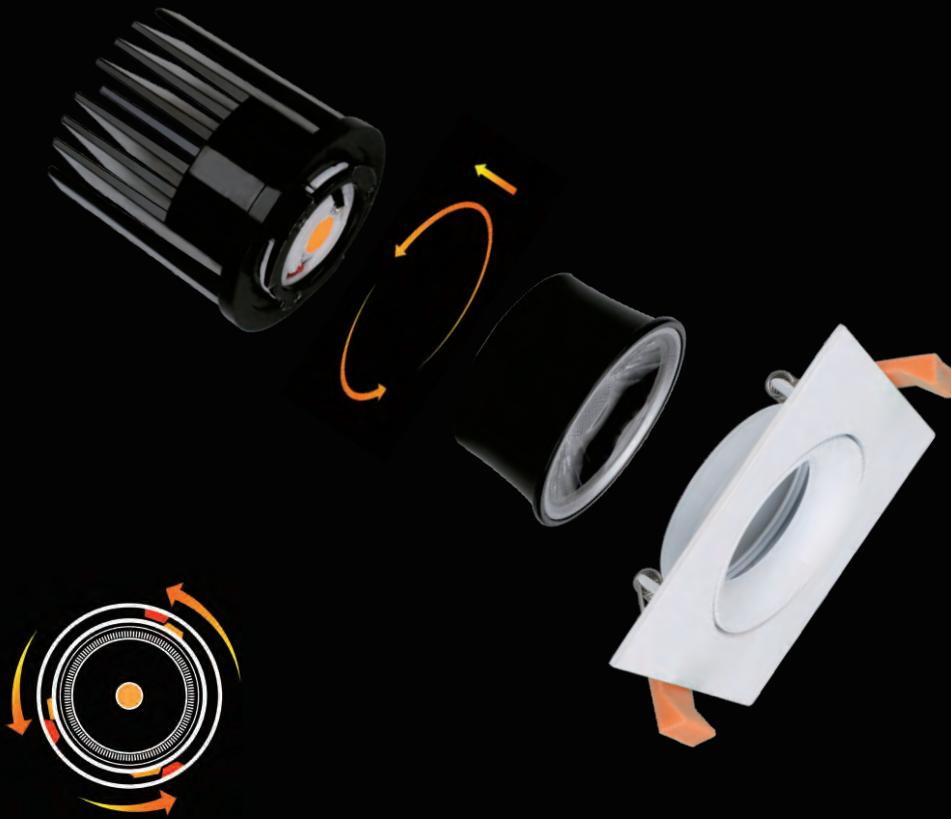

The Twist & Lock feature allows for easy, tool-free installations and seamless integration of multiple optics and trim options.

Excellence Heatsink Exceeds Expectations

18W LED engine are controlled at 70°C when it's working. The temperature will be decreased after connected with optics, as the optics is made of metal material.

It offers the lamp itself maximum space to achieve finest emitting effect. Non-parallel heat fins can create great air convection and quickly remove the heat out. The temperature of all heatsinks are controlled at 60-70°C.



LED Engine
10W / 18W Options



True color, every time

90+ CRI, produces outstanding illumination at a tight chromaticity specification and color binning process to ensure CRI and CCT consistency. It also offers an exceptionally long life and optimized form factors, as well as vivid color in a range of hues.



The Magic Of Optics

Powerful light in a compact package

There are 5 kinds of optics. All optics uses metal bracket to make sure durability and texture. The MR16 standard size(diameter 1.96")design make them widely practical. It is equipped by quick-connect structure, easy and fast to change the optic.

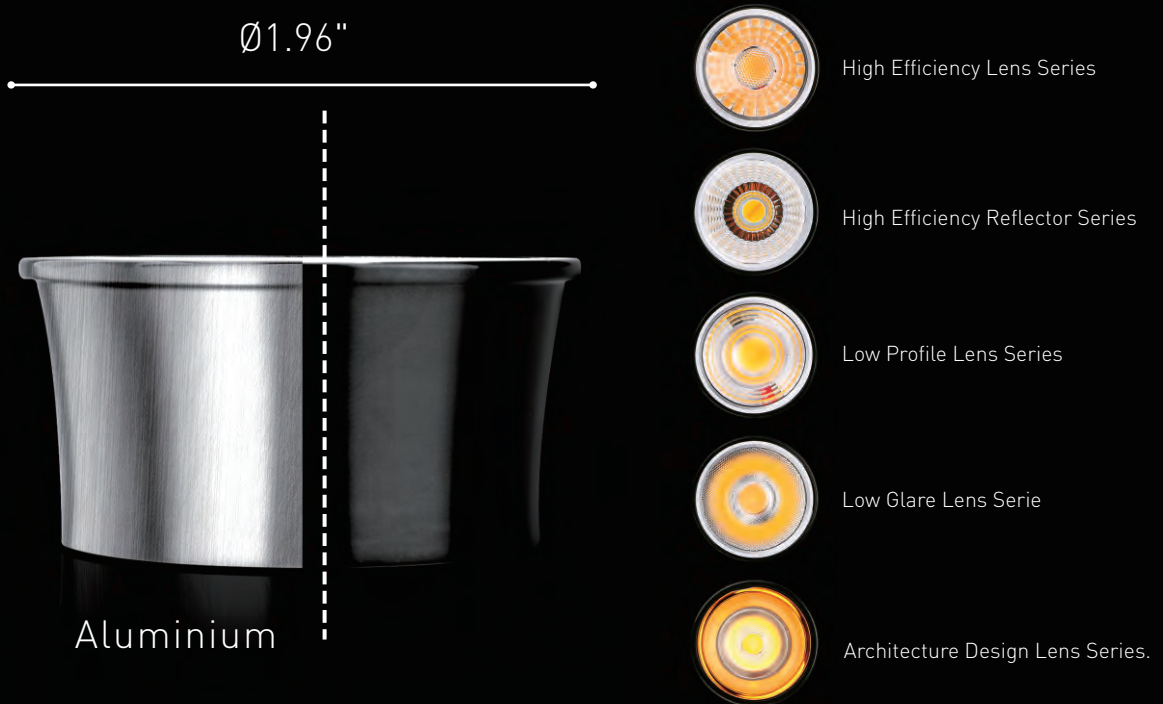

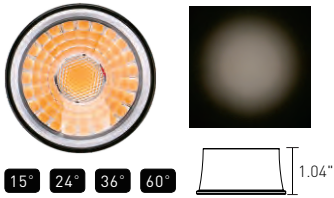

High Efficiency Lens Series

Classic reflector-like design provides high lighting transmittance. Average effect in light control and anti-glare with side facula and fade-out facula. Non-suitable in professional anti-glare luminaries.

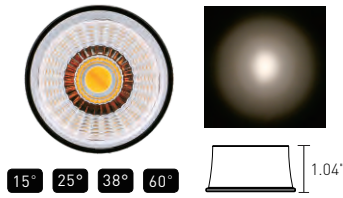

High Efficiency Reflector Series

It's similar to traditional halogen lamp finish. The reflector surface is vacuum plated aluminum which create a strong metal texture. Average effect in light control and anti-glare with strong side facula and fade-out facula. It's not suitable in professional anti-glare luminaries.

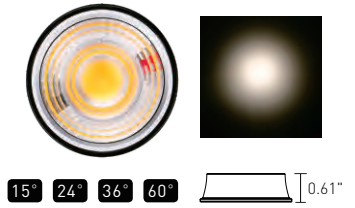

Low Profile Lens Series

It's designed with Fresnel & Calculus optical processing technology. The lens is very thin with good light control and facula effect. It has a soft facula and slight side facula which suitable to use in ultra slim luminaries.

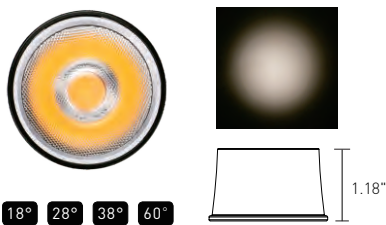

Architecture Design Lens Series

It's designed for the professional market, mainly used in high-end apartment, hotels, and clubs. It has cut-off facula and no side facula. It's suitable for professional anti-glare lamps.

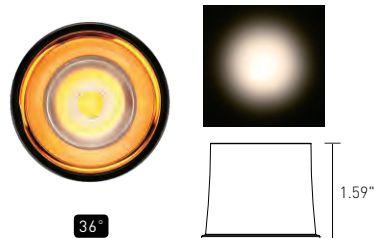

Low Glare Lens Series

It uses crossing light distribution technology which can greatly reduces the glare index. The anti-glare ring is available in 4 colors to meet the needs of different architectural styles.

Whatever your needs, there's a perfect match for your project

We offer highly customizable options for trim color, shape and mounting accessory. That means you can choose whether the fixture blends in seamlessly or provides a striking contrast.

Optional Trims



Round Trim



Adjustable Round Trim



Square Trim

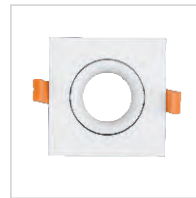

Adjustable Square Trim

Optional Accessories

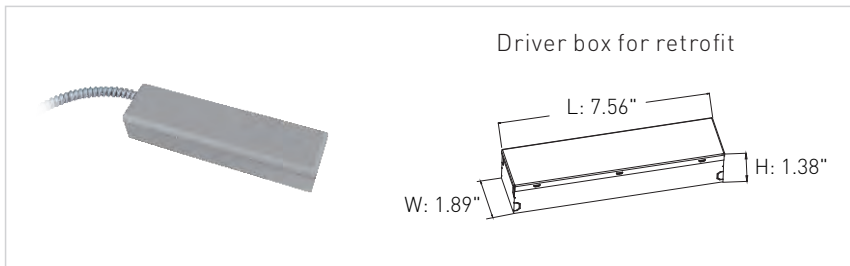
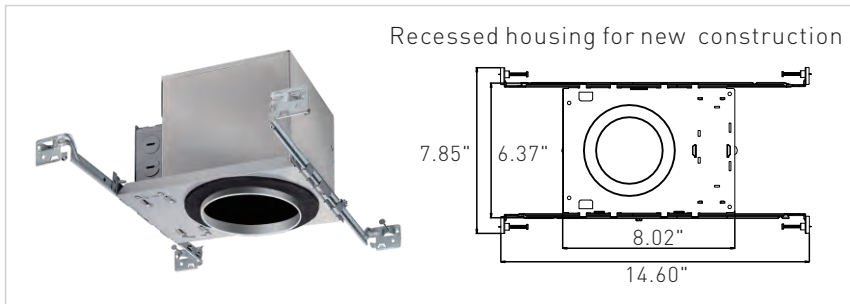



American's architectural and commercial LED Lighting Enthusiast

Founded in 2008, OKT is known for quality commercial and architectural lighting in North America. We deliver better light you can see, experience and benefit from. At OKT Lighting, our teams are made up of dreamers and doers who are committed to making better lighting. We're not only focused on making solutions that last, but on redefining what's possible, from the lighting we engineer to the value we add.

WE ARE YOUR RELIABLE PARTNER

We are your logistics hub. Our network covers entire North America.

- Shipping within 48 hours
- Without Stock Risk
- No Tariff Worries
- Live Inventory Access
- 24/7 Online Service
- Local Assembly*
- Prompt RMA
- Local OEM
- Dropship

We are your marketing dept., visual marketing support is available.

- Data Sheet
- Sales Sheet
- Installation Sheet
- IES
- Revit Files
- HD Photos
- Video
- Sample Bags
- Professional Product Training