

# ■ Bi-Level Microwave Sensor For High Bay Light BRI819-B-D Instruction



BRI819-B-D



RC-100  
(OPTIONAL)

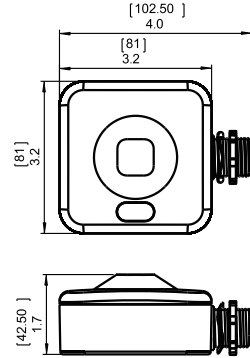

## INTRODUCTION

The BRI819-B-D mounts in an indoor lighting fixture and provides multi-level control based on motion. It controls 0-10 VDC LED drivers or dimming ballasts. All control parameters are adjustable via a wireless configuration tool capable of storing and transmitting sensor profiles.

The product is a moving object sensor for high bay installation. Its detection height is 50ft, radius is max30ft, and working frequency is 5.8GHz. The advantage of this product is stable working state (stable working temperature: -40°~+70°C).

## SPECIFICATIONS

Power supply	120/277VAC 50/60Hz
Maximum load @ -40°F ~ +158°F (-40°C ~ +70°C)	Resistive/Halogen - 800W@120V/1200W@277V Fluorescent Ballast - 660W@120V/1200W@277V Electronic Ballast (LED/CFL) - 5A@120V/5A@277V
HF System	5.8GHz CW
Dim control output	0-10V, max. 25mA sinking current
Detection radius/angle	30ft / 360°
Mounting height	Max 50ft
Time setting	10sec. - 15min.(adjustable)
Light-control	10-2000Lux (adjustable)
Humidity	Max. 95% RH
Temperature	-40°F ~ +158°F (-40°C ~ +70°C)

## ⚠ WARNING

**NOTE:** Warm up time is 15seconds. After the sensor connects input power first time, the light will keep on 15seconds, then go to dimming to work normally.

**NOTE:** Factory Default Setting: 100% sensitivity, Hold on time: 10seconds, Daylight sensor is 30lux, Dimming level:30%, Dimming time: 60minutes.

**NOTE:** Any setting changed by DIP Switch or remote control, the led light that sensor connect will on/off as confirm.

# ■ Bi-Level Microwave Sensor For High Bay Light BRI819-B-D Instruction

## SENSOR INFORMATION

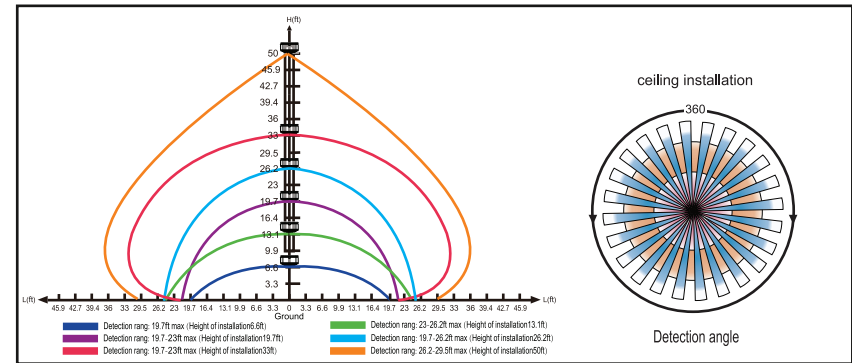

## WIRING DIAGRAMS

### Non-Dimming Driver

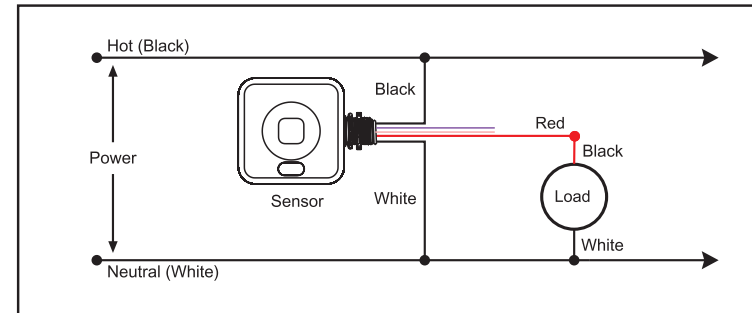

### Dimming Driver

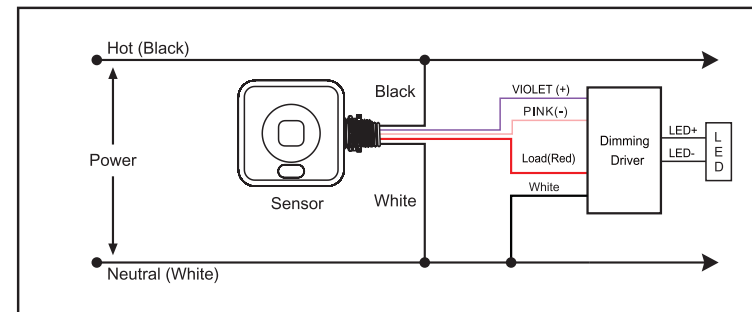

# ■ Bi-Level Microwave Sensor For High Bay Light BRI819-B-D Instruction

## FUNCTION AND OPTIONS

The microwave sensor to achieve tri-level dimming control, for some areas that require a light change notice before switch off.

It offers 3 levels of the light Control : 100%--dimming light (0,10%,30%,50%)--off;and 2 periods of selectable waiting time: motion hold-time and stand-by time. Selectable daylight threshold and choice of detection area.



With sufficient natural light, the light does not switch on when presence detected.



With insufficient natural light, the sensor switches on the light automatically when person enters room.



People left, light still dims to 0/10%/30%/50% (options) standby level after the hold time.



Light switches off automatically after after stand-by time elapsed.

## PARAMETER SETTING BY DIP SWITCH

Consider the picture: 1, 2 set sensitivity; 3, 4 set hold time; 5, 6 set the lux; 7, 8 stand-by light level ; 9, 10 set stand-by time ;

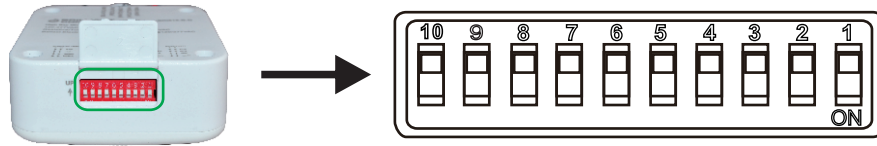

## Detection Range Setting (sensitivity)

Detection range is the term used to describe the radii of the more or less circular detection zone produced on the ground after mounting the sensor light at a height of 50ft, pull switch to the OFF position as "↑", pull switch to the ON position as "↓", switch location and detection range of the corresponding table is as follows:

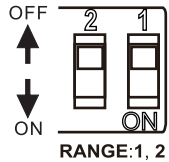

SENSITIVITY	
1	2
↑ ↑	20%
↑ ↓	50%
↓ ↑	75%
↓ ↓	100%

## Hold Time Setting

The light can be set to stay ON for any period of time between approx.10sec and a maximum of 15min. Any movement detected before this time elapse will re-start the timer. It is recommended to select the shortest time for adjusting the detection zone and for performing the walk test. Pull switch to the OFF position as "↑", pull switch to the ON position as "↓", switch location and detection range of the corresponding table is as follows:

# ■ Bi-Level Microwave Sensor For High Bay Light BRI819-B-D Instruction

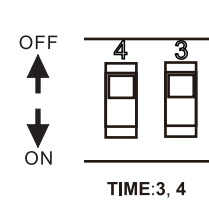

TIME	
3	4
↑ ↑	10S
↑ ↓	1Min
↓ ↑	5Min
↓ ↓	15Min

## Light-control Setting

The chosen light response threshold can be infinitely from approx. 10-50lux, pull switch to the OFF position as "↑", pull switch to the ON position as "↓", switch location and light-control of the corresponding table is as follows:

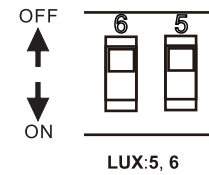

LIGHT	
5	6
↑ ↑	☀ (light sensor disable)
↑ ↓	10Lux
↓ ↑	30Lux
↓ ↓	50Lux

## Stand-by Light Level Setting

Switch to the OFF is "↑", switch to the ON is "↓"; he corresponding file of switch location and detection distance as follow:

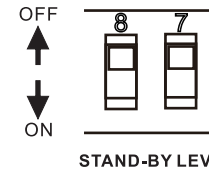

STAND-BY LEVEL	
7	8
↑ ↑	0%
↑ ↓	10%
↓ ↑	30%
↓ ↓	50%

## Stand-by Time Setting

File of switch location and detection distance as follow: file of switch location and detection distance as follow:

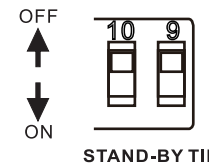

STAND-BY TIME	
9	10
↑ ↑	+∞
↑ ↓	1Min
↓ ↑	30Min
↓ ↓	60Min

## PARAMETER SETTING BY REMOTE CONTROL IN MANUAL OF RC-100.