

GLASS WALL PACK LIGHT



PRODUCT FEATURES:

- ❖ LUMILEDS LED, high luminous efficiency and long working life.
- ❖ High efficiency LED Driver, the wide range input voltage AC120-277V ;
- ❖ Cast alloy design, better cooling, light quality, LED Tj < 85°C.
- ❖ Optical design, greatly improved the light utilization and evenness
- ❖ **PHOTOCELL CONTROL (OPTIONAL)**

MODEL #	
PROJECT:	
NOTES:	
DATE:	
PREPARED BY:	

Additional Information:

- Power: 70W
- Input: AC 120-277V
- CCT : 5000K
- Output: 9380 LM
- Light Source: LUMILEDS
- Driver: WELED

Structure Features:

- Shell Material: Alloy & PC
- Color: Dark Bronze
- Weight: 9.9 lbs.



PRODUCT APPLICATIONS:

The 1000LED LED WALL PACK Lighting Series can be widely used in Pedestrian Walkways, Parking Garages, Public Areas, Schools, Hospitals, Hotels and Outdoor Walkways

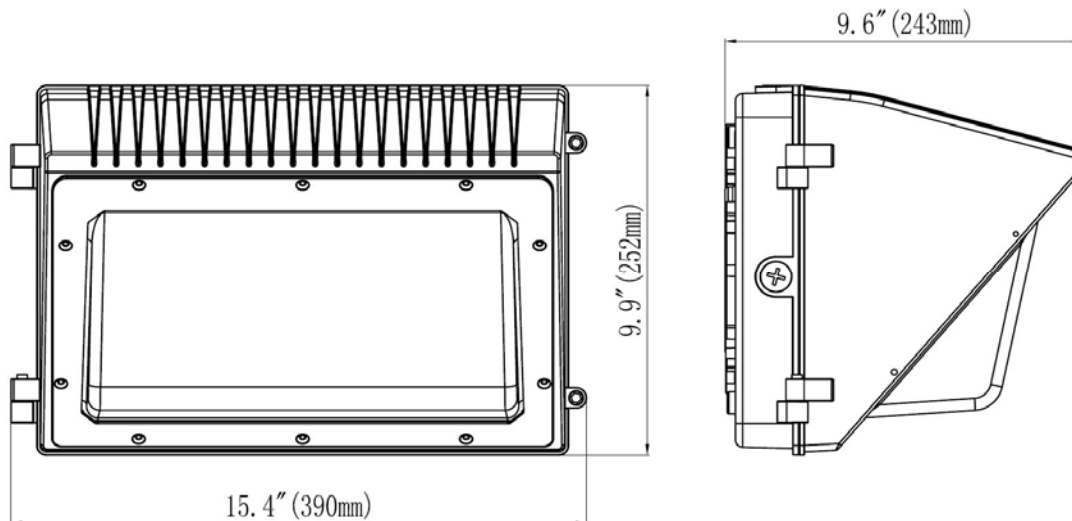

GLASS WALL PACK LIGHT

TECHNICAL PARAMETERS:

Type	1L-GWP07W27-XXK-Z-P		
Power	70W	Lighting Angle	90*120°
Input Voltage	AC120-277V	LED Brightness Decay	<5%/6000 hrs
PF	>0.95	Working Life	>50000 hrs
Driver Efficiency	>90%	Working Temperature	-30 - +45°C
Luminous Flux	9380 Lm	Storage Temperature	-40 --+80°C
Color Temperature	3000K/4000K/5000K/6500K	Protection Level	Wet Location/IP65
CRI	Ra>80	Cable	Input Connect, No Cable

LIGHT DISTRIBUTION CURVE: (Clear Lens)

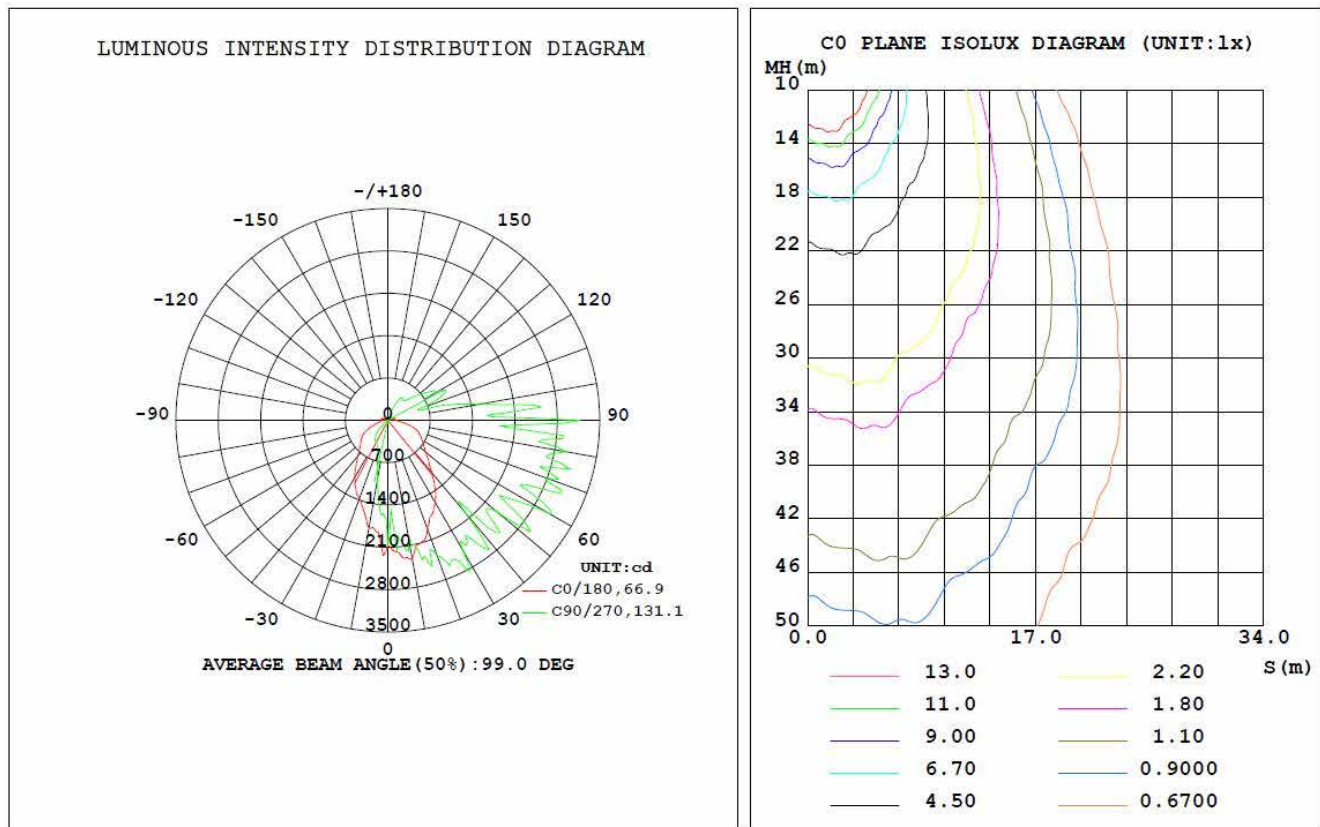

GLASS WALL PACK LIGHT

ORDERING INFORMATION:

EXAMPLE: 1L-GWP07W 27-XXK-Z-P

1L	GWP	07W	27	50K	P
Company	Product	Power	Voltage	ColorTemp	Control
1000LED	FWP Glass Wall Pack	05W (50W) 07W (70W) 10W (100W)	27 AC120-277V 48 AC200-480V	30K (3000K) 40K (4000K) 50K (5000K) 65K (6500K) ± 500K	P 100-277V PHOTOCCELL

PRODUCT CERTIFICATIONS:

