

## GLASS WALL PACK LIGHT



### PRODUCT FEATURES:

- ❖ LUMILEDS LED, high luminous efficiency and long working life.
- ❖ High efficiency LED Driver, the wide range input voltage AC120-277V ;
- ❖ Cast alloy design, better cooling, light quality, LED Tj < 85°C.
- ❖ Optical design, greatly improved the light utilization and evenness
- ❖ **PHOTOCELL CONTROL (OPTIONAL)**

MODEL #	
PROJECT:	
NOTES:	
DATE:	
PREPARED BY:	

### Additional Information:

- Power: 50W
- Input: AC 120-277V
- CCT : 5000K
- Output: 6600 LM
- Light Source: LUMILEDS
- Driver: WELED

### Structure Features:

- Shell Material: Alloy & PC
- Color: Dark Bronze
- Weight: 9.9 lbs.



### PRODUCT APPLICATIONS:

The 1000LED LED WALL PACK Lighting Series can be widely used in Pedestrian Walkways, Parking Garages, Public Areas, Schools, Hospitals, Hotels and Outdoor Walkways

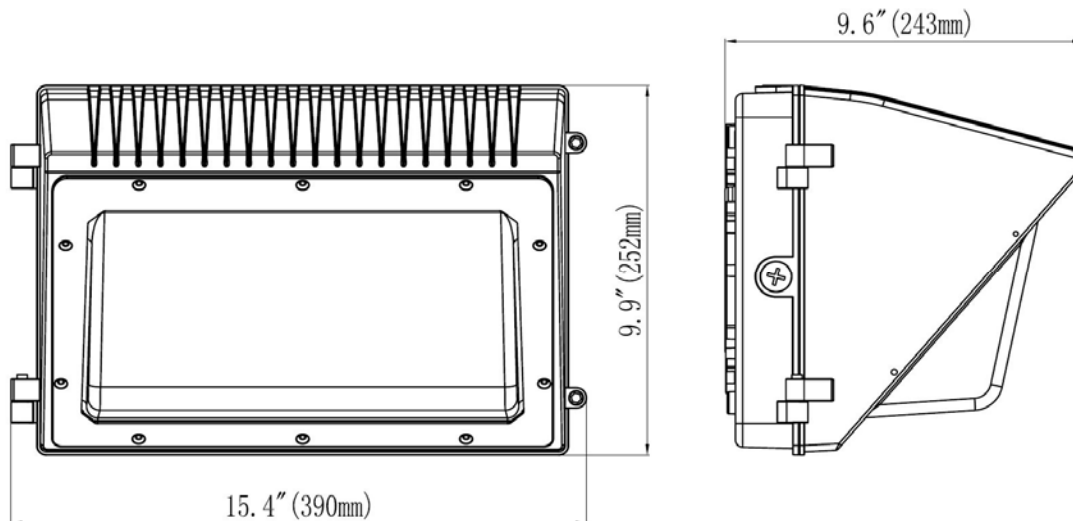

## GLASS WALL PACK LIGHT

### TECHNICAL PARAMETERS:

Type	1L-GWP05W27-XXK-Z-P		
Power	50W	Lighting Angle	90*120°
Input Voltage	AC120-277V	LED Brightness Decay	<5%/6000 hrs
PF	>0.95	Working Life	>50000 hrs
Driver Efficiency	>90%	Working Temperature	-30 - +45°C
Luminous Flux	6600 Lm	Storage Temperature	-40 --+80°C
Color Temperature	3000K/4000K/5000K/6500K	Protection Level	Wet Location/IP65
CRI	Ra>80	Cable	Input Connect, No Cable

### LIGHT DISTRIBUTION CURVE: (Clear Lens)

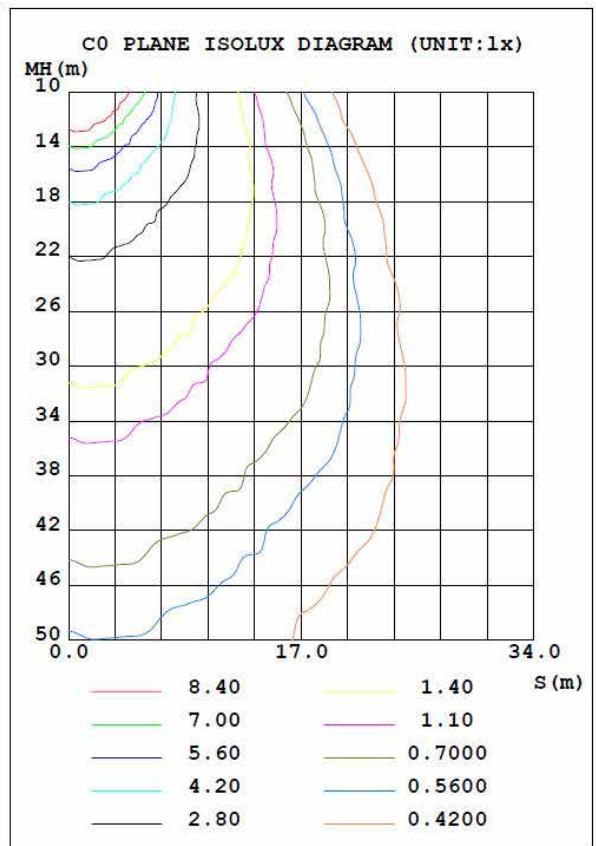
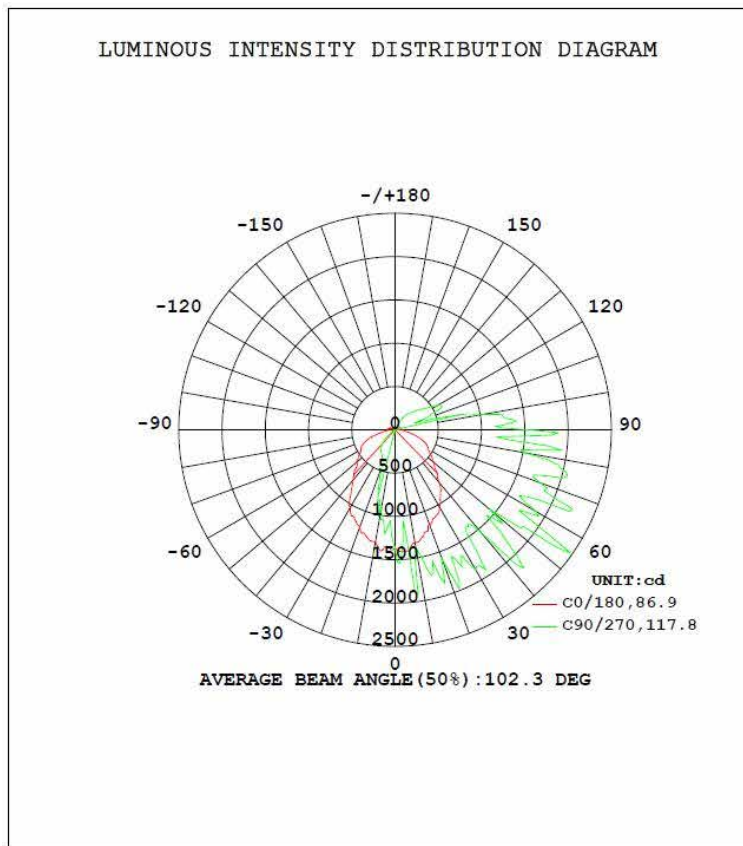

## GLASS WALL PACK LIGHT

### ORDERING INFORMATION:

**EXAMPLE: 1L-GWP05W 27-XXK-Z-P**

1L	GWP	05W	27	50K	P
Company	Product	Power	Voltage	ColorTemp	Control
<b>1000LED</b>	<b>FWP</b> Glass Wall Pack	<b>05W</b> (50W) <b>07W</b> (70W) <b>10W</b> (100W)	<b>27</b> AC120-277V <b>48</b> AC200-480V	<b>30K</b> (3000K) <b>40K</b> (4000K) <b>50K</b> (5000K) <b>65K</b> (6500K) <b>± 500K</b>	<b>P</b> 100-277V PHOTOCCELL

### PRODUCT CERTIFICATIONS:

