

**Wattages: 45W, 70W / Tunable Wattages: 30W/45W/60W/70W**

Tunable LED Full Cut-Off Wall Pack series can be widely used indoor or outdoor (wet location). Ideal for mechanical or electronic workshops, storage warehouses, steel mills, gas stations, toll booths, railway platforms and much more.



**WATT/CCT**  
**FIELD-ADJUSTABLE**

## FEATURES

- Lumileds LED, high luminous efficiency and long working life.
- High efficiency LED Driver, the wide range input voltage AC120-277V/AC 347V.
- Excellent optics design, greatly improve the light utilization and evenness.
- Motion sensor control available (Optional)
- 1-10V Dimming.

Die-cast aluminum cooling design, high quality and better cooling for LED Tj < 85°C.



SPECIFICATION			
WATTAGE	45W	70W	30W/45W/60W/70W
LUMEN	6756 lm	10500 lm	4216 / 6139 / 7882 / 8980 lm
EFFICACY	150 lm/W	150 lm/W	130 lm/W
CCT	4000K, 5000K		3000K/4000K/5000K
CRI	70		70
INPUT VOLTAGE	120-277V / 347V	120-277V	120-277V
POWER FACTOR	0.95		0.95
DRIVER EFFICACY	90%		90%
DIMMING	1-10V Dimming		1-10V Dimming
LIGHT ANGLE	82° X 102°		
LIFE SPAN	75,000 hrs		
WORKING TEMPERATURE	-22°F ~ 113°F		
STORAGE TEMPERATURE	-40°F ~ 176°F		
OUTDOOR RATING	Wet location		
CABLE	Input Connect, No cable		
WARRANTY	5 year limited		

**Wattages: 45W, 70W / Tunable Wattages: 30W/45W/60W/70W**

### DIMENSION

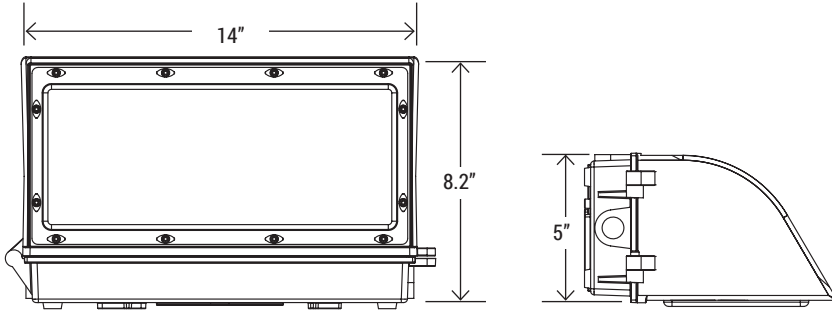

<b>WATTAGE</b>	45W
<b>NT. WEIGHT</b>	6.4 lbs/carton
<b>BOX DIM.</b>	14" x 8.2" x 5"

<b>WATTAGE</b>	70W
<b>NT. WEIGHT</b>	6.61 lbs/carton
<b>BOX DIM.</b>	14" x 8.2" x 5"

<b>WATTAGE</b>	30W/45W/60W/70W
<b>NT. WEIGHT</b>	6.26 lbs/carton
<b>BOX DIM.</b>	14" x 8.2" x 5"

### EMERGENCY BACK-UP (SOLD SEPARATELY)



**BLD-CM20N-480800-8W**  
8W Emergency Backup Battery  
LED Driver

**BLD-CM20N-480800-15W**  
15W Emergency Backup Battery  
LED Driver

**BLD-CM20N-480800-20W**  
20W Emergency Backup Battery  
LED Driver

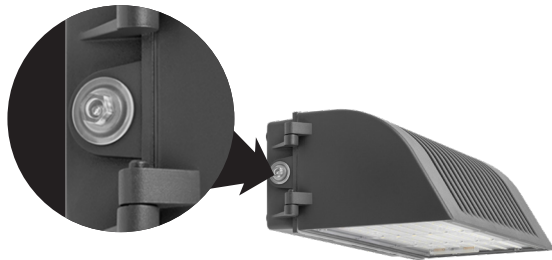

**CONTROLS (SOLD SEPARATELY)**  
P (Photocell)



**WATT/CCT**  
**FIELD-ADJUSTABLE**

### ORDERING INFORMATION

EXAMPLE:

**1L-FWP-07W-27-50K-P**

1L	FWP	07W	27	50K	D	P
COMPANY	PRODUCT	WATTAGE	VOLTAGE	CCT	FINISH	CONTROL
1000 LED INC	<b>FWP</b> Full Cut-Off Wall Pack	<b>*45W</b> - (45W) <b>07W</b> - (70W)  <b>34567W</b> - (30W/45W/ 60W/70W)	<b>27</b> (AC120-277V) <b>*347</b> (AC347V)	<b>40K</b> - (4000K) <b>50K</b> - (5000K)  <b>345K</b> - (3000K/4000K/5000K)	<b>D</b> - (Dark Bronze) <b>W</b> - (White) <b>B</b> - (Black) <b>S</b> - (Silver)	<b>P</b> - (Photocell)

Wattages: 45W, 70W / Tunable Wattages: 30W/45W/60W/70W

## PHOTOMETRICS

For complete IES files, please visit our website.

### IL-FWP-45W-50K

LUMINOUS INTENSITY DISTRIBUTION DIAGRAM

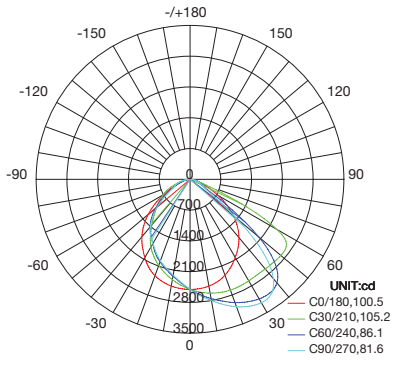

AVERAGE BEAM ANGLE(50%): 93.4 DEG

C0 PLANE ISOLUX DIAGRAM (UNIT:lx)

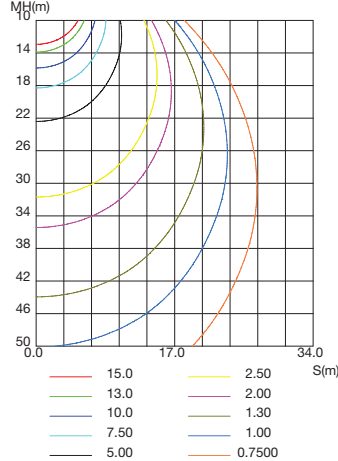

ISOLUX DIAGRAM

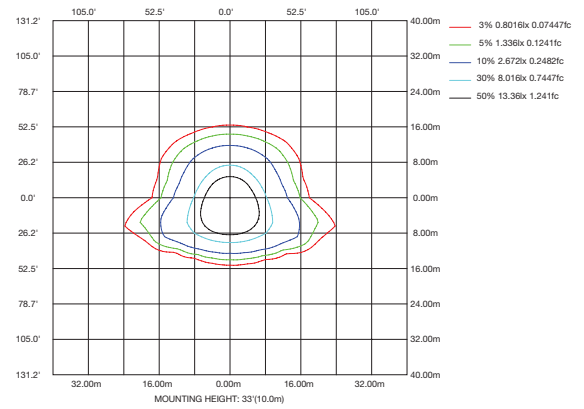

### IL-FWP-70W-50K

LUMINOUS INTENSITY DISTRIBUTION DIAGRAM

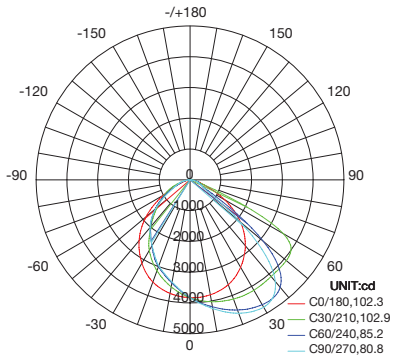

AVERAGE BEAM ANGLE(50%): 92.8 DEG

C0 PLANE ISOLUX DIAGRAM (UNIT:lx)

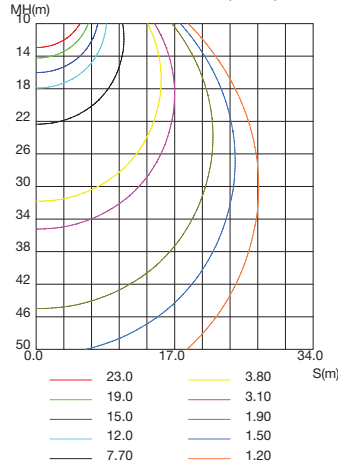

ISOLUX DIAGRAM

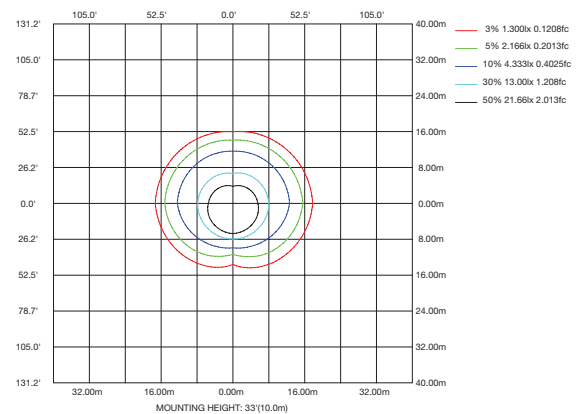

### IL-FWP-34567W-50K (SHOWN IS 70W@5000 K)

LUMINOUS INTENSITY DISTRIBUTION DIAGRAM

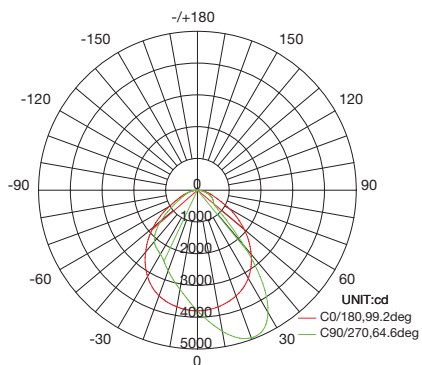

AVERAGE BEAM ANGLE(50%):81.9 DEG

C0 PLANE ISOLUX DIAGRAM (UNIT:lx)

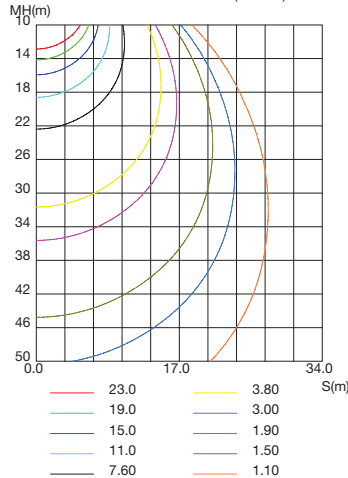

ISOLUX DIAGRAM

