

optotec CODC2

Compact splice closures

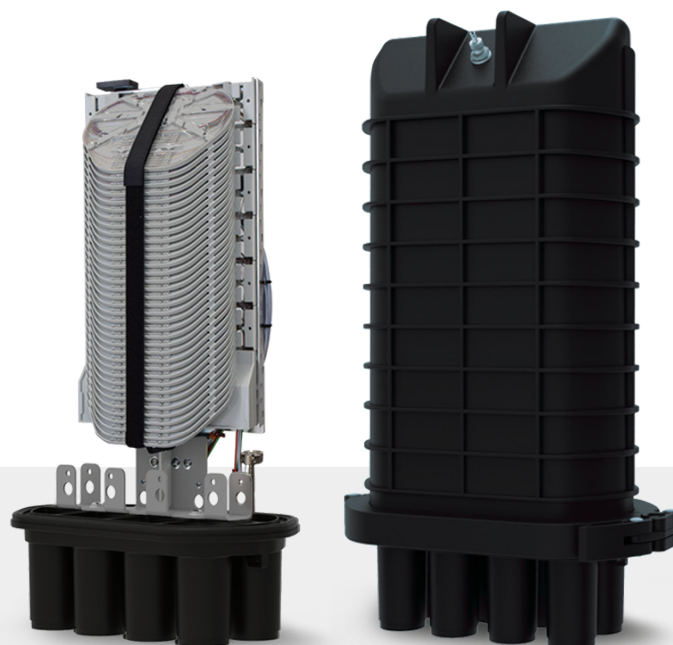

Compact CODC2 closures is a family of watertight IP68 (IEC 529) enclosures suitable for traditional cables and micro-cables, both G652 and G657 fibers.

Their flat design and compact dimensions make them suitable for installation in tight manholes and handholes, as well for network deployment on poles.

The CODC2 closures share all the SAMX cassettes module and sealing kits with the ODC2 closure family, allowing a simple, intelligent management of our customers' stocks.

A STACK is used inside to fix SAMX splicing modules on one side only. The other side is used to store the midspan looped modules. The closures are equipped with a locking system consisting of a CLAMP and a specific O-ring which guarantees the seal.

All Optotec closures have an RFID system and QR code installation instructions.

APPLICATIONS

- Butt-end closures for trunk, branch and pot-head joints
- Underground networks
- Aerial networks: on pole

INSTALLATIONS

- Handholes, manholes and chambers
- Poles
- Pot-head

KEY FEATURES AND BENEFITS

- High quality thermoplastic material - watertight
- BASE and DOME (IP68, IEC 529) with clamp and O-ring closing system
- Management capability of various types of tube cables, slotted core and ribbon
- Equipped with a clamp system to seal the BASE to the DOME
- Dedicated area for midspan cable modules (loop cable)
- Internal STACK can be configurable with SAMX HD modules according to splice needs
- BASE is suitable for both the heat-shrinking sealing kit and cold sealing kit

COMPONENTS AND CONFIGURATIONS

DIMENSIONS WITH

DOME A

HEIGHT 380 mm
WIDTH 240 mm
DEPTH 138 mm

DOME B

HEIGHT 450 mm
WIDTH 240 mm
DEPTH 138 mm

Clamp



DIMENSIONS

WIDTH 287 mm
DEPTH 155 mm



CONFIGURATIONS WITH WAPX

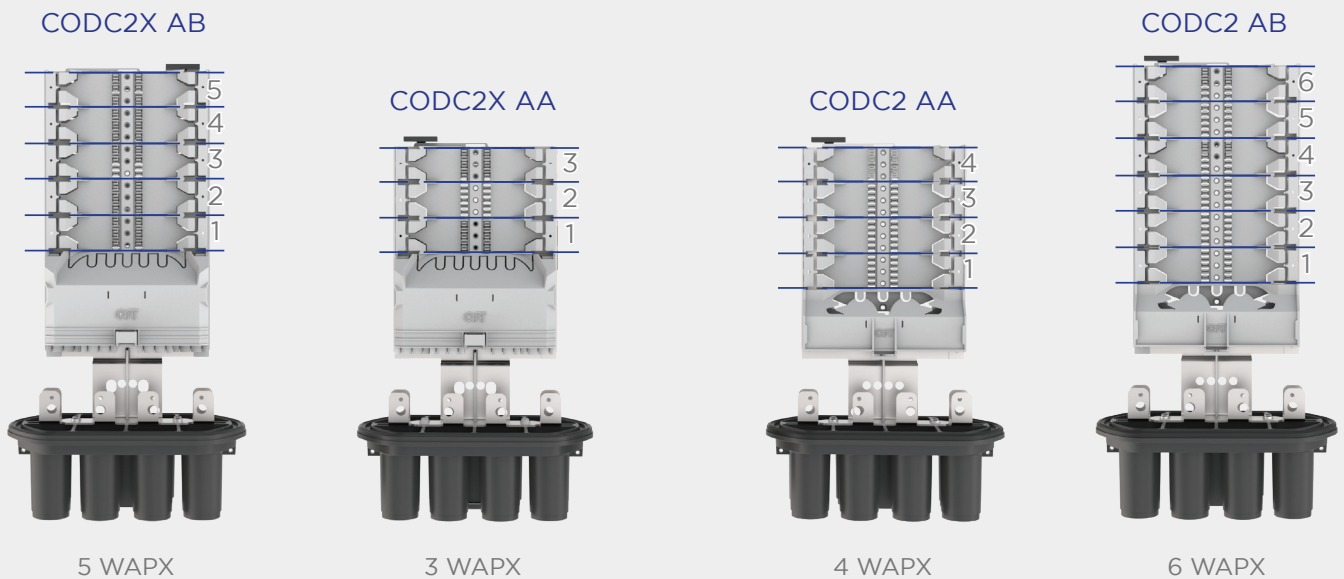

PACKAGING

PRODUCT NAME	PACKAGING TYPE	DIMENSIONS (MM)			GROSS WEIGHT (KG.)
		WIDTH	DEPTH	HEIGHT	
CODC2X-AA	Carton Box	300	170	400	~2.5
CODC2X-AB	Carton Box	300	170	470	~3
CODC2-AA	Carton Box	300	170	400	~2.5
CODC2-AB	Carton Box	300	170	470	~3

The information given herein, including the drawings, illustrations and schematics are intended for illustration purposes only and is believed reliable. However, STL makes no warranties to its accuracy or completeness and disclaims any liability in connection with its use. The obligations of STL shall be only set forth in STL's standard terms and conditions of sale and in no case shall STL be liable for any incidental, indirect or consequential damages arising from the sale, resale, use or misuse of the product.

Users of STL products should make their own evaluation to determine the suitability of each product for the specific application.

... AND MANY MORE FEATURES!

- 1 CODC2X: very large storage area for cable module entries and inversion. Suitable for managing a large amount of modules and cables (distribution closures)
- 2 CODC2: increased splice capacity suitable for high count fiber cable modules and TRUNK joints.
- 3 Ample storage area for midspan teeder tubes on the back of the stack
- 4 Simple Velcro belt makes the tubes easy to store, speeds up installation and protects the installer's work

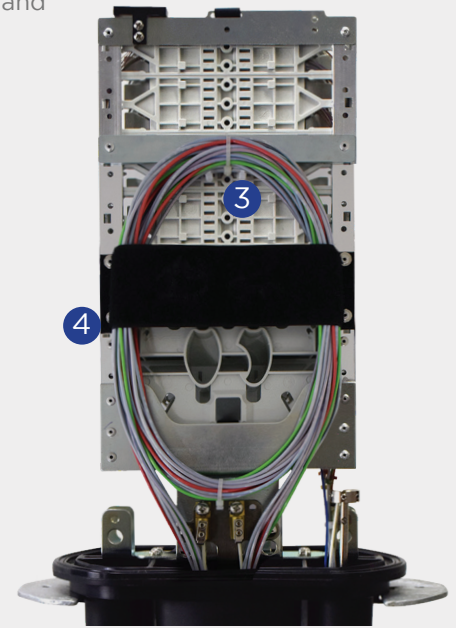
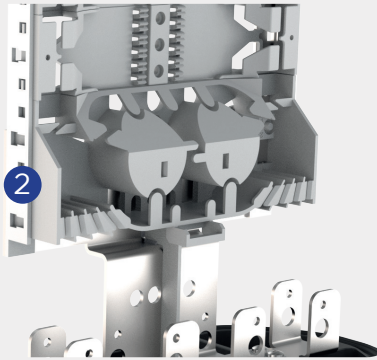
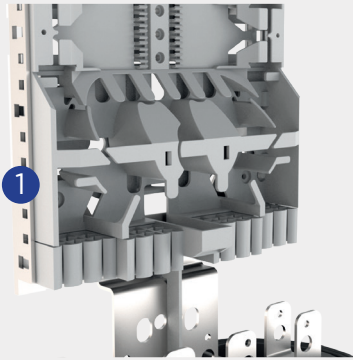

- 5 RFID NFC tag for data storage, readable even when the closure is closed. Write/read with free apps available on iOS and Android
- 6 Impossible to lose QR code installation instructions upgradable remotely, eco-friendly

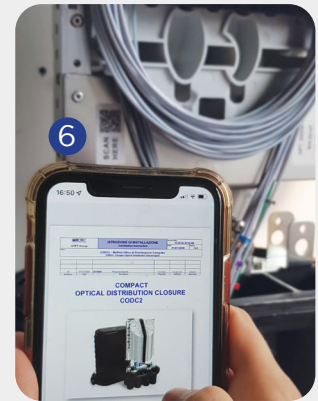
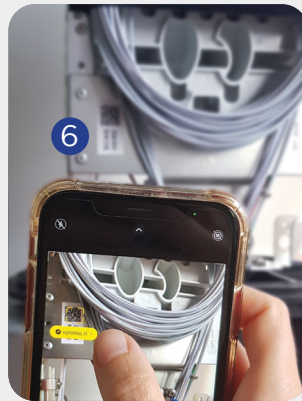
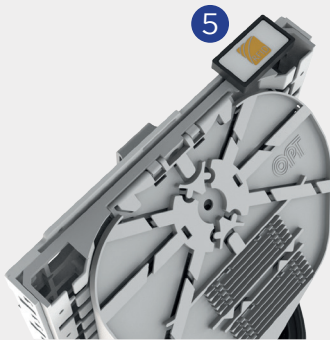

- 7 Lockable clamp for more security in the field



The information given herein, including the drawings, illustrations and schematics are intended for illustration purposes only and is believed reliable. However, STL makes no warranties to its accuracy or completeness and disclaims any liability in connection with its use. The obligations of STL shall be only set forth in STL's standard terms and conditions of sale and in no case shall STL be liable for any incidental, indirect or consequential damages arising from the sale, resale, use or misuse of the product.

Users of STL products should make their own evaluation to determine the suitability of each product for the specific application.



GUIDE TO SPLICE

TECHNICAL FEATURES

- Loop-Back ability: Yes
- Material: ABS-PC
- Flammability Rating: UL-94 V0
- Colour*: RAL 7035

*other colours available upon request



FIBERTERM SPLICE

MODULE TYPE SAMX	TRAY PER PACK	SPLICES PER TRAY	TOTAL NUM. SPLICES PER MODULE
HD6-8H 	6	8H	48
HD6-12H 	6	12H	72

APPLICATION

- Fiber management inside OPTOTEC products
- Hold and protect the splice



FIBERCLIP SPLICE

MODULE TYPE SAMX	TRAY PER PACK	SPLICES PER TRAY	TOTAL NUM. SPLICES PER MODULE
HD4-12C 	4	12C	48
HD6-12C 	6	12C	72

FIBERTERM SPLICE-ARRANGED ON 3 LAYERS

MODULE TYPE SAMX	TRAY PER PACK	SPLICES PER TRAY ARRANGED ON LAYERS	TOTAL NUM. SPLICES PER MODULE
HD3-24H 	3	≡ 3 LAYERS (8+8+8) total. 24H	72

FIBERTERM SPLICE-ARRANGED ON 2 LAYERS







MODULE TYPE SAMX	TRAY PER PACK	SPLICES PER TRAY ARRANGED ON LAYERS	TOTAL NUM. SPLICES PER MODULE
HD4-12H 	4	= 2 LAYERS (6+6) total. 12H	48
HD4-24H 	4	= 2 LAYERS (12+12) total. 24H	96

The information given herein, including the drawings, illustrations and schematics are intended for illustration purposes only and is believed reliable. However, STL makes no warranties to its accuracy or completeness and disclaims any liability in connection with its use. The obligations of STL shall be only set forth in STL's standard terms and conditions of sale and in no case shall STL be liable for any incidental, indirect or consequential damages arising from the sale, resale, use or misuse of the product.

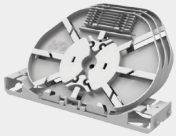
Users of STL products should make their own evaluation to determine the suitability of each product for the specific application.

GUIDE TO SPLICE

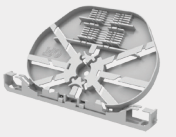
FIBERTERM SPLICE AND PLC SPLITTER

MODULE TYPE SAMX	TRAY PER PACK	SPLICES PER TRAY	TOTAL NUM. PLC PER MODULE	HELD SPLITTER SIZES	TOTAL NUM. SPLICES PER MODULE
HD3-18H-1PLC 	3	 3 LAYERS (6+6+6) total 18H	3	4x7x50 mm	54
HD1-18H-1PLC 	1	 3 LAYERS (6+6+6) total 18H	1	4x7x50 mm	18
HD4-12H-2PLC 	4	 2 LAYERS (6+6) total 12H	8	4x7x50 mm and 4x4x40mm	48
HD1-12C-2PLC 	1	 1 LAYER (6+6) total 12C	2	4x7x50 mm	12
HD3-12C-2PLC 	3	 1 LAYER (6+6) total 12C	6	4x7x50 mm	36

COMPATIBLE BARE FIBER SPLITTER SIZES

4x4x40 mm (type n:2, n:4, n:8)



7x4x50 mm (type n:16 and n:32)

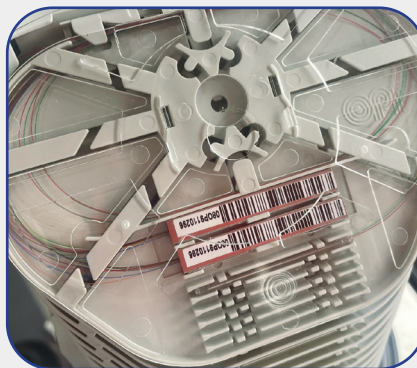

The information given herein, including the drawings, illustrations and schematics are intended for illustration purposes only and is believed reliable. However, STL makes no warranties to its accuracy or completeness and disclaims any liability in connection with its use. The obligations of STL shall be only set forth in STL's standard terms and conditions of sale and in no case shall STL be liable for any incidental, indirect or consequential damages arising from the sale, resale, use or misuse of the product.

Users of STL products should make their own evaluation to determine the suitability of each product for the specific application.

GUIDE TO COLD SEALING CCSO-CCSR ODCKIT

KIT CODE AND PICTURE	SEALING TYPE	CABLE MANAGEMENT CAPACITY		USE ON BASE
		MAX CABLES No.	CABLE TYPE AND RANGE MIN-MAX	TYPE A
ODCKIT-CCSO-2x20 	OVAL COLD SEALING	2	 10 - 20 mm	 1 KIT maximum
ODCKIT-CCSO-2x14 	OVAL COLD SEALING	2	 10 - 14 mm	 1 KIT maximum
ODCKIT-CCSO-4x10 	OVAL COLD SEALING	4	 5 - 10 mm	 1 KIT maximum
ODCKIT-CCSR-1x20 	ROUND COLD SEALING	1	 12 - 20 mm	 6 KIT maximum
ODCKIT-CCSR-1x14 	ROUND COLD SEALING	1	 10 - 14 mm	 6 KIT maximum
ODCKIT-CCSR-2x12 	ROUND COLD SEALING	2	 8 - 12 mm	 6 KIT maximum
ODCKIT-CCSR-4x10 	ROUND COLD SEALING	4	 7 - 10 mm	 6 KIT maximum
ODCKIT-CCSR-6x8.6 	ROUND COLD SEALING QUICK-LOCK	6	 7 - 8.6 mm	 6 KIT maximum
ODCKIT-CCSR-6x8 	ROUND COLD SEALING	6	 6 - 8 mm	 6 KIT maximum
ODCKIT-CCSR-8x6 	ROUND COLD SEALING	8	 4-6.4 mm	 6 KIT maximum
ODCKIT-CCSR-8x4 	ROUND COLD SEALING	8	 3 - 5.5 mm	 6 KIT maximum
ODCKIT-CCSR-16x3 	ROUND COLD SEALING	16	 0-3 mm	 6 KIT maximum
ODCKIT-CCSR-4XR95 	ROUND COLD SEALING	4	 8.5-7 mm 5-4 mm	 6 KIT maximum

The information given herein, including the drawings, illustrations and schematics are intended for illustration purposes only and is believed reliable. However, STL makes no warranties to its accuracy or completeness and disclaims any liability in connection with its use. The obligations of STL shall be only set forth in STL's standard terms and conditions of sale and in no case shall STL be liable for any incidental, indirect or consequential damages arising from the sale, resale, use or misuse of the product.

Users of STL products should make their own evaluation to determine the suitability of each product for the specific application.





GUIDE TO HEAT-SHRINK SEALINGS ODCKIT

KIT CODE AND IMAGE	SEALING TYPE	CABLE MANAGEMENT CAPACITY		USE ON BASE
		MAX CABLES NO.	CABLE Ø RANGE MIN-MAX	TYPE A 
ODCKIT-OVAL PORT SEAL LT 	HEAT-SHRINK OVAL SEALING	2	14 - 25mm	✓ 1 KIT MAXIMUM
ODCKIT-ROUND PORT A SEAL LT 	HEAT-SHRINK ROUND SEALING	1	14 - 28mm	✓ 6 KITS MAXIMUM
ODCKIT-ROUND PORT SEAL LT EXT 	HEAT-SHRINK ROUND SEALING	1	8 - 28mm	✓ 6 KITS MAXIMUM
ODCKIT-DROP WITH ONE MORE CABLE ENTRY 	HEAT-SHRINK SEALING AND SECOND CABLE CONFIGURATION ROUND A	1 (2)	6 - 14mm	✓ 6 KITS MAXIMUM
ODCKIT-2° ADDED DROP CABLE ENTRY 	HEAT-SHRINK SEALING AND SECOND CABLE CONFIGURATION ROUND A	1	6 - 14mm	✓ 6 KITS MAXIMUM
ODCKIT-TAP 	ARMOURED CABLES GROUND FEED-THROUGH			✓
ODCKIT-OPS-CC 	OVAL HEAT-SHRINK SEALING FOR SLOTTED CORE CABLES			✓
ODCKIT-RPS-CC 	ROUND HEAT-SHRINK SEALING FOR SLOTTED CORE CABLES			✓

The information given herein, including the drawings, illustrations and schematics are intended for illustration purposes only and is believed reliable. However, STL makes no warranties to its accuracy or completeness and disclaims any liability in connection with its use. The obligations of STL shall be only set forth in STL's standard terms and conditions of sale and in no case shall STL be liable for any incidental, indirect or consequential damages arising from the sale, resale, use or misuse of the product.

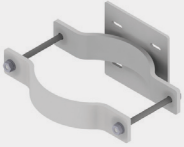
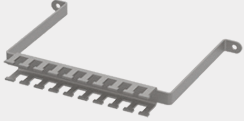
Users of STL products should make their own evaluation to determine the suitability of each product for the specific application.

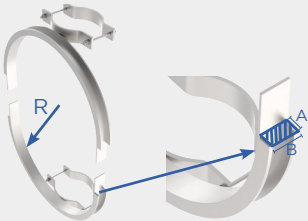
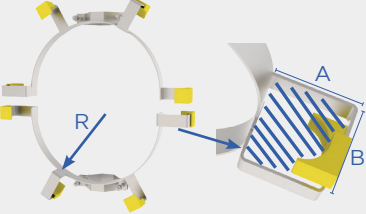
GUIDE TO MOUNTING BRACKETS AND CABLE STORAGE ODCKIT

KIT CODE AND IMAGE	KIT FEATURES
<p>CODCKIT-WMB</p> 	<p>COMPACT WALL MOUNTING BRACKET</p>
<p>ODCKIT-PMK</p> 	<p>POLE MOUNTING KIT</p> <p>This kit fixes ODCKIT-WMB [not included] to poles (pole diameter from 200mm to 100mm)</p>
<p>CODCKIT-CFP</p> 	<p>CABLE FIXING PLATE</p> <p>External extra fixing for tubes or heavy duty cables (1x with base A or 2x with base C) (1x ON CODCKIT-WMB)</p>
<p>CODCKIT-WMB TT</p> 	<p>CODCKIT-WMB FOR POWER LINE TRELLIS</p>
<p>MB-CODC2KIT</p> 	<p>MOUNTING BRACKET FOR MOBRA ARM</p> <p>Suitable for installation on standard MOBRA Arms</p>
<p>POLE MOUNTING SLACK STORAGE TYPE 01</p> 	<p>POLE COMPACT SLACK STORAGE FOR CABLES</p> <p>STORAGE AREA A=20mm B=38mm</p>
<p>POLE MOUNTING SLACK STORAGE TYPE 02</p> 	<p>POLE SLACK STORAGE FOR CABLES</p> <p>STORAGE AREA A= 105mm B= 100mm</p>
<p>CODCKIT-SGBP</p> 	<p>SHOT GUN BLASTER PROTECTION FOR CODC2 CLOSURES</p>

The information given herein, including the drawings, illustrations and schematics are intended for illustration purposes only and is believed reliable. However, STL makes no warranties to its accuracy or completeness and disclaims any liability in connection with its use. The obligations of STL shall be only set forth in STL's standard terms and conditions of sale and in no case shall STL be liable for any incidental, indirect or consequential damages arising from the sale, resale, use or misuse of the product.

Users of STL products should make their own evaluation to determine the suitability of each product for the specific application.