

Monport 40W Laser Engraver Controller Manual



**Read Carefully Before Use
Save It Well for Future Reference**

1. OVERVIEW

This GRBL controller is developed for Monport 40w CO₂ laser engraver & cutter and other 40w machines which can engrave and cut glass, leather, plastic, wood, etc. Its firmware and ports can also be used to control similar engravers from other manufacturers and some CNC machines. It can be taken as the replacement of Nano controller.

2. PRODUCT IMAGES

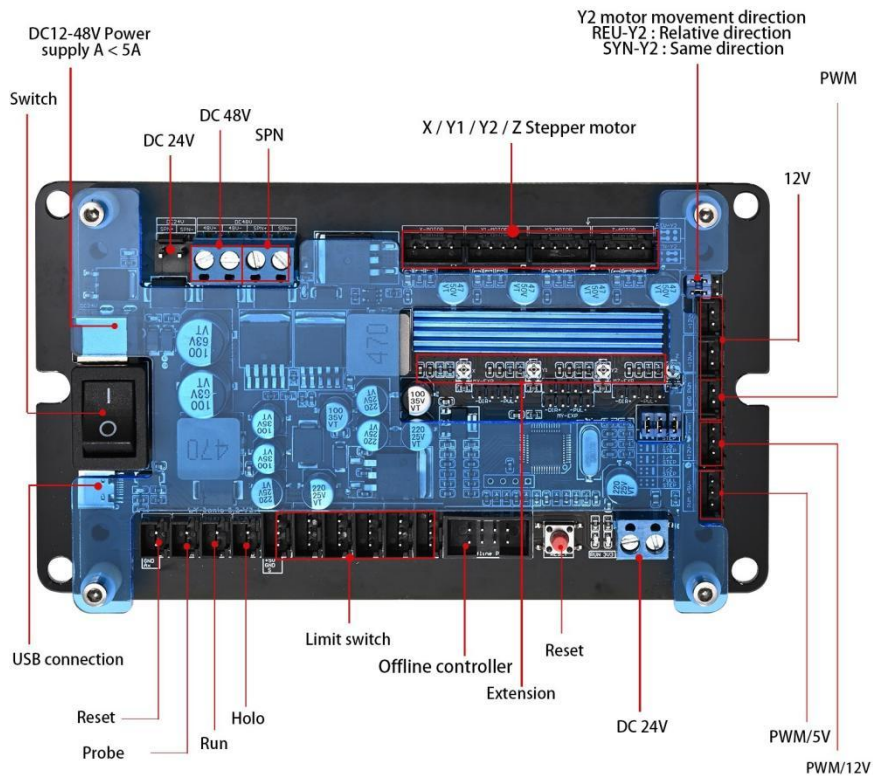

3. TECHNICAL SPECIFICATIONS

Model	40w laser engraver&cutter
CPU Type	MEGA328P/ Arduino
Board Dimensions	3.3"x5.9"x0.9" (8.5cmx15cmx2.35cm)
Input Power	24V
Output Power	5V / 12V / 24V
Support Axis	X, Y1, Y2, Z
Firmware	GRBL
Max. USB Speed	Mini USB 2.0
Compatible Software	Lightburn / LaserGRBL
Support Operating Systems	Windows / MacOS / Linux

4. PRODUCT DIAGRAM

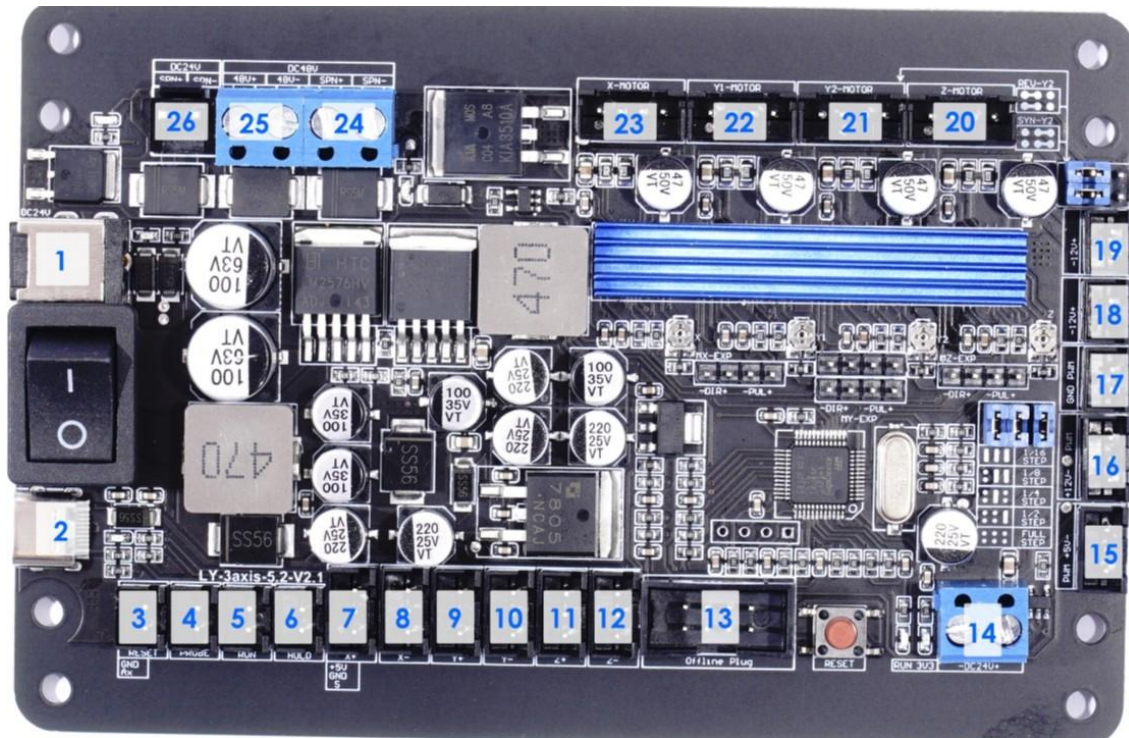

No.	Label	Pins	Use
1	DC	—	DC 12-48V power Supply
2	—	—	USB-C
3	Reset	2	Reset
4	Probe	2	Z axis height automatic detection
5	Run	2	Continue the process
6	Holo	2	Process the process
7	X+	3	X Axis Limit Switch
8	X-	3	X Axis Limit Switch
9	Y+	3	Y Axis Limit Switch
10	Y-	3	Y Axis Limit Switch
11	Z+	3	Z Axis Limit Switch
12	Z-	3	Z Axis Limit Switch
13	Offline plug	8	Offline control
14	DC 24V	2	DC output/input 24v
15	PWM/5V	3	5V Output Signals
16	PWM/12V	3	12V Output Signals
17	PWM	2	5V Output Signals
18	12V	2	5V Temp. Controller Signal
19	12V	2	5V Temp. Controller Signal
20	Z/motor	4	Z Axis Driver Signal
21	Y2/motor	4	Y2 Axis Driver Signal
22	Y1/motor	4	Y1 Axis Driver Signal
23	X/motor	4	X Axis Driver Signal
24	SPN	2	Trouble-locating
25	DC 48V	2	DC output 48V
26	DC 24V	2	DC output 24V

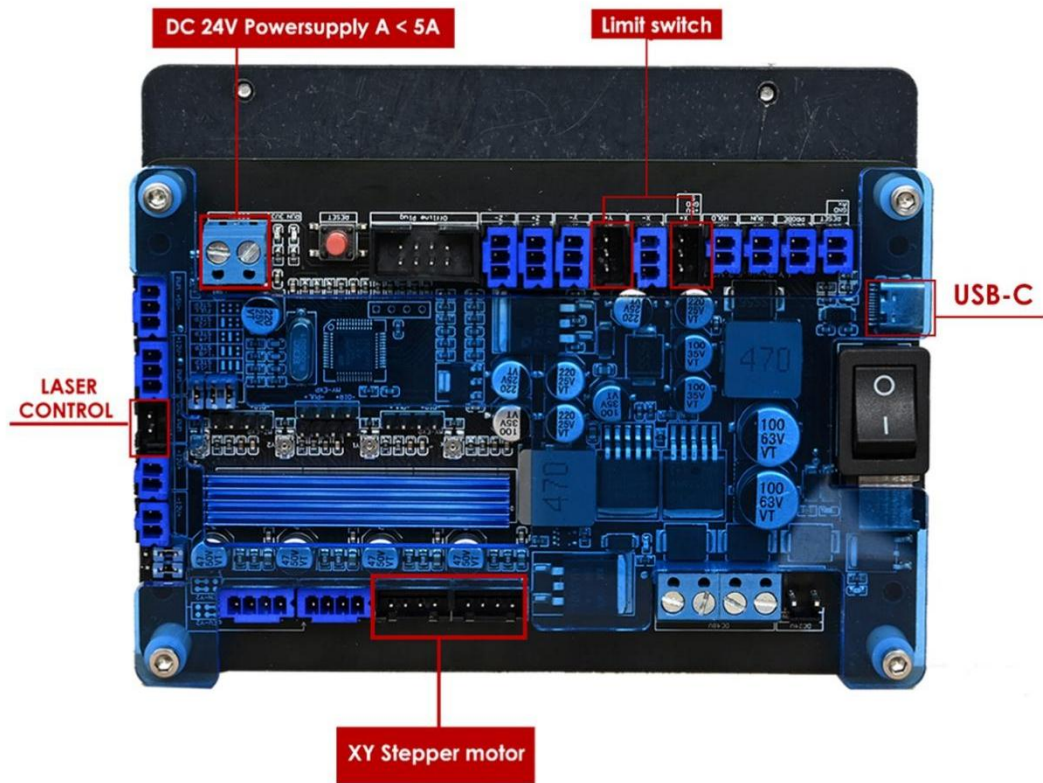

5. INSTALLATION

Step 1: Remove the old control board from the engraver, and place the new controller where the old one is.

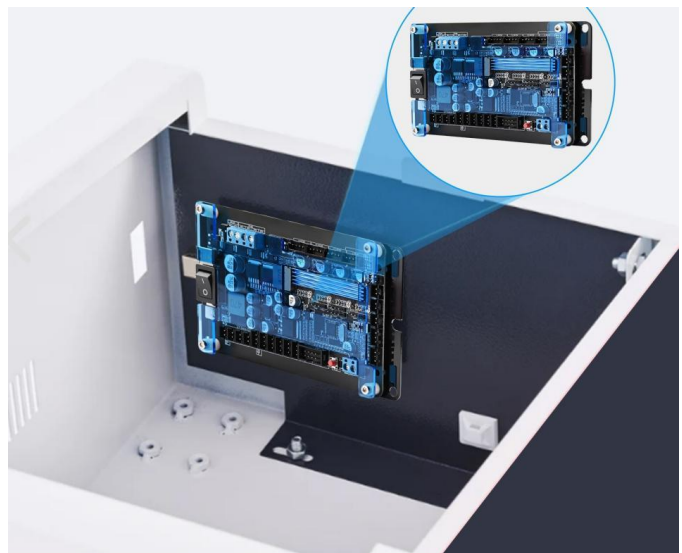

Step 2: Connect power supply to the control board.

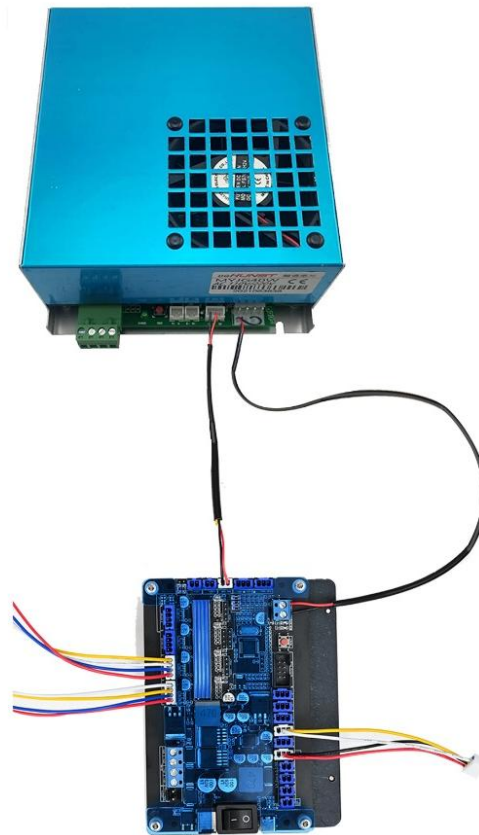

Step 3: Connect the machine with PC via a USB cable.

6. SOFTWARE CONFIGURATION

Step 1: Check out whether the USB cable is connected to the PC.

Step 2: Open the Lightburn Software.

Step 3: Choose the device.

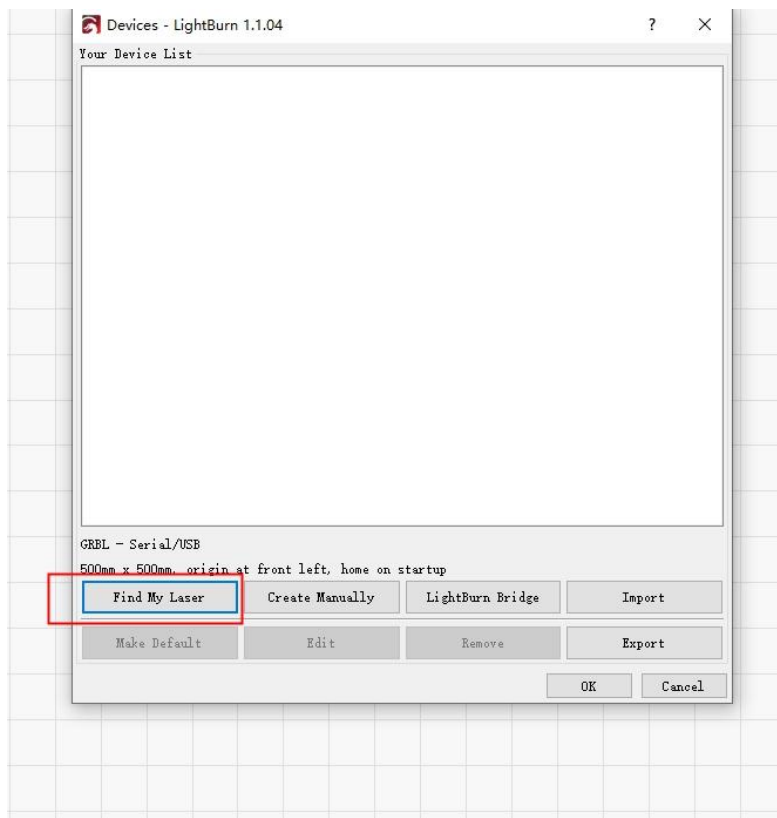
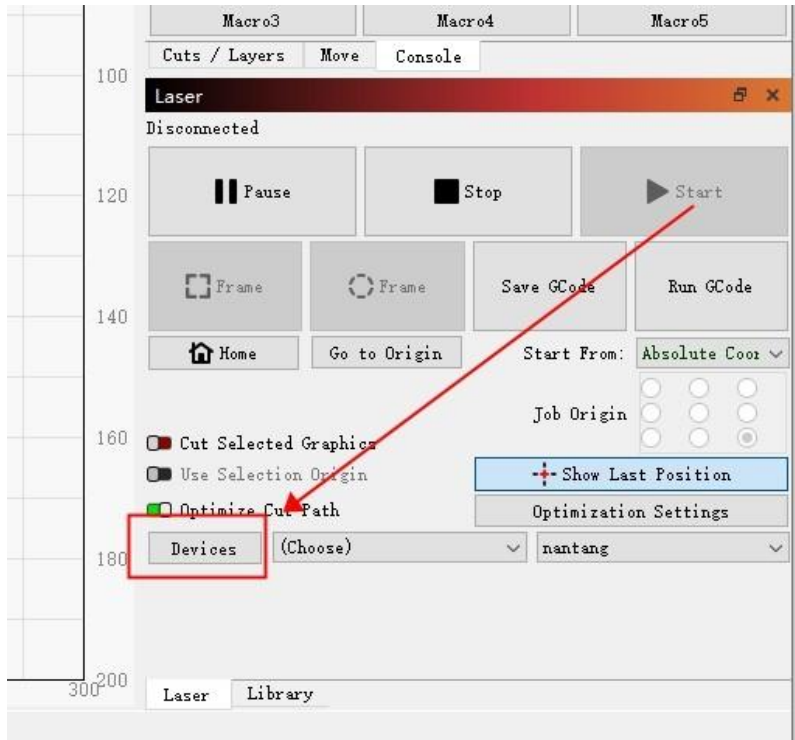

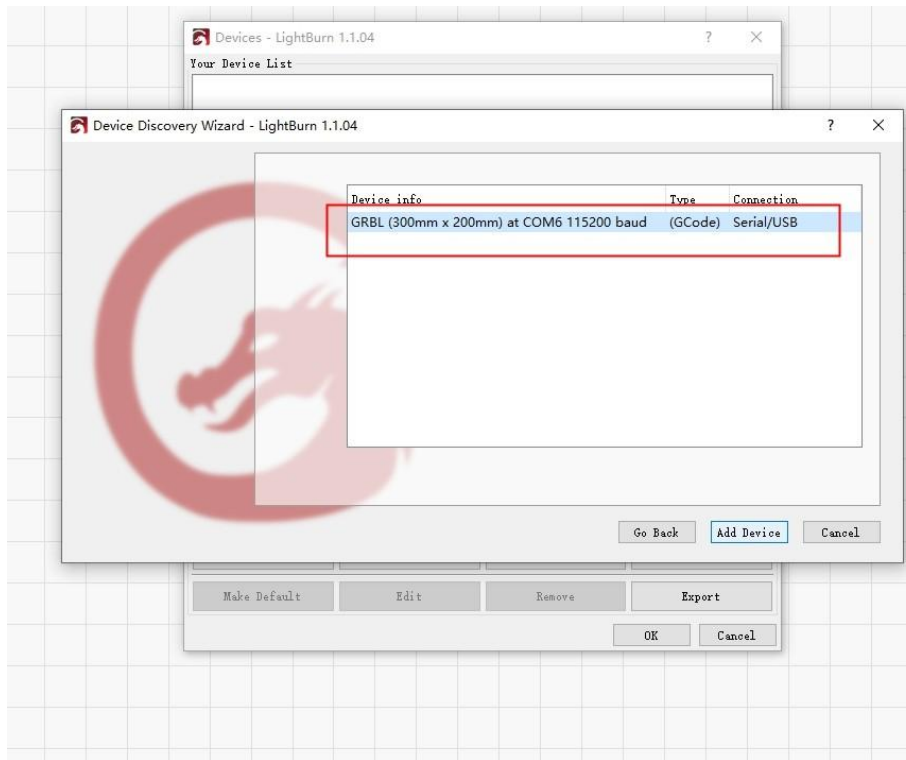

Step 4: Name whatever you like.

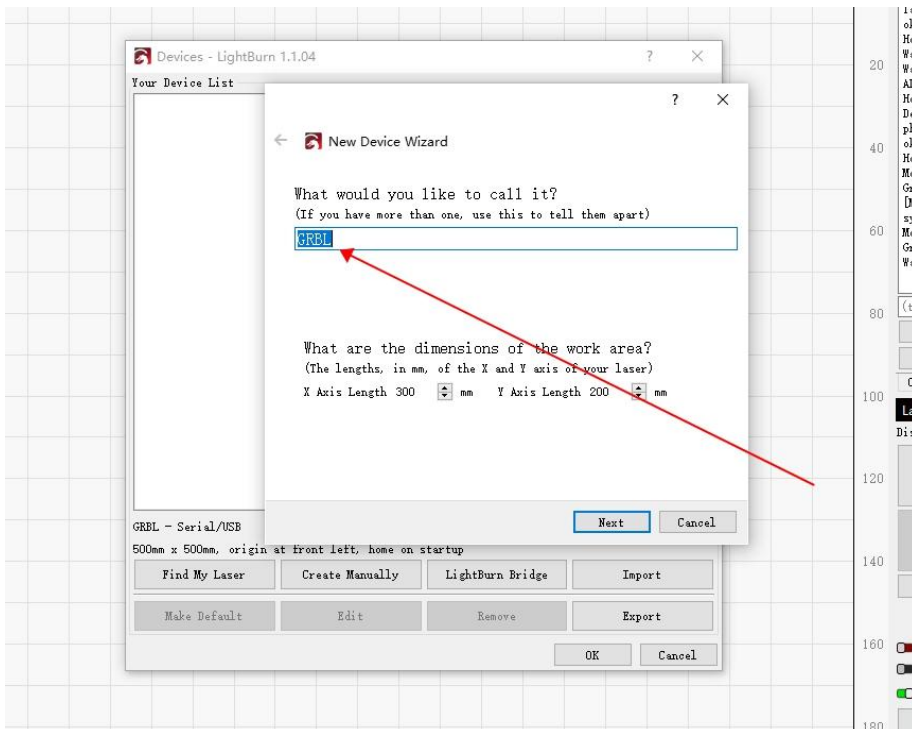

Step 5: Enjoy your new journey



7. CONTACT INFO

Thank you for choosing this controller to upgrade your 40w machine! Come and join in the Monport community at our official laser group on Facebook or visit the company forums at monportlaser.com! If you encounter any problem regarding your engraver, do not hesitate to contact customer service with your order number at help support@monportlaser.com. Our teams will respond within 24 hours to make things right. Thank you and we hope you will choose us again for all your laser needs.