

Rilettura in chiave destrutturata dell'estetica classica dei lampadari a sospensione. Mikado è un intreccio di linee e piani che producono un fluttuante movimento nello spazio generando figure geometriche semplici o complesse.

Le varie versioni a sospensione, lineari o circolari, permettono diversi gradi di personalizzazione ed elaborazione della struttura: sobria e minimalista o complessa ed eccentrica grazie alla sovrapposizione di piani ad altezze asimmetriche.

Le sorgenti a LED sono racchiuse in particolari metallici di forma conica, disponibili anche con diffusore in vetro soffiato satinato che impreziosisce ulteriormente la collezione.

A deconstructive reinterpretation of the classical aesthetics of pendant chandeliers. Mikado is a mixture of lines and planes that produce a fluctuating movement in space creating simple or complex geometric figures.

The various linear or circular pendant versions allow different degrees of customization and elaboration of the frame: simple and minimalist or complex and eccentric thanks to the overlapping planes at asymmetric heights. The LED sources are enclosed inside of conical metallic elements, available also with satin blown glass diffuser, further enriching the collection.

Eine unstrukturierte Neuinterpretation der klassischen Ästhetik von Hängelampen. Mikado ist ein Geflecht aus Linien und Ebenen das schwankende Bewegungen im Raum produziert, indem es einfache und komplexe Geometrie-Figuren erzeugt. Die verschiedenen Ausführungen der Abhängungen, linear oder kreisförmig, ermöglichen diverse Möglichkeiten der Personalisierung und Ausarbeitung der Struktur:

schlicht und minimalistisch, oder komplex und exzentrisch, dank der Überlappung der Ebenen in asymmetrischen Abständen. Die LED-Lichtquellen sind eingeschlossen in metallische Teile mit konischer Form. Erhältlich auch mit Diffusor aus satiniertem und geblasenen Glas, das die Kollektion nochmals erheblich aufwertet.

Relecture sous un jour déstructuré de l'esthétique classique des lustres à suspension. Mikado est un enchevêtrement de lignes et de plans qui produisent un mouvement fluctuant dans l'espace générant des figures géométriques simples ou complexes.

Les différentes versions à suspension, linéaires ou circulaires, permettent différents degrés de personnalisation et d'élaboration de la structure : sobre et minimaliste ou complexe et excentrique grâce à la superposition de plans à des hauteurs asymétriques.

Les sources à LED sont contenues dans des éléments métalliques de forme conique, également fournis avec un diffuseur en verre soufflé satiné qui enrichit ultérieurement la collection.

Relectura en clave descompuesta de la estética clásica de las lucernas suspendidas, Mikado es un enredo de líneas y planos que producen un movimiento oscilante en el espacio generando figuras geométricas simples y complejas.

Las varias versiones a suspensión, lineales o circulares, permiten varios grados de personalización y elaboración de la estructura: sobria y minimalista o compleja y excéntrica gracias a la sobreposición de planos de alturas asimétricas.

Las fuentes de LED están encerradas en detalles metálicos de forma cónica, disponibles incluso con difusor de vidrio soplado satinado que valoriza ulteriormente la colección.

Новая интерпретация в деструктивном ключе классической эстетики подвесных светильников.

Mikado – это переплетение линий и плоскостей, которые вызывает колеблющееся движение в пространстве, создавая простые и сложные геометрические фигуры.

Разнообразные версии подвесного светильника, как с линейным, так и с круговым расположением, позволяют разную степень персонализации и отделки структуры: строгую и минималистичную или, благодаря ассиметричному расположению плоскостей по высоте, сложную и эксцентричную. Источники LED заключены в металлические элементы конической формы, которые также могут быть предложены с рассеивателем из дугото сатинированного стекла, придающего коллекции дополнительную ценность.

Struttura: metallo nero opaco.

Frame: matt black metal.

Struktur: Metall, mattschwarz.

Structure: métal noir mat.

Estruttura: metal negro opaco.

Структура: металл, выполняется в черном матовом цвете.

Diffusore: vetro satinato.

Diffuser: satin glass.

Difusor: Satiniertes Glas.

Diffuseur: verre satiné.

Difusor: vidrio satinado.

Рассеиватель: Сатинированное стекло.

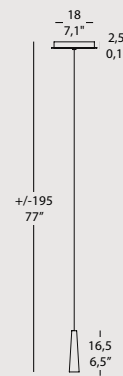
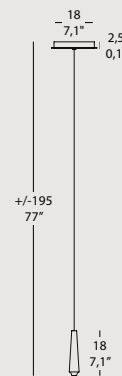
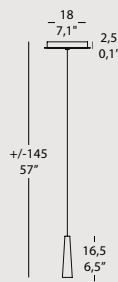
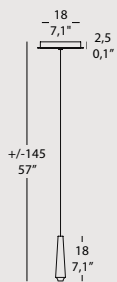

MIKADO SO 1 GLASS_S

1 x 3,2W 355 Lm 3000K Cri>80 220/240V

1 x 3,2W 335 Lm 2700K Cri>80 220/240V **LED**

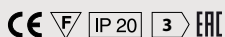

MIKADO SO 1_S

1 x 3,2W 355 Lm 3000K Cri>80 220/240V

1 x 3,2W 335 Lm 2700K Cri>80 220/240V **LED**

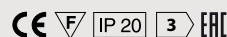

MIKADO SO 1 GLASS_L

1 x 3,2W 355 Lm 3000K Cri>80 220/240V

1 x 3,2W 335 Lm 2700K Cri>80 220/240V **LED**

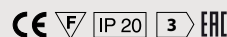

MIKADO SO 1_L

1 x 3,2W 355 Lm 3000K Cri>80 220/240V

1 x 3,2W 335 Lm 2700K Cri>80 220/240V **LED**

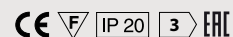

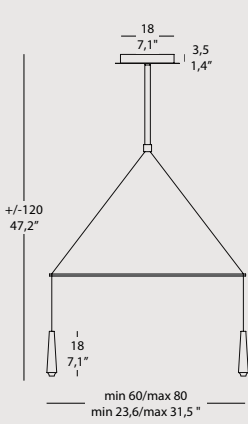

MIKADO S2L GLASS_S

2 x 3,2W 710 Lm 3000K Cri>80 220/240V
2 x 3,2W 670 Lm 2700K Cri>80 220/240V **LED**

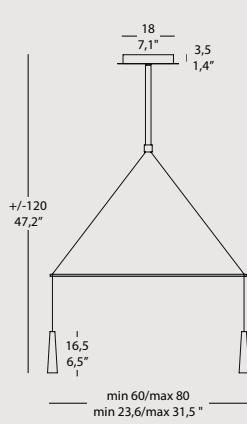
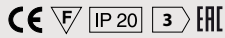

MIKADO S2L_S

2 x 3,2W 710 Lm 3000K Cri>80 220/240V
2 x 3,2W 670 Lm 2700K Cri>80 220/240V **LED**

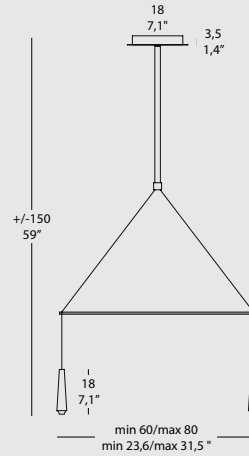
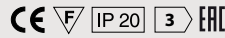

MIKADO S2L GLASS_L

2 x 3,2W 710 Lm 3000K Cri>80 220/240V
2 x 3,2W 670 Lm 2700K Cri>80 220/240V **LED**

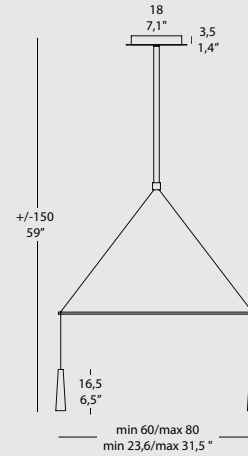
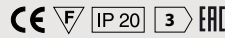

MIKADO S2L_L

2 x 3,2W 710 Lm 3000K Cri>80 220/240V
2 x 3,2W 670 Lm 2700K Cri>80 220/240V **LED**

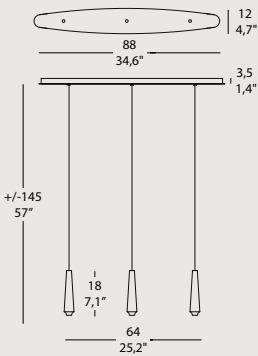
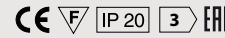

MIKADO S3L GLASS_S

3 x 3,2W 1065 Lm 3000K Cri>80 220/240V
3 x 3,2W 1005 Lm 2700K Cri>80 220/240V **LED**

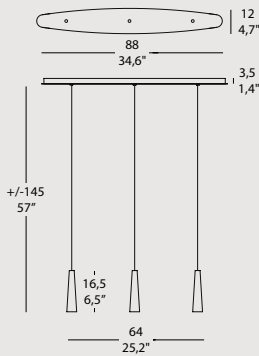
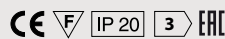

MIKADO S3L_S

3 x 3,2W 1065 Lm 3000K Cri>80 220/240V
3 x 3,2W 1005 Lm 2700K Cri>80 220/240V **LED**

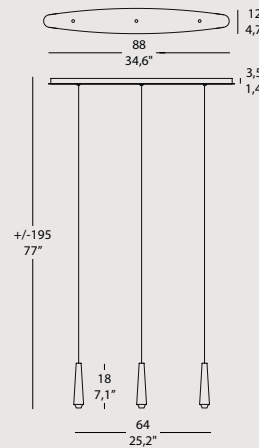
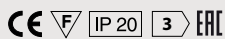

MIKADO S3L GLASS_L

3 x 3,2W 1065 Lm 3000K Cri>80 220/240V
3 x 3,2W 1005 Lm 2700K Cri>80 220/240V **LED**

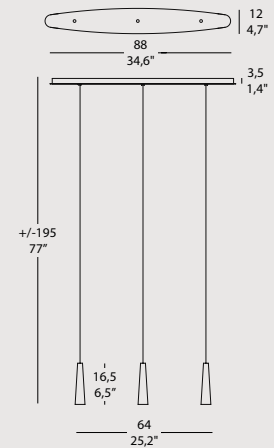

MIKADO S3L_L

3 x 3,2W 1065 Lm 3000K Cri>80 220/240V
3 x 3,2W 1005 Lm 2700K Cri>80 220/240V **LED**

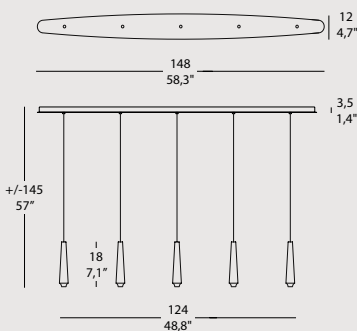

MIKADO S5L GLASS_S

5 x 3,2W 1775 Lm 3000K Cri>80 220/240V
5 x 3,2W 1675 Lm 2700K Cri>80 220/240V **LED**

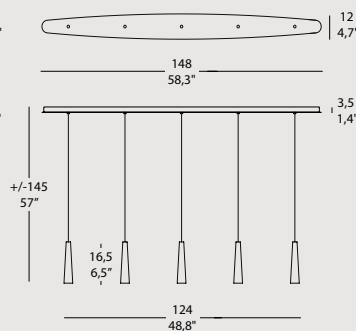

MIKADO S5L_S

5 x 3,2W 1775 Lm 3000K Cri>80 220/240V
5 x 3,2W 1675 Lm 2700K Cri>80 220/240V **LED**

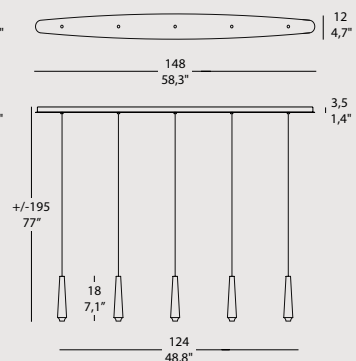
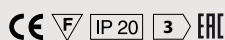

MIKADO S5L GLASS_L

5 x 3,2W 1775 Lm 3000K Cri>80 220/240V
5 x 3,2W 1675 Lm 2700K Cri>80 220/240V **LED**

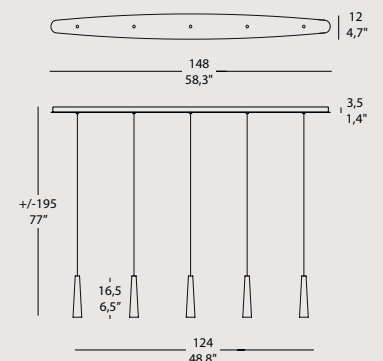
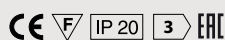

MIKADO S5L_L

5 x 3,2W 1775 Lm 3000K Cri>80 220/240V
5 x 3,2W 1675 Lm 2700K Cri>80 220/240V **LED**

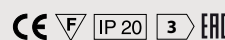

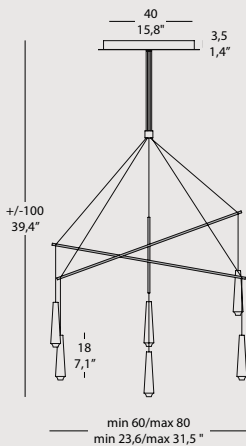

MIKADO LA 6 GLASS_S

6 x 3,2W 2130 Lm 3000K Cri>80 220/240V

6 x 3,2W 2010 Lm 2700K Cri>80 220/240V **LED**

MIKADO LA 6 GLASS_S DIM PD

6 x 3,2W 2130 Lm 3000K Cri>80 220/240V

6 x 3,2W 2010 Lm 2700K Cri>80 220/240V

con driver dimmerabile push/with push dimmable driver 220/240V **LED**

CE F IP20 3 EAC

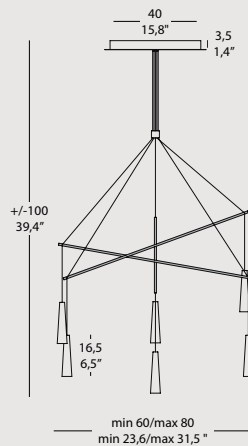

MIKADO LA 6_S

6 x 3,2W 2130 Lm 3000K Cri>80 220/240V

6 x 3,2W 2010 Lm 2700K Cri>80 220/240V **LED**

MIKADO LA 6_S DIM PD

6 x 3,2W 2130 Lm 3000K Cri>80 220/240V

6 x 3,2W 2010 Lm 2700K Cri>80 220/240V

con driver dimmerabile push/with push dimmable driver 220/240V **LED**

CE F IP20 3 EAC

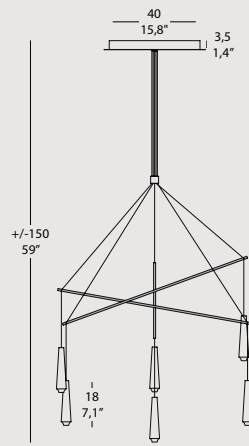

MIKADO LA 6 GLASS_L

6 x 3,2W 2130 Lm 3000K Cri>80 220/240V

6 x 3,2W 2010 Lm 2700K Cri>80 220/240V **LED**

MIKADO LA 6 GLASS_L DIM PD

6 x 3,2W 2130 Lm 3000K Cri>80 220/240V

6 x 3,2W 2010 Lm 2700K Cri>80 220/240V

con driver dimmerabile push/with push dimmable driver 220/240V **LED**

CE F IP20 3 EAC

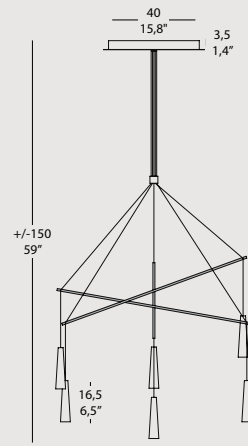

MIKADO LA 6_L

6 x 3,2W 2130 Lm 3000K Cri>80 220/240V

6 x 3,2W 2010 Lm 2700K Cri>80 220/240V **LED**

MIKADO LA 6_L DIM PD

6 x 3,2W 2130 Lm 3000K Cri>80 220/240V

6 x 3,2W 2010 Lm 2700K Cri>80 220/240V

con driver dimmerabile push/with push dimmable driver 220/240V **LED**

CE F IP20 3 EAC

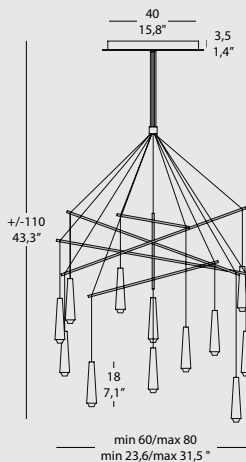

MIKADO LA 12 GLASS_S

12 x 3,2W 4260 Lm 3000K Cri>80 220/240V

12 x 3,2W 4020 Lm 2700K Cri>80 220/240V **LED**

MIKADO LA 12 GLASS_S DIM PD

12 x 3,2W 4260 Lm 3000K Cri>80 220/240V

12 x 3,2W 4020 Lm 2700K Cri>80 220/240V

con driver dimmerabile push/with push dimmable driver 220/240V **LED**

CE F IP20 3 EAC

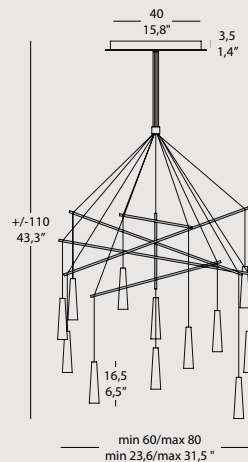

MIKADO LA 12_S

12 x 3,2W 4260 Lm 3000K Cri>80 220/240V

12 x 3,2W 4020 Lm 2700K Cri>80 220/240V **LED**

MIKADO LA 12_S DIM PD

12 x 3,2W 4260 Lm 3000K Cri>80 220/240V

12 x 3,2W 4020 Lm 2700K Cri>80 220/240V

con driver dimmerabile push/with push dimmable driver 220/240V **LED**

CE F IP20 3 EAC

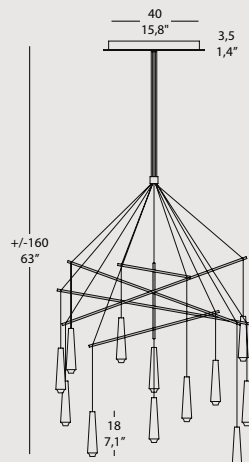

MIKADO LA 12 GLASS_L

12 x 3,2W 4260 Lm 3000K Cri>80 220/240V

12 x 3,2W 4020 Lm 2700K Cri>80 220/240V **LED**

MIKADO LA 12 GLASS_L DIM PD

12 x 3,2W 4260 Lm 3000K Cri>80 220/240V

12 x 3,2W 4020 Lm 2700K Cri>80 220/240V

con driver dimmerabile push/with push dimmable driver 220/240V **LED**

CE F IP20 3 EAC

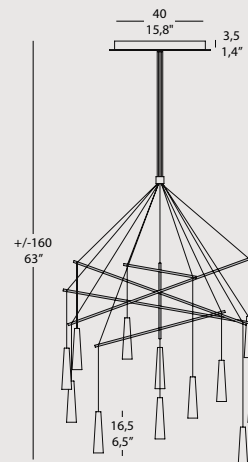

MIKADO LA 12_L

12 x 3,2W 4260 Lm 3000K Cri>80 220/240V

12 x 3,2W 4020 Lm 2700K Cri>80 220/240V **LED**

MIKADO LA 12_L DIM PD

12 x 3,2W 4260 Lm 3000K Cri>80 220/240V

12 x 3,2W 4020 Lm 2700K Cri>80 220/240V

con driver dimmerabile push/with push dimmable driver 220/240V **LED**

CE F IP20 3 EAC

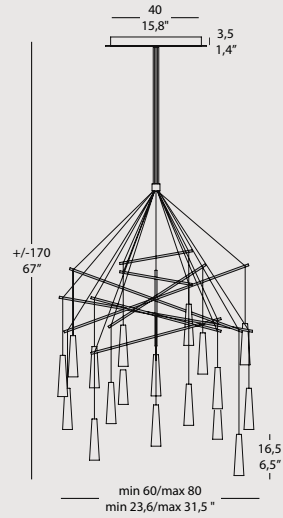
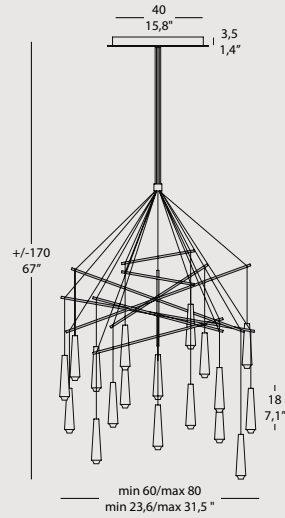
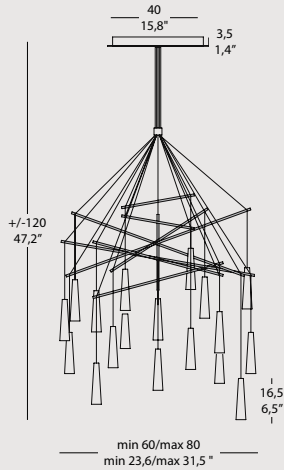
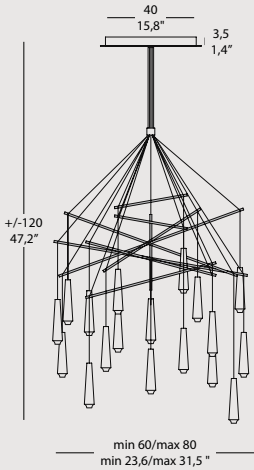

MIKADO LA 18 GLASS_S

18 x 3,2W 6390 Lm 3000K Cri>80 220/240V
18 x 3,2W 6030 Lm 2700K Cri>80 220/240V **LED**

MIKADO LA 18 GLASS_S DIM PD

18 x 3,2W 6390 Lm 3000K Cri>80 220/240V
18 x 3,2W 6030 Lm 2700K Cri>80 220/240V
con driver dimmerabile push/with push dimmable driver 220/240V **LED**



MIKADO LA 18_S

18 x 3,2W 6390 Lm 3000K Cri>80 220/240V
18 x 3,2W 6030 Lm 2700K Cri>80 220/240V **LED**

MIKADO LA 18_S DIM PD

18 x 3,2W 6390 Lm 3000K Cri>80 220/240V
18 x 3,2W 6030 Lm 2700K Cri>80 220/240V
con driver dimmerabile push/with push dimmable driver 220/240V **LED**

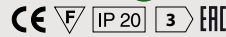

MIKADO LA 18 GLASS_L

18 x 3,2W 6390 Lm 3000K Cri>80 220/240V
18 x 3,2W 6030 Lm 2700K Cri>80 220/240V **LED**

MIKADO LA 18 GLASS_L DIM PD

18 x 3,2W 6390 Lm 3000K Cri>80 220/240V
18 x 3,2W 6030 Lm 2700K Cri>80 220/240V
con driver dimmerabile push/with push dimmable driver 220/240V **LED**

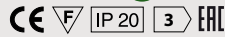

MIKADO LA 18_L

18 x 3,2W 6390 Lm 3000K Cri>80 220/240V
18 x 3,2W 6030 Lm 2700K Cri>80 220/240V **LED**

MIKADO LA 18_L DIM PD

18 x 3,2W 6390 Lm 3000K Cri>80 220/240V
18 x 3,2W 6030 Lm 2700K Cri>80 220/240V
con driver dimmerabile push/with push dimmable driver 220/240V **LED**



**SU RICHIESTA È POSSIBILE AVERE ANCHE DRIVER DIMMERABILE 1/10V
1/10V DIMMABLE DRIVER CAN BE SUPPLIED BY REQUEST**

**BARRA/BAR 50
NERO/BLACK**

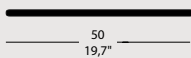

**BARRA/BAR 75
NERO/BLACK**

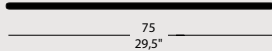

DIFFUSORE/DIFFUSER

