

# Mom Family

Umberto Asnago  
2016

1602-24

Collection of lamps in five shapes made in borosilicate glass: Mat finishes: blue avio, sage green, powder pink, sand, white. Glossy finishes: green, blue, violet.



<b>Mounting</b>	Suspension
<b>Environment</b>	Indoor
<b>Materials</b>	Borosilicate glass
<b>Voltage</b>	230V 50/60Hz
<b>Source</b>	1x 5W LED - E14
<b>Lumen</b>	NA
<b>Dimming</b>	NA

## Glass finishes

Matt white	Matt sage green	Glossy blue
Matt sand	Matt blue avio	Glossy violet
Matt black	Matt powder pink	Glossy green
Matt mustard		

## Canopy finishes

White
Titanium

## Certification

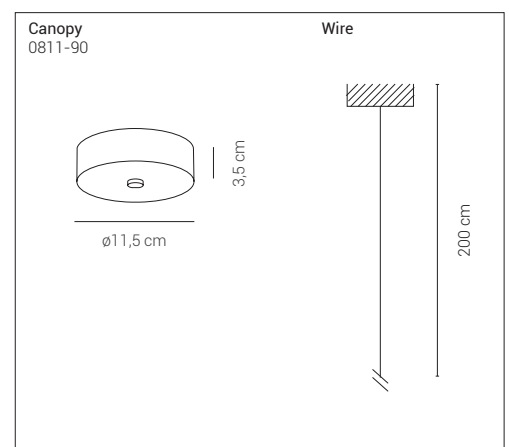
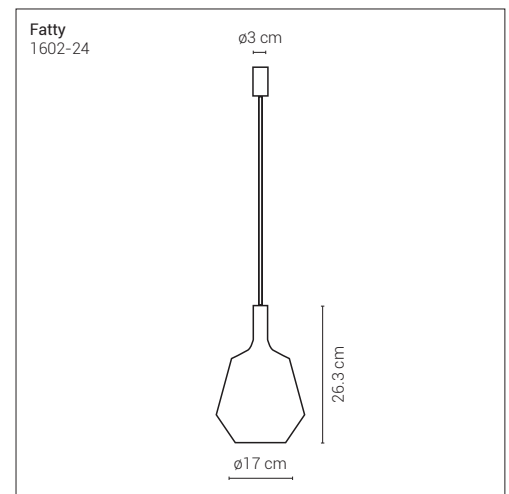

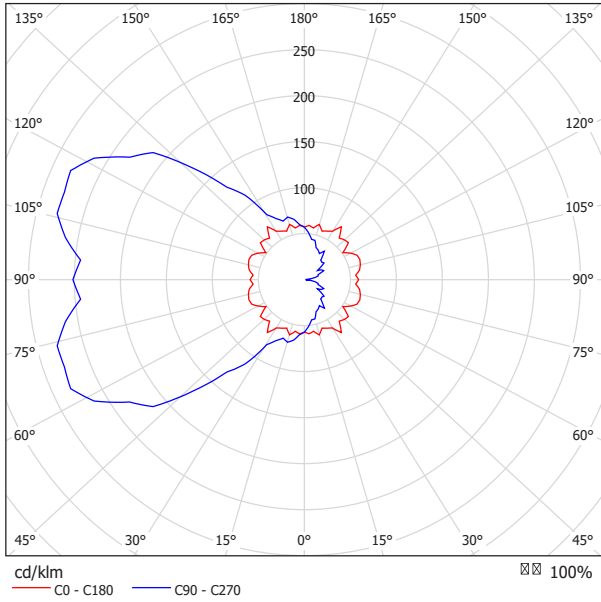

**MoM fatty glossy violet**

# Mom Family

Umberto Asnago  
2016











1602-23

Collection of lamps in five shapes made in borosilicate glass: Matt finishes: blue avio, sage green, powder pink, sand, white. Glossy finishes: green, blue, violet.



<b>Mounting</b>	Suspension
<b>Environment</b>	Indoor
<b>Materials</b>	Borosilicate glass
<b>Voltage</b>	230V 50/60Hz
<b>Source</b>	1x 10W LED - E27
<b>Lumen</b>	NA
<b>Dimming</b>	NA

## Glass finishes

 Matt white	 Matt sage green	 Glossy blue
 Matt sand	 Matt blue avio	 Glossy violet
 Matt black	 Matt powder pink	 Glossy green
 Matt mustard		

## Canopy finishes

 White
 Titanium

## Certification

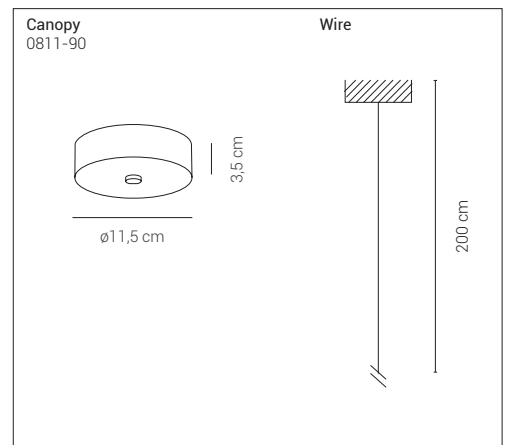
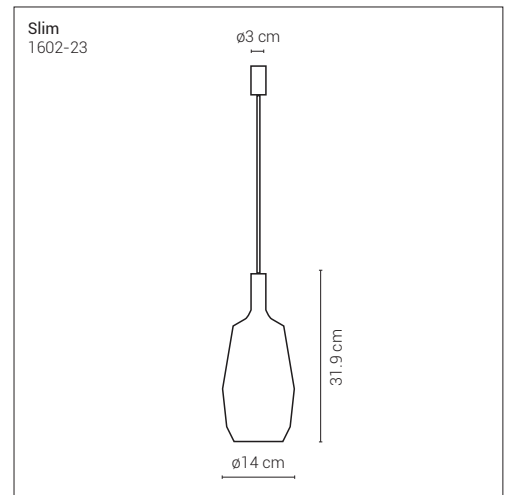

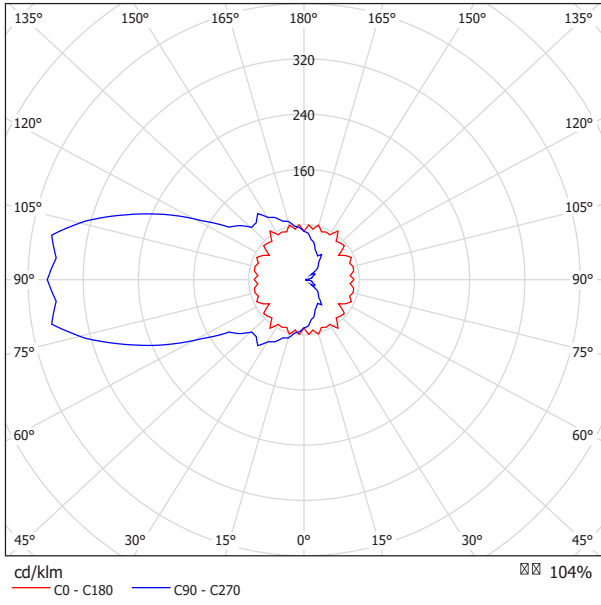

MoM fatty glossy violet

# Mom Family

Umberto Asnago  
2016

1602-25

Collection of lamps in five shapes made in borosilicate glass: Matt finishes: blue avio, sage green, powder pink, sand, white. Glossy finishes: green, blue, violet.



<b>Mounting</b>	Suspension
<b>Environment</b>	Indoor
<b>Materials</b>	Borosilicate glass
<b>Voltage</b>	230V 50/60Hz
<b>Source</b>	1x 5W LED - E14
<b>Lumen</b>	NA
<b>Dimming</b>	NA

## Glass finishes

Matt white	Matt sage green	Glossy blue
Matt sand	Matt blue avio	Glossy violet
Matt black	Matt powder pink	Glossy green
Matt mustard		

## Canopy finishes

White
Titanium

## Certification

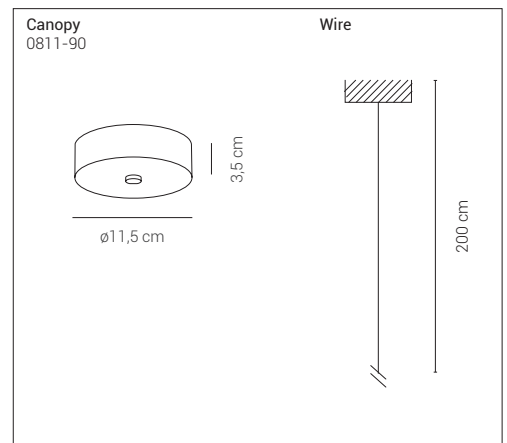
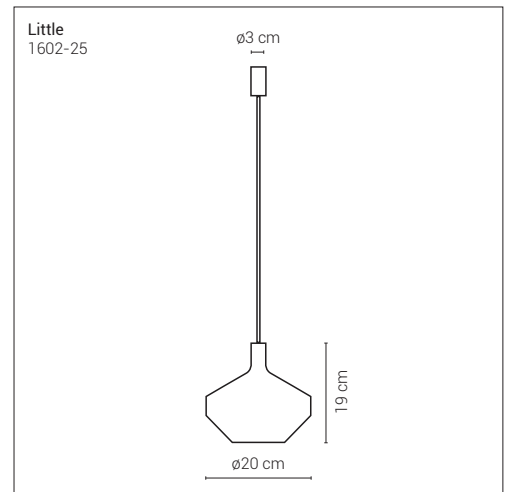

# Mom Family

Umberto Asnago  
2016

1602-21

Collection of lamps in five shapes made in borosilicate glass: Mat finishes: blue avio, sage green, powder pink, sand, white. Glossy finishes: green, blue, violet.



<b>Mounting</b>	Suspension
<b>Environment</b>	Indoor
<b>Materials</b>	Borosilicate glass
<b>Voltage</b>	230V 50/60Hz
<b>Source</b>	1x 10W LED - E27
<b>Lumen</b>	NA
<b>Dimming</b>	NA

## Glass finishes

Matt white	Matt sage green	Glossy blue
Matt sand	Matt blue avio	Glossy violet
Matt black	Matt powder pink	Glossy green
Matt mustard		

## Canopy finishes

White
Titanium

## Certification

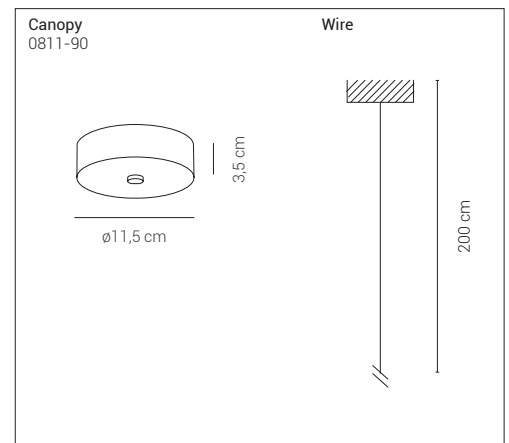
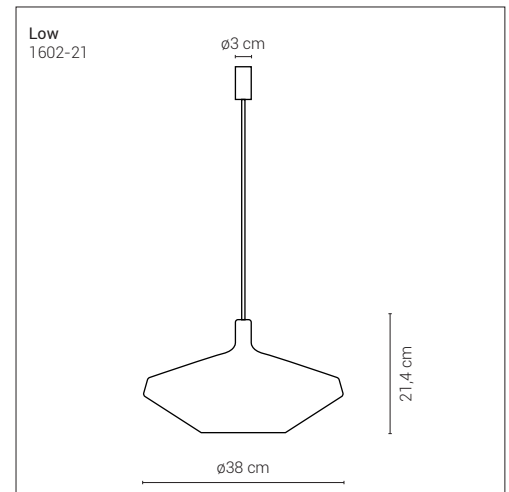

# Mom Family

Umberto Asnago  
2016

1602-22

Collection of lamps in five shapes made in borosilicate glass: Mat finishes: blue avio, sage green, powder pink, sand, white. Glossy finishes: green, blue, violet.



<b>Mounting</b>	Suspension
<b>Environment</b>	Indoor
<b>Materials</b>	Borosilicate glass
<b>Voltage</b>	230V 50/60Hz
<b>Source</b>	1x 10W LED - E27
<b>Lumen</b>	NA
<b>Dimming</b>	NA

## Glass finishes

Matt white	Matt sage green	Glossy blue
Matt sand	Matt blue avio	Glossy violet
Matt black	Matt powder pink	Glossy green
Matt mustard		

## Canopy finishes

White
Titanium

## Certification

