



SIRCLE, a symbolization merged Square and Circle, inspired by the East aesthetic philosophy, the circular light ball just like a soft tender mind leans on the rigid prudent frame, chemically shaped a harmonious feature with its flexible body inside-out. Meanwhile, the fantastic performance of light through the opal mouth-blown glass, spreading the beauty of moonlight all over the space.

By Li, Hui Lun 李慧倫





champagne gold



matt black

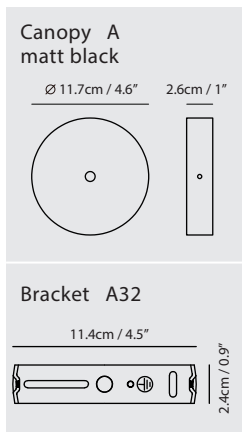
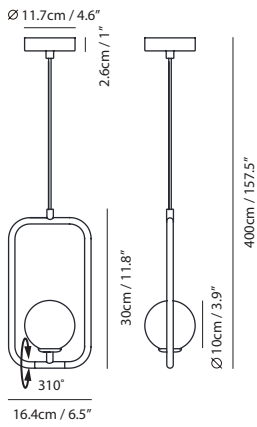



Sircle Pendant S

Model
SG-100PV

Material
mouth-blown glass, steel

Light Source
G9 1 x 3W LED 2700K CRI90

Weight
0.8kg / 1.8lb

- Color**
-  matt opal + champagne gold
 -  matt opal + matt black

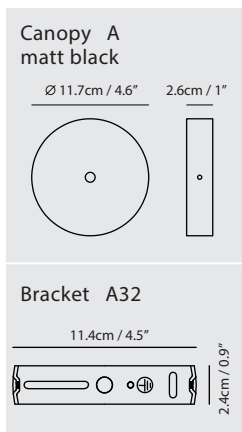
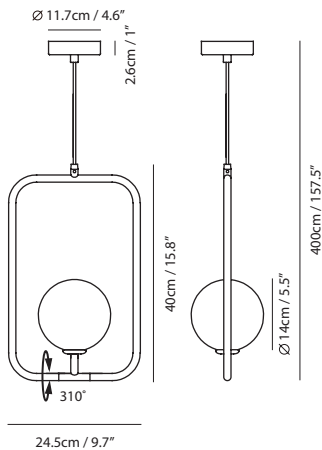



Sircle Pendant L

Model
SG-140PV

Material
mouth-blown glass, steel

Light Source
G9 1 x 5W LED 2700K CRI90

Weight
1.6kg / 3.5lb

- Color**
-  matt opal + champagne gold
 -  matt opal + matt black





champagne gold



matt black

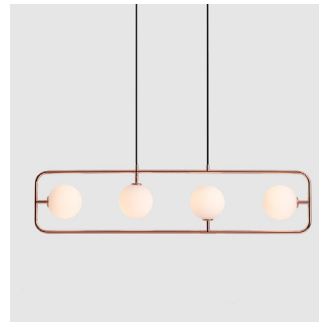

copper

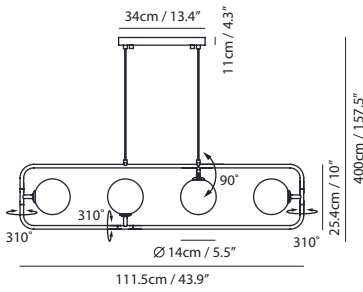

Canopy C16
matt black

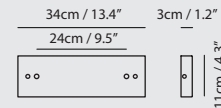

Bracket A31

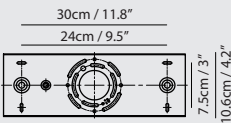

Sircle Pendant PH4



Model
SG-140PH4

Material
mouth-blown glass, steel

Light Source
G9 4 x 5W LED 2700K CRI90

Weight
5.0kg / 11lb

Color

-  matt opal + champagne gold
-  matt opal + matt black
-  matt opal + copper





champagne gold

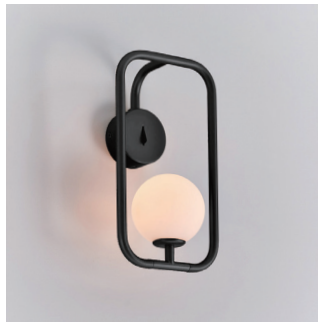

matt black

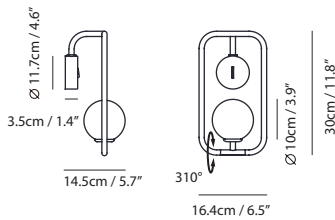

Canopy A64
champagne gold
matt black

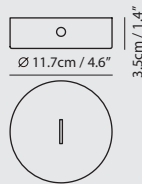

Bracket B4

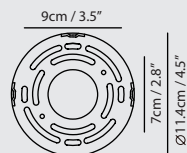



Sircle Wall

Model
SG-100WV

Material
mouth-blown glass, steel

Light Source
G9 1 x 3W LED 2700K CRI90

Weight
1.1kg / 2.4lb

Color
 matt opal + champagne gold
 matt opal + matt black

* Fixture can be installed horizontally, or vertically, in both directions, offering a high degree of flexibility.