

BLACK OUT suspension

Matteo Ugolini design

year 2015

TECHNICAL SHEET - SE101 2B V11

STRUCTURE "A"

material fiberglass
colour white



CEILING CUP "E"

material metal
colour matt white

ELECTRICAL CABLE "C"

material PVC
colour transparent



SUSPENSION CABLE "F"

material steel

ELECTRICAL SYSTEM

socket E26
source max 3x18w LED
energy class from E to A++





PACKAGING

nr. of collis 1
net weight/kg 1,5
gross weight/kg 3,9
packaging/cm 60x60x70

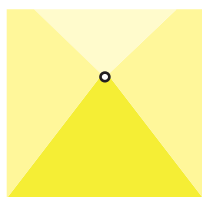
EMISSION OF LIGHT

one-directional



 direct
 filtered
 indirect
 none

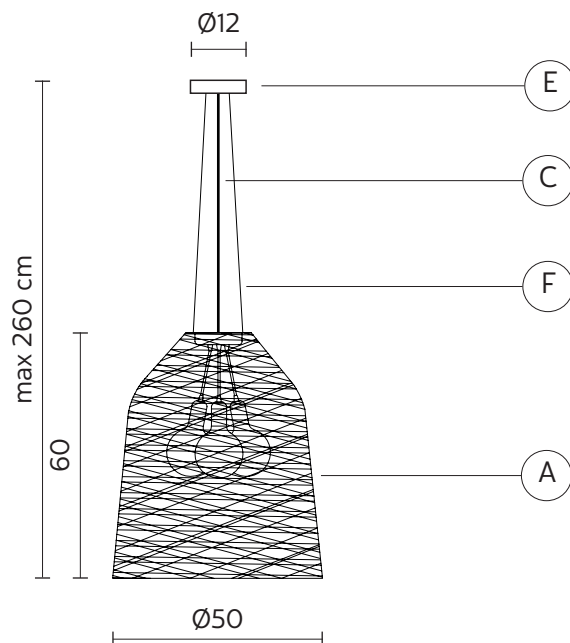

COLLECTION

available also as floor lamp

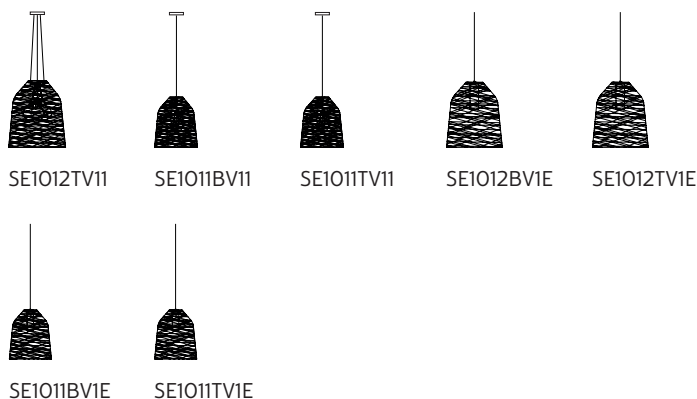

CERTIFICATION



bulb not provided